

Instruction Manual

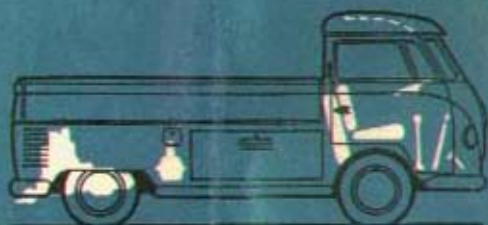

Transporter

F E B R U A R Y 1 9 6 2

INSTRUCTION MANUAL

VW TRANSPORTER

CONTENTS

Introduction	3
Controls and Instruments	5
Operating Instructions	9
Practical Driving	21
Cold Weather Hints.....	26
Lubrication	29
Wheels and Tires	38
Care of the VW Transporter	41
Maintenance	45
General Description	65
Technical Data	69
Bulb Chart	73
Lubrication Chart	75
Maintenance Chart	76
Index	77
Tools and Accessories	Inside Back Cover

VOLKSWAGENWERK AG WOLFSBURG
Germany



We are sure that the excellent performance and economical operation of your VW Transporter will justify the confidence you have placed in our firm when purchasing this vehicle.

This Manual sets out in full the information necessary for the proper operation, care and general maintenance of your VW Transporter. In addition, interesting specification details have been included to familiarize you with the construction and mechanical details of this fine piece of mechanism.

No effort has been spared to produce an efficient and reliable automobile. This Instruction Manual can help you obtain lasting satisfaction in the operation of your VW Transporter. All information contained in this handbook is based on the actual experience of many years.

In order to maintain maximum efficiency, we particularly stress the importance of following the recommendations set out in this manual. The intimate knowledge obtained by studying this manual will assure you of the utmost service and satisfaction from your VW Transporter.

Regular attention to proper lubrication and maintenance of your vehicle is important. An extensive network of VW Dealers exists throughout the world, and you will readily recognize such stations by the familiar blue VW SERVICE sign. These Dealers are in constant contact with the Volkswagenwerk through our field engineers, thus providing skillful and expert performance of any job to be done. You'll enjoy many more miles of trouble-free driving by giving your VW Transporter just ordinary care.

All experienced VW owners know the value of preventive maintenance. Care and maintenance will be amply rewarded in the long run.

Make the most of your VW TRANSPORTER

V O L K S W A G E N W E R K A G



CONTROLS AND INSTRUMENTS

The first thing you must do is become familiar with the controls and instruments of your new VW Transporter. Sit behind the wheel, make yourself comfortable, and get acquainted with all the various levers, switches and controls. Some of the features you may already know. Check your present knowledge against this complete list.

THE VEHICLE KEYS

Only one key is required for the locks in the vehicle doors and rear panel and to operate the starter-ignition lock (7). If your vehicle is equipped with a steering-ignition lock you will receive a second key. It is advisable to make a note of the key numbers and keep it with the vehicle documents. If a key is lost, you can then quote the number when ordering a replacement from your VW Dealer.



INSTRUMENTS:

- 1 - Fuel gauge
- 2 - Speedometer and mileage recorder
- 3 - Warning light - Red - Generator and cooling
- 4 - Warning light - Blue - Headlight high beam
- 5 - Warning light - Green - Flashing indicators
- 6 - Warning light - Green - Oil pressure

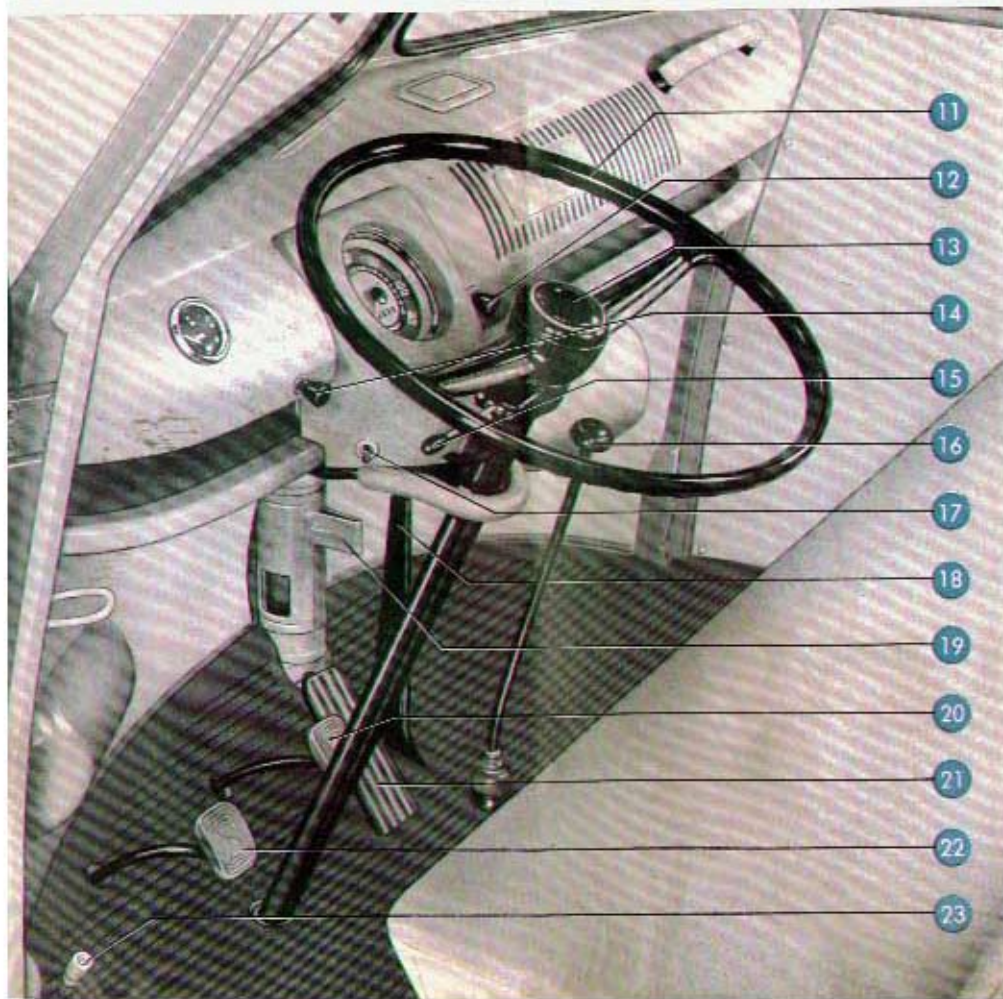
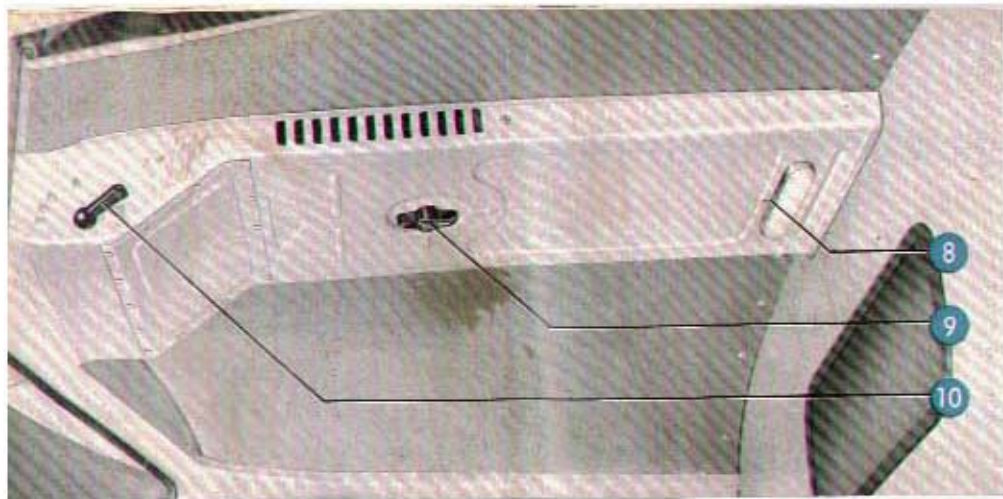

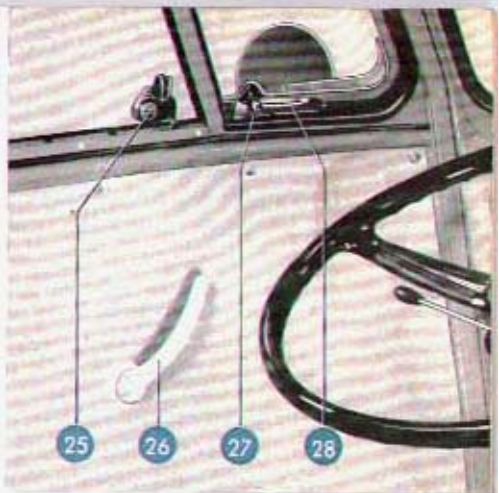
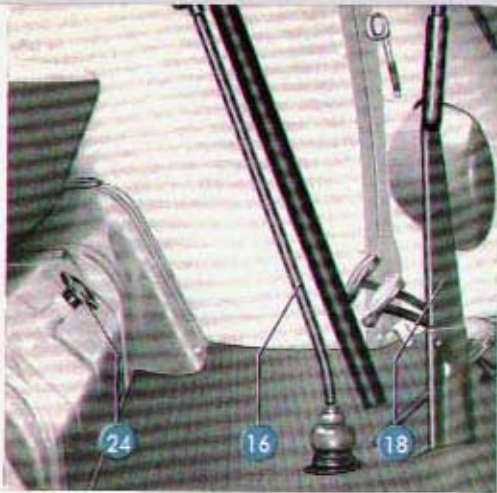

HAND CONTROLS:

- 7 - Combined ignition and starting switch (page 5)
- 8 - Cab lamp switch
- 9 - Fresh air deflector handle
- 10 - Operating lever for fresh air regulator
- 11 - Steering wheel
- 12 - Headlight and instrument light switch
- 13 - Horn button
- 14 - Windshield wiper switch
- 15 - Flashing indicator lever
- 16 - Gear lever
- 17 - Tumbler switch for loading compartment lamp
- 18 - Hand brake lever
- 19 - Hot air distributor
- 24 - Heating control
- 25 - Sliding glass panel catch
- 26 - Inside door handle
- 27 - Vent wing lock release button
- 28 - Vent wing lock

FOOT CONTROLS :

- 20 - Brake pedal
- 21 - Accelerator pedal
- 22 - Clutch pedal
- 23 - Headlight dimmer switch

Among the papers which come with your vehicle you will find details regarding the model, year of construction, and chassis and engine numbers. The Police or Traffic Department may check whether or not the information on the papers corresponds exactly with that on your vehicle.

THE CHASSIS NUMBER

is stamped on the engine cover plate near the battery.

THE IDENTIFICATION PLATE

is found on the vertical surface to the right of the engine.

THE ENGINE NUMBER

is on the crankcase flange for the generator support.

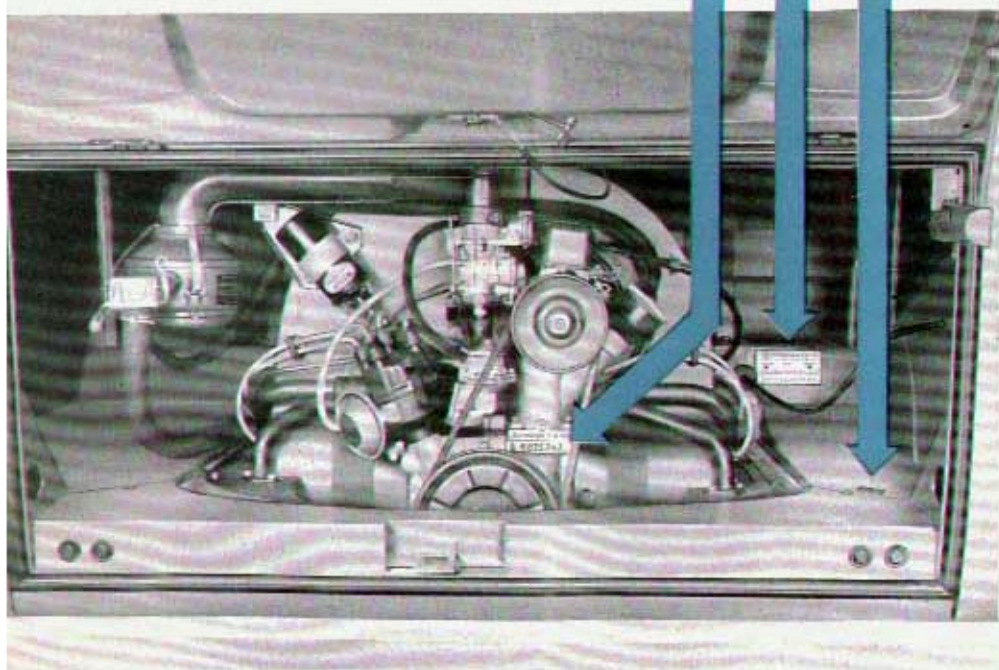

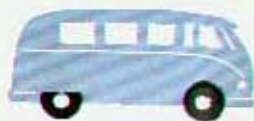

OPERATING INSTRUCTIONS

BEFORE YOU DRIVE AWAY

please check

- engine oil level
- fan belt tension
- quantity of fuel in the tank
- tire pressures
- efficiency of brakes
- position of rear view mirror

and, if driving at night
or in foggy weather,

- the exterior lights

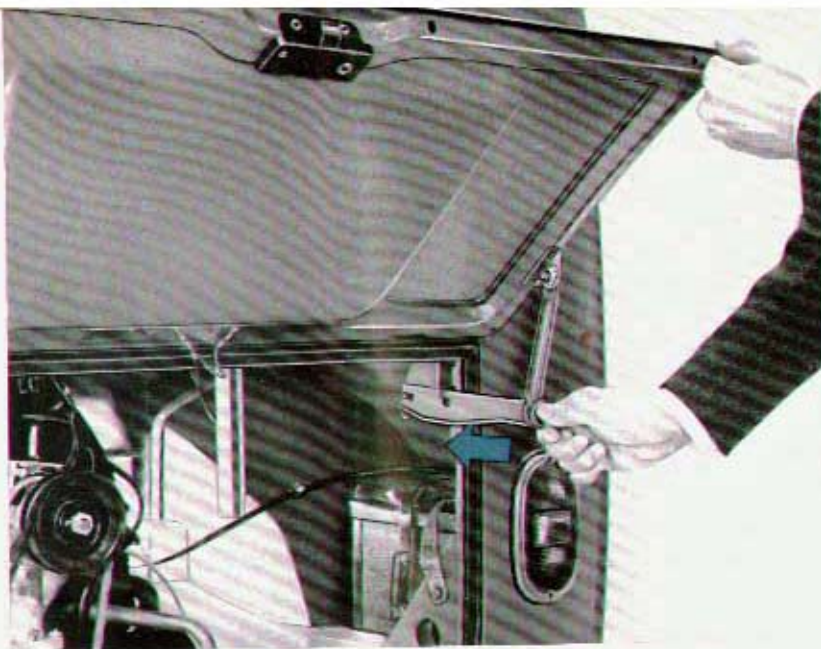

The engine compartment lid is opened with the square key which is located in a holder in the cab near the left headlamp housing. The lid can be lowered by pressing against the horizontal bar of the check mechanism.

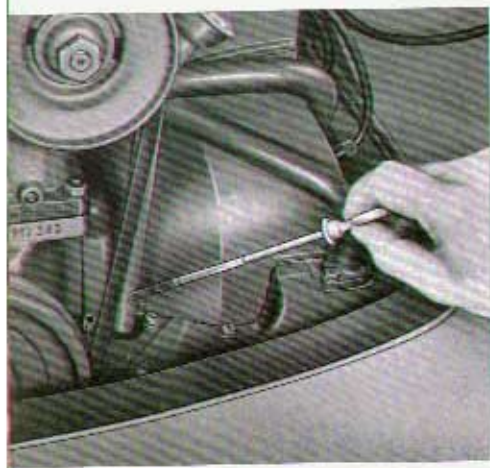

ENGINE OIL LEVEL

The oil level should be checked with the engine at rest. The oil level is satisfactory when it is between the two marks on the oil level dipstick, but **it should never be permitted to drop below the lower mark.** To make an accurate check, it is best to wipe the dipstick with a clean rag beforehand.

Should it become necessary to top up, please remember the following hints: Most oils marketed at present contain chemical ingredients to improve their lubricating qualities. However, oils of

different origin behave differently when used as engine lubricants and should, therefore, not be mixed.

Select an HD oil from the well-known and dependable brands right at the beginning, and stick to it.

Further hints regarding engine oil changes are given in the Sections "Cold Weather Hints" and "Lubrication" on pages 26 and 29—32.

FAN BELT

The V-belt drives the generator and the fan. **Perfect condition and correct tension ensures long belt life and adequate engine cooling.** Checking is very simple: when pressed with the finger, the belt must yield **approximately 15 mm. [.6"]**. If you find any sign of wear, such as frayed edges, see your VW Dealer. In spite of its long life, there should always be a spare belt on the vehicle. Details are given on page 46.

a = 15 mm. [.6"]



FUEL TANK

The tank has a capacity of 40 liters (10.6 U.S. gals., 8.8 Imp. gals), for a distance of about 400 kilometers (250 miles).

The tank filler neck on the right-hand side of the vehicle is accessible after opening the cover with the square key delivered with the vehicle.



The fuel gauge shows the amount of fuel in the tank. When the needle is on "R" (Reserve) it is time to refuel at the next opportunity. The 5 liters remaining in the tank will last for about 50 km (30 miles).

The choice of fuel type and brand is left entirely to you. The VW engine is so designed that it will run satisfactorily on all normal reputable fuels. All good brands, including gasoline-benzol mixtures, are distinguished by their consistent composition adequate anti-knock properties and freedom from harmful ingredients.

THE TIRES

deserve and require your particular attention. A special section deals with the care of the tires on pages 38—40. The riding comfort and the roadholding of your VW TRANSPORTER will greatly depend on their condition. Maintaining correct tire pressure and avoiding driving abuses are the most important factors in obtaining maximum tire life. Check regularly and keep tires inflated to the following pressures:

Front 2.0 kg./sq. cm.
(28 lbs. sq. in.)
Rear and spare wheel .. 2.3 kg./sq. cm.
(33 lbs. sq. in.)

Ambulance

Front and Rear 1.8 kg./sq. cm.
(26 lbs. sq. in.)

Do not forget to replace the valve dust caps after this inspection.



THE BRAKES

should be checked while the vehicle is in motion before starting out on a trip to make sure they are in good working order. The section "Apply the Brakes Gently" on page 17 deals with the correct application of brakes under various circumstances.

GOOD EXTERIOR LIGHTS

are the first requirement of safe car use at night. The three positions of the light switch are the following:

- 1 - Fully pushed in — Off.
- 2 - Pulled out to first stop — Parking light, tail and license plate lights.
- 3 - Fully pulled out — Headlight high or low beams (depending on position of foot dimmer switch), tail and license plate lights.

When pulling out the lighting switch knob to either the first or second stop, the instrument light is automatically turned on. By turning the knob a variable degree of instrument lighting is obtained; turning the knob to extreme left turns out the light entirely. When checking the lighting system, do not forget the two stop lights which should light up when depressing the brake pedal with the ignition turned on.

STARTING THE ENGINE

The ignition and starter are switched on, one after the other, by means of the combined starter-ignition switch. As starter operation stresses the battery heavily, other big current users, such as the headlights, windshield wiper and radio, should not be switched on when starting. Make sure, also, that the gear shift lever is in neutral.

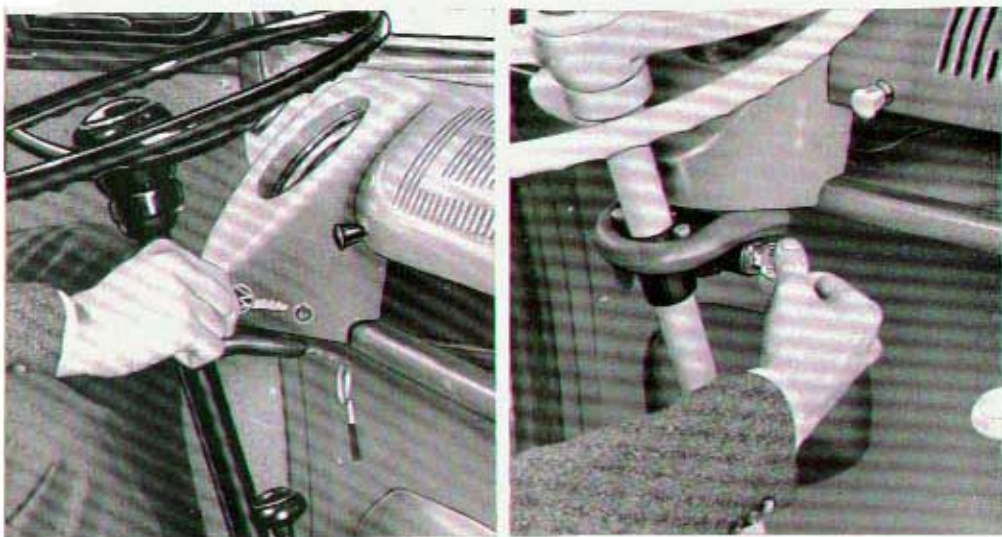

First switch on the ignition by turning the key to the right until the red and green warning lights in the speedometer come on. Then operate the starter without delay by turning the key further to the right.

At temperatures above freezing point or when the engine is still warm, depress the accelerator pedal slightly while operating the starter. Only when the engine is very warm should the accelerator be fully depressed.

At temperatures below freezing point and when the engine is cold, depress the accelerator pedal fully and then release it before switching on the ignition. This enables the automatic choke device to close the choke valve. As the engine and transmission oils tend to become thick when cold, you should also

de clutch when starting so that the starter motor only has to turn the engine. As soon as the engine starts, release the ignition key so that the starter is switched off. You can then drive off straight away as the choke valve opens automatically as the engine warms up and regulates the idling speed to suit the engine temperature. Do not race the engine when it is completely cold. If the engine does not start within the first 10 seconds, pause for about the same length of time to rest the battery before repeating the starter operation. The ignition will have to be switched off first and then on again as a non-repeat lock in the switch prevents the starter from being operated repeatedly when the ignition is on and thus being damaged by the engine when it is running. The starting procedure should not be interrupted if the engine is heard to fire a few times without starting.

If your vehicle has a steering-ignition lock, the engine is started in the same manner.

Caution

Be careful when starting the engine inside your garage. Keep the door and windows open so that the exhaust fumes can escape. These contain deadly carbon monoxide which is a colorless, tasteless and odorless gas.

MOVING OFF

is extremely easy, if you observe the following:

- 1 - Depress the clutch pedal as far as possible. Keep it in that position.**
- 2 - Shift to the first gear. Release the hand brake.**
- 3 - Engage the clutch by allowing the pedal to return slowly, and simultaneously depressing the accelerator pedal. The vehicle will start to move forward.**
- 4 - Gradually increase the pressure on the accelerator pedal and remove your foot completely from the clutch pedal, as the clutch is now fully engaged.**

Shifting to second gear is equally simple:

- 1 - Take your foot off the accelerator pedal, simultaneously depressing the clutch pedal.
- 2 - Shift gear lever into second position.
- 3 - Engage the clutch gently by gradually taking your foot off the pedal, and at the same time depressing the accelerator pedal.

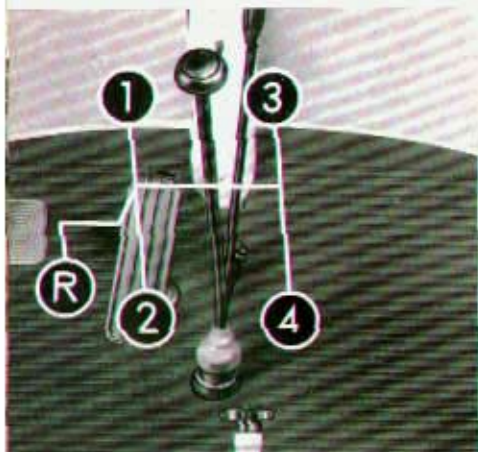

You now know how to "shift gears", and may at will shift to third and fourth positions. As you have noticed the accelerator and clutch pedals are operated simultaneously, but in opposite directions. It is the coordination of these simultaneous operations that brings skill in shifting gears.

THE REVERSE GEAR

should never be engaged unless the vehicle is at a standstill. To engage the reverse gear, first press down the gear lever vertically, move it to the left and pull it rearwards.

SHIFTING TO A LOWER GEAR

This is what you should do in dense city traffic, or with sharp turns ahead of you, or when driving up-hill.

- 1 - Release accelerator pedal and depress clutch pedal.
- 2 - Shift to 3rd, 2nd or 1st gear respectively.
- 3 - Release clutch pedal and depress accelerator pedal simultaneously.

Of course, this takes less time to do than it does to describe. We do not want to bore you with a technical discourse, but it may be of interest to you to know that, when shifting down, the synchromesh device ensures meshing of the gears without clash, as the lower gear is synchronized so that both gears are turning at the same speed.

To ensure correct synchromesh operation, it is essential that the clutch is fully disengaged when shifting gears. If the clutch pedal is only partially depressed, the gears will be difficult to engage and the synchromesh units will wear prematurely.

To avoid undue strain on transmission and engine, shifting down should only be effected within the speed range of the lower gear i. e.

from 4th into 3rd gear between 65 and 30 k. p. h. (40 and 20 m. p. h.) and

from 3rd into 2nd gear between 40 and 20 k. p. h. (25 and 12 m. p. h.)

The 1st gear is only used for moving off, driving at walking pace, or on very steep inclines.

After a short period of practice, you will take pleasure in shifting the gears properly and obtain the utmost satisfaction from the efficient performance of your new VW TRANSPORTER. Under no circumstances should you be afraid to shift to a lower gear, or even try to avoid shifting occasionally by merely "slipping" (partly disengaging) the clutch.

Do not use clutch pedal as a foot-rest while driving your vehicle.

APPLY THE BRAKES GENTLY

The brake responds to even the slightest foot pressure. Increasing the pressure will slow the vehicle down progressively. However, avoid locking the wheels. Locked wheels will not shorten the braking distance but may cause you to lose control over the movement of the vehicle and will affect the tires adversely.

Here are a few rules on braking:

Use your brakes **before**, not **while** making a turn.

It is neither practical nor economical to shift to a lower gear far ahead of a turn. Do not hesitate to use the brakes and to shift shortly before entering a curve so that you may already accelerate while still negotiating it.

To jam on the brakes suddenly can only be justified when danger is ahead. Nevertheless, it is advisable to check the full braking efficiency from time to time to familiarize yourself with the reaction of the vehicle and with the actual stopping distance. Never forget to look in the rear view mirror to make sure that you will not endanger any vehicle that might be following you. Operate your brakes especially gently when the road is wet or covered with ice as locked wheels will result in skidding.

When driving downhill, make use of the braking capacity of the engine compression by shifting to the gear which you would use in driving up-hill. You will attain a higher degree of safety and at the same time you will save and preserve the brakes if you use them only to control the speed occasionally. The ignition must never be switched off when going downhill.

STOPPING THE VEHICLE

Take your foot off the accelerator pedal and apply the brakes gently. Shortly before the vehicle comes to a full stop, depress the clutch pedal and place the gear lever in neutral. The engine continues to idle.

If you wish to turn off the engine, merely switch the ignition key to the left.

On vehicles with the steering-ignition lock, it is important to remember not to withdraw the ignition key until the vehicle is stationary as the steering is locked when the key is in the "Halt" position.

MISTED WINDOWS

will greatly reduce visibility. This is brought about by the humidity from the passengers' breath in the car and a low outside temperature. By using the vent windows intelligently sufficient fresh air can be provided while the used air is sucked out. Not only will the windows remain clear but so will your head.

THE BENCH SEAT IN THE DRIVER'S CAB

is adjustable. The back rest and cushion can be adjusted separately to three different positions.

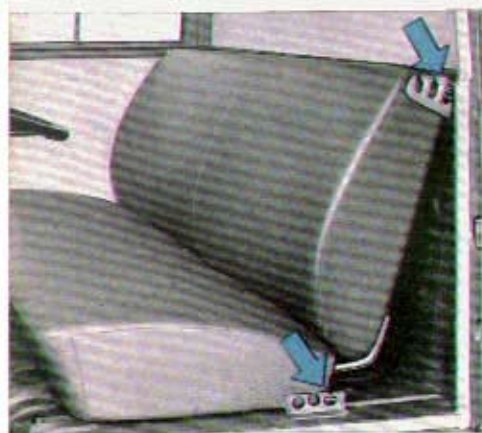

Sitting and driving for long periods places a certain amount of strain on the human body. It is, therefore, important to adjust the seat correctly to your individual requirements, and so avoid unnecessary fatigue.

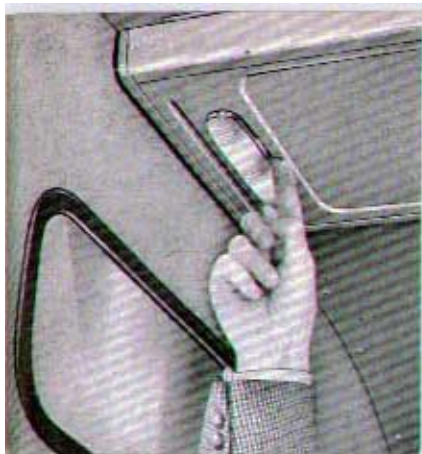

THE INTERIOR LIGHT

of the cab is operated by a switch built-in with the lamp.

The light in the loading compartment or passenger compartment is operated by the tumbler switch situated on the left-hand side of the instrument panel below the speedometer.

THE WINDSHIELD WIPERS

operate when the knob on the left of the speedometer is pulled out.

The wiper blades should be removed occasionally and cleaned thoroughly with a hard nylon brush and methylated spirits or a strong detergent solution. Particularly during long dry periods they tend to become clogged with tar splashes and insects. The blades should be renewed once a year.

VENTILATION

Of the cab and loading compartment takes place via a duct on the roof panel when the vehicle is moving. The amount of air admitted can be regulated by moving the lever on the left side of the duct to one of three positions. In the rear position the duct is closed completely.

a - Fresh air regulator lever

- 1 - On
- 2 - Off

b - Fresh air distribution

- 1 - Cab
- 2 - Loading compartment or passenger compartment

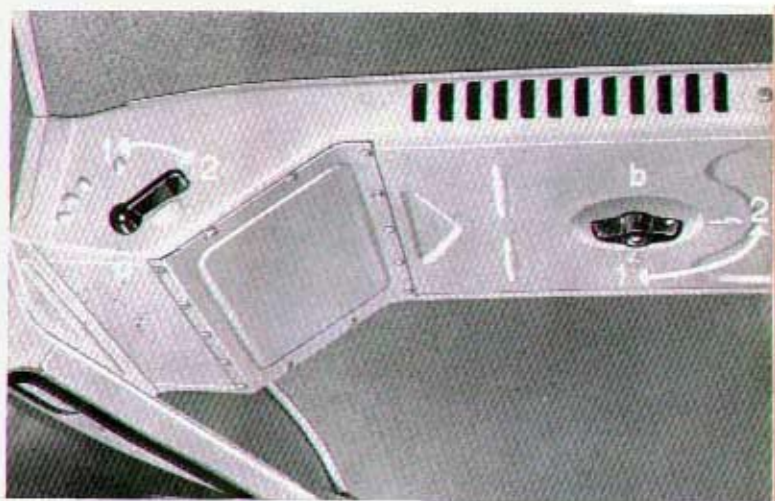

The fresh air can be distributed to cab or loading compartment by means of the lever below the duct. When set across the duct, the air is directed to the cab and when set lengthwise the loading or passenger compartment is ventilated. When the lever is set between the end positions, air is directed to both parts.

THE SUN ROOF

is free to slide when the locking lever is turned to the left. It may be fixed in any desired position by merely twisting the lever to the right. It is good practice, however, to open the roof fully prior to sliding it to the desired position. This will not only make the opened roof look better, but will also save the material by proper folding.



To close the roof, turn the lever to the left, pull roof forward until the locking hook engages in the opening and then turn lever firmly to the right.

If you have a Pick-up note the following: When the tarpaulin is wet from rain or washing, always let it dry on the vehicle to avoid shrinkage.

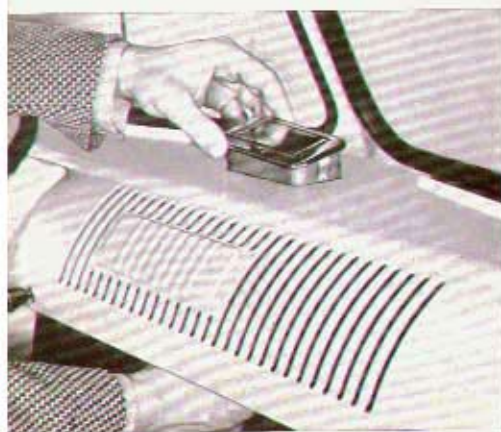

THE ASH TRAY

in the instrument panel can be easily removed by pushing it upward from below the panel.

The ash trays in the passenger compartment of the VW Micro Bus are pulled up for removal.

PRACTICAL DRIVING

BREAKING-IN INSTRUCTIONS

are not necessary for the VW Transporter. The most modern production and inspection methods have made it possible to dispense with the initial speed restrictions which are normally required. You can drive the vehicle at full speed from the first day.

It is advisable, however, to observe certain fundamental driving rules at all times. You can influence the performance and service life of your vehicle considerably by doing this.

Always keep the vehicle speed within the permissible ranges for the various gears.

1st gear	0—20 k. p. h. (0—12 m. p. h.)
2nd gear	10—40 k. p. h. (6—25 m. p. h.)
3rd gear	20—65 k. p. h. (12—40 m. p. h.)
Top gear	30—95 k. p. h. (20—59 m. p. h.)

So do not rev the engine too high in neutral nor when driving in the individual gears.

On the other hand, do not labor the engine by driving too slowly in the gears.

Always change down in good time on gradients and keep the engine at the most favorable rpm.



ECONOMICAL OPERATION

is one of the outstanding features of your vehicle. However, getting a few extra miles from each gallon depends on the manner in which you handle your vehicle and use the gears.

When accelerating.

depress the accelerator pedal slowly and only to such an extent as is necessary to reach the desired speed. Depressing the accelerator pedal rapidly does not improve acceleration, but results in an increased fuel consumption.

Do not "pump" the accelerator pedal

unless circumstances require it. Even the small quantity of fuel additionally discharged by the accelerator pump each time the accelerator pedal is depressed results in a marked increase in the overall fuel consumption.

Drive your vehicle smoothly and to suit the circumstances

both when in city traffic and on main roads. Adapt the speed of the vehicle to prevailing road and traffic conditions. A good driver accelerates gradually, slows down in time, and utilizes the braking power of the engine. Make use of the full acceleration capacity and the excellent brakes of your VW Transporter only when you really need to.

HOW TO DRIVE AT HIGH SPEED WITHOUT SACRIFICING FUEL ECONOMY

When you have accelerated to the desired speed, slowly let the accelerator pedal return to the position which just maintains this speed. This practice is especially economical when driving on highways. If you attach particular importance to economy and also to a fair average speed, you will be well advised to select a suitable cruising speed in the most efficient range of consumption.

The most economical speed in fourth gear is between 40 and 70 k. p. h. (25 and 43 m. p. h.).

The fuel consumption does not go up equally with the speed; it increases more rapidly at higher speeds. Perhaps you are aware of the fact that air resistance is an obstacle for all vehicles particularly at high speeds. Due to the simple lines of your VW TRANSPORTER, the air resistance is relatively low, but it should be remembered that high road speed always involves a greater fuel consumption.

WATCH THE ROAD

closely while driving. You should now be able to operate the various levers, switches and controls automatically. Furthermore, your TRANSPORTER will "tell" you on its own accord when it needs attention.

FLASHING INDICATORS

The direction indicators lie outside the driver's vision. However, the green indicator light shows when they are in operation.

The direction indicator switch can be operated without taking the hand off the steering wheel.

OIL PRESSURE

The oil pressure of your vehicle is as important as the oil level. When the ignition is turned on, the green oil pressure light will go on. The light should go out when the engine is started and the oil pressure increases.

IMPORTANT If the green light goes on with the engine running, the chances are that the oil circulation has been interrupted, which means that the lubrication of the engine has ceased. Stop at once and check the level of the oil before you consult a Service Station. An occasional flashing of the lamp with the engine warm and at low speed does not indicate trouble if it goes off again as the speed increases.

GENERATOR AND COOLING

are controlled simultaneously by a red light. The light will show when the ignition is turned on and when the engine is running at low speed. The light should go out as speed is increased.

WARNING If the red light goes on while you are driving the vehicle, the fan belt may be broken. Stop and find out what is wrong, for if the belt is broken, the cooling is disrupted and the generator no longer charges.

HEADLIGHTS

The high beam of your headlights can be blinding to oncoming drivers. You know yourself how unpleasant and dangerous this is. For this reason, be considerate! The blue light will tell you when the high beam is switched on. Just depress the dimmer switch to transfer the headlights from high to low beam.

Green Arrows

Green Light

Red Light

Blue Light



SPEED

You may often underestimate the speed of your VW TRANSPORTER at first. Special attention should be paid, therefore, to the speedometer during the initial driving period.

SAFETY FIRST

Safety for yourself, and safety for others, this is what counts most. Your VW TRANSPORTER is a vehicle with unequalled road holding, cornering stability and acceleration. Do not allow the feeling of security and safety which you will acquire after a few miles to make you careless.

Therefore, adjust the speed of your Transporter to the conditions of road, traffic and weather, and always be ready to bring it to a stop when it is necessary. Be particularly careful when driving on wet or icy roads, for even a VW TRANSPORTER is apt to skid when not driven carefully under such conditions.

THE REAR VIEW MIRROR

can be adjusted from the driver's seat to suit individual requirements. Set it in such a manner as to be able to observe the entire width of the road behind the vehicle for a great distance without turning the head or the upper part of the body.

PASSING OTHER VEHICLES

Pass other vehicles with consideration. Always be sure that the road is clear ahead of you, and look out for vehicles approaching you from the opposite direction. A brief look in your rear view mirror will tell you whether another vehicle is about to pass you from behind. If you have to shift to a lower gear, do it before, not while, passing other vehicles.

And here is another warning: Never try to overtake when approaching a curve, where vision is not clear, and never overtake at the crest of a hill or at cross-roads. You never can tell what lies ahead of you.

Be fair and do not accelerate when another car tries to pass you. You will endanger your life and others.

STOPPING YOUR TRANSPORTER TEMPORARILY

When stopped at an obstruction, a traffic light or railroad crossing, do not wait with the clutch pedal pressed down and the gear engaged. Shift to first gear shortly before moving on again, it will preserve the clutch.

PARKING YOUR TRANSPORTER

in a space between two vehicles parked at the curb can be easier if you heed the following advice:

Stop your vehicle level with the vehicle in front of the space. Turn the steering wheel sharply to the right and back your vehicle slowly into the gap.



When the front bumper of your Transporter is even with the rear bumper of the vehicle ahead of you, turn the steering wheel fully to the left, and back up further toward the curb.



Now turn the steering wheel to the right again and pull up a little bit, until both ends of the vehicle come as close to the curb as possible.



When parking on a steep gradient set the hand brake to stop the vehicle rolling. As a precautionary measure, it is advisable to engage first or reverse gear in addition to the hand brake. And do not forget to take the key out of the ignition switch before you leave your vehicle. If a steering-ignition lock is fitted, remove the key at the "Halt" position. This locks the steering and protects the vehicle against theft.

Prior to locking the driver's door secure the door on the other side by lowering the inside door handle.

It is advisable to lock the door windows when leaving the vehicle for any length of time.

COLD WEATHER HINTS

IN WINTER

your VW TRANSPORTER has two features which you will really appreciate:

AIR COOLING AND HEATING

You may expose your vehicle to bitter cold without fear: — its air-cooled engine will always be ready to start. You will drive in warm comfort, well protected from drafts and from sleet and snow, while a current of warm air will keep your windshield free from condensation and frost, permitting you a clear view.

The increased stress that your vehicle has to stand in winter because of frost and dampness can be easily dealt with if you observe the recommendations presented in this section.

THE WARM AIR HEATING

can be regulated by a rotary knob situated at the right-hand side under the seat:

- Anti-clockwise — On (1)
- Clockwise — Off (2)

Warm air to the defroster nozzles and to the feet is further controlled by the distributor in front of the hand brake lever. Heating efficiency can be considerably increased by opening a vent window so that the blower can force the warm air more easily into the otherwise well sealed interior.



ENGINE OIL

SAE 20 W/20 oil will not thicken at temperatures above 0 °C (32 °F) and will permit easy starting of the engine. If, however, atmospheric temperatures below freezing point are anticipated the use of SAE 10 W is recommended. This grade of oil may remain in the engine with safety when the temperature again rises to a higher range. Should it become necessary to add oil in the period between two regular oil changes, SAE 10 W oil may be used during lasting frost and SAE 20 oil when the average temperature rises. This means that the grades SAE 10 W and SAE 20 W/20 can be mixed without detriment, but be sure to use always the same brand and type of engine oil.

The engine does not need to be warmed up before moving off, but it is advisable not to race the engine immediately after starting when the temperature is low.

Only if your VW Transporter is mainly operated for short distances **during cold weather** is it advisable to have the oil changed at more frequent intervals, say every 2500 km. (1500 miles), using the prescribed HD oil. In the warmer season, oil changes in addition to those laid down in the Lubrication Chart are unnecessary and uneconomical.

In territories where exceptionally low temperatures prevail (—25 °C / —13 °F), the use of SAE 5 W is recommended: this should be changed every 1250 km. (750 miles). The oil strainer should be cleaned at the same time.

TRANSMISSION OIL

The SAE 90 oil need only be replaced by oil of another grade in winter when it is anticipated that the temperature will be below —10 °C (14 °F) for a prolonged period. When this is the case, the thinner SAE 80 oil should be used temporarily as it facilitates gear shifting when the transmission is cold.

THE CHASSIS

is particularly exposed to the cold and wet weather in winter. You are therefore strongly advised to adhere strictly to our instructions for lubrication. If, in addition, you spray the bottom of the vehicle with a special chassis oil, as a protection against rusting, you will prolong the life of your VW Transporter.

THE BRAKES

of all automobiles are more or less exposed to splashing water which in winter is apt to freeze in the brake drums. Therefore, when parking your vehicle, do not set the hand brake but shift to first or to reverse gear. At the beginning of the cold season, the conduit tubes of the brake cables should be thoroughly lubricated with anti-freeze lubrication grease. Do not use just any car-lubricant, but get the right one at any VW Dealer.

THE DOOR LOCKS

can freeze up in the winter, especially if water gets into the lock cylinder when washing the vehicle. You should, therefore, not aim the water jet directly at the lock, or better still, cover the key hole up when washing. A frozen lock can be opened by warming the key before insertion and then squirting anti-freeze into the lock cylinder straight away.

TIRES

Worn tires are apt to cause trouble in winter. For safety's sake replace them in time. To meet the special requirements in winter, so-called **M + S** tires are available. These special-tread tires are designed to give a better grip on mud and snow. They are either used on the rear wheels only or on all four wheels. However, during the rest of the year you should use the usual tires.

CHAINS

You will need chains only when the roads are covered with snow. Without such chains the rear wheels of your vehicle are apt to spin, and applying the brakes may result in skidding. Have the chains adjusted to the wheels if you wish to avoid loss of time and inconveniences later on. When driving on long stretches that are free from snow, the chains should be removed to avoid unnecessary wear of both chains and tires.

THE BATTERY

is under greater strain in winter than in warmer seasons because of the increased consumption of current when starting the engine and using the lights at night. Besides this it is a characteristic feature of any battery that its efficiency decreases at lower temperatures. If the vehicle is used mostly over short distances, the battery may require additional recharging.

Therefore, have your battery checked regularly and you will never have starting difficulties.

SPARK PLUGS

The normal gap is 0.7 mm. (.028"). In extremely cold weather reduction of the gaps to 0.4—0.5 mm. (.016"—.020") will aid cold starting considerably.

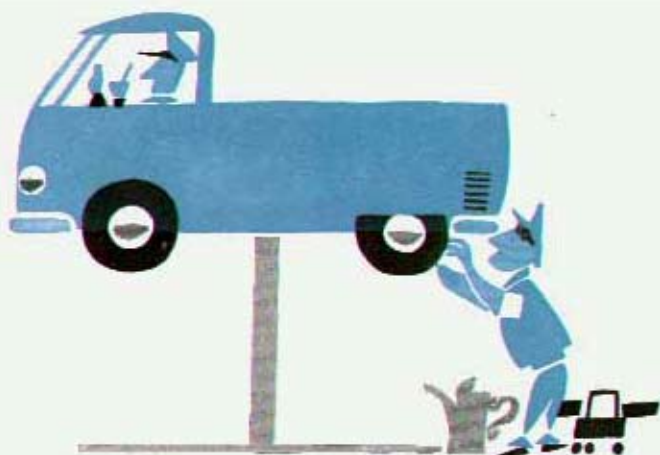

LUBRICATION

PROPER LUBRICATION IS OF VITAL IMPORTANCE TO YOUR VW TRANSPORTER

The extra time spent in following these recommendations will be amply rewarded in the long run by your vehicle's efficient performance. It is up to you to maintain the standard of safety offered by your VW TRANSPORTER, and to insure the long life and good service which you have the right to expect from this truly economical vehicle.

TO LUBRICATE CORRECTLY MEANS TO LUBRICATE CAREFULLY AND AT THE PRESCRIBED INTERVALS

Therefore, do not shy at the work connected with regular lubrication. A Lubrication Chart can be found on page 75, indicating the correct mileages at which to lubricate. The Service Booklet makes it possible for you to have your Volkswagen lubricated in an authorized workshop by skilled hands, at lowest cost and in a minimum of time. You really cannot afford to miss this opportunity.

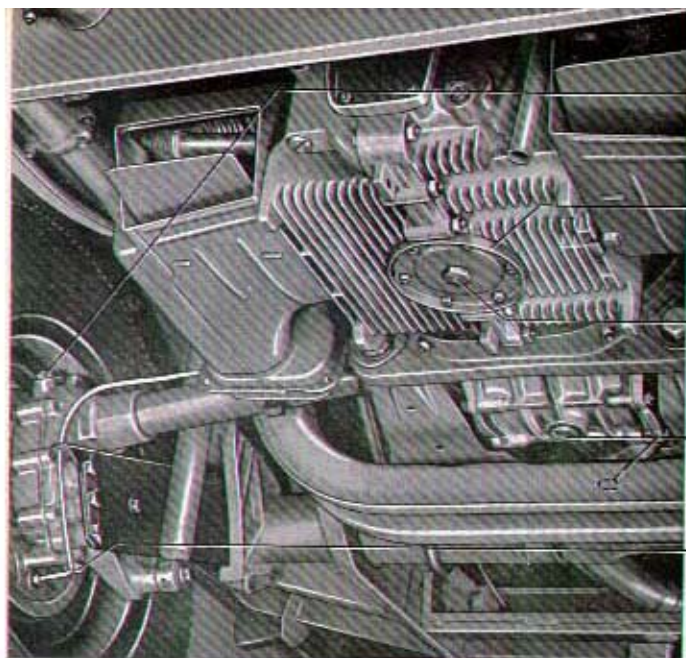

Oil Filler Plug

Oil Strainer
with cover

Oil Drain Plug
for crankcase

**Magnetic Oil
Drain Plugs**
for rear axle and
transmission

Oil Drain Plug
for reduction gears
at rear wheels

ENGINE OIL CHANGE

Regular oil changes are necessary even if the very best branded oils are used. Diluted and dirty oil in your engine simply means a greater strain and a shorter life for your engine. On the other hand, provided that HD oil is used, it is unnecessary and uneconomical to change the oil more frequently than called for in the Lubrication Chart.

The old oil is drained when warm by removing the drain plug in the oil strainer cover. The plug is then screwed in again and tightened properly.

The engine is refilled with
2 1/2 liters of HD oil
(5.3 U.S. pints,
4.4 Imp. pints)

Flushing of the engine
unnecessary.





- 1 - Gasket
- 2 - Oil strainer
- 3 - Gasket
- 4 - Bottom plate
- 5 - Oil drain plug and seal
- 6 - Nut and spring washer

THE OIL STRAINER

retains foreign matter and should be taken out and cleaned at every oil change. The two gaskets should be renewed each time the strainer is removed.

TYPES OF LUBRICANT

The advantages of using a

branded HD oil

are quite evident.

HD oils have proved oxidation stability, bearing corrosion preventive properties and detergent-dispersant characteristics which tend to hold in suspension foreign contaminants which would normally settle on engine parts. These foreign contaminants will drain out with the oil at the periodical oil changes. The detergent properties of HD oil will make the fresh oil darker after a short period of use. This is quite natural and there is no reason whatsoever to change the oil earlier than called for in the Lubrication Chart.

SOME MORE INFORMATION ON ENGINE OILS

It is left to your discretion to select an oil from well-known and dependable brands of the proper viscosity to suit your seasonal and driving requirements. In cases of doubt, refer to your authorized VW Dealer who will be glad to help you with your lubrication problems. It is recommended that you select "your" oil right at the beginning and stick to it at all future service oil changes.

The requirements of the VW engine are met by all approved commercial brand oils. Viscosity of the lubricant is an indication of its resistance to flow at a given temperature. The SAE numbers classify lubricants in terms of viscosity, for example: SAE 20 W/20, SAE 10 W etc. Outside air temperature is decisive for the selection of the SAE grade to be used.

SAE 30 This oil is satisfactory in tropical climates where the temperature range will frequently rise above 30° C (86° F).

SAE 20 W/20 engine oil is recommended for use within the temperature range from 30° C to 0° C (86° F to 32° F). It may also be used with safety in temperatures temporarily outside these limits.

SAE 10 W engine oil is recommended for use if the temperature is anticipated to fall below 0° C (32° F). It may also be used with safety should temperatures rise above freezing point. A change of oil is, therefore, not necessary until the next regular mileage interval.

SAE 5 W This oil is for use in arctic climate (below — 25° C / — 13° F) only (in place of SAE 10 W).

In some countries the API Classification is applied (API = American Petroleum Institute). According to this classification, the HD oils suitable for the VW Engine are referred to as "For Service MS". For further details see page 27.

MULTIGRADE OILS

are HD oils which cover several viscosity grades, such as SAE 10 W/30 for example. These oils are also suitable for VW engines.

ADDITIVES

should not be mixed with HD oils.

IGNITION DISTRIBUTOR

The amount of grease at the breaker arm fiber block should be checked and, if necessary, replenished at the specified intervals.

Every 5,000 km. (3,000 miles), apply 1 drop of oil to the felt ring in the contact breaker base plate.

TRANSMISSION AND DIFFERENTIAL

The transmission and differential gears are combined in the transmission case and both lubricated with the same hypoid oil. Timely oil changes have a beneficial affect on the smooth running of the gear trains. The old oil is drained by removing both the magnetic drain plugs while the oil is at operating temperature.

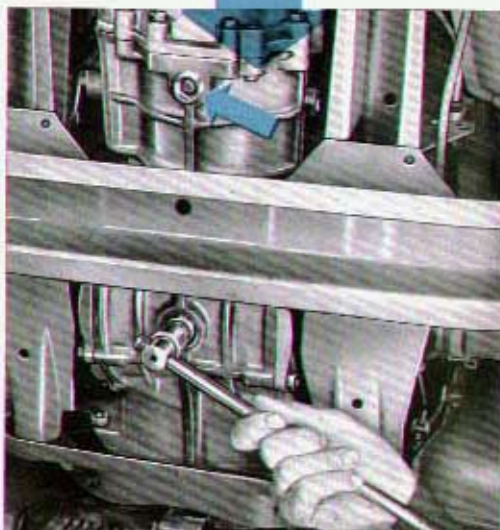

Then refill with **2.5 liters of hypoid oil (5.3 U.S. pints, 4.4 Imp. pints).**

The magnetic drain plugs should be thoroughly cleaned at 500, 2,500, 5,000 kilometers (300, 1,500, 3,000 miles) and then at every transmission oil change. As the plugs can only retain a limited amount of deposits, the intervals for cleaning should be strictly adhered to particularly during the gear running-in period. At 2,500 and 5,000 kilometers the plugs should be removed one at a time and the holes blocked temporarily with a wooden plug. The oil level should then be checked and oil added if necessary. The oil should be about 5 mm below the edge of the filler hole.

No additives should be used with hypoid oil nor should hypoid oils of various brands be mixed.



REDUCTION GEAR

Each reduction gear case should be refilled with **0.25 liters of transmission oil (0.53 U.S. pint, 0.44 Imp. pint)** at the same intervals as the transmission case.



STEERING GEAR

The steering assembly should be lubricated exclusively with SAE 90 hypoid oil, and under no circumstances with grease or any other oil. The level of the oil in the steering case should be kept at the lower edge of the filler plug hole.

CHASSIS

Proper lubrication of the front axle bearing points is best done by raising the front axle so that the weight is taken off the wheels.

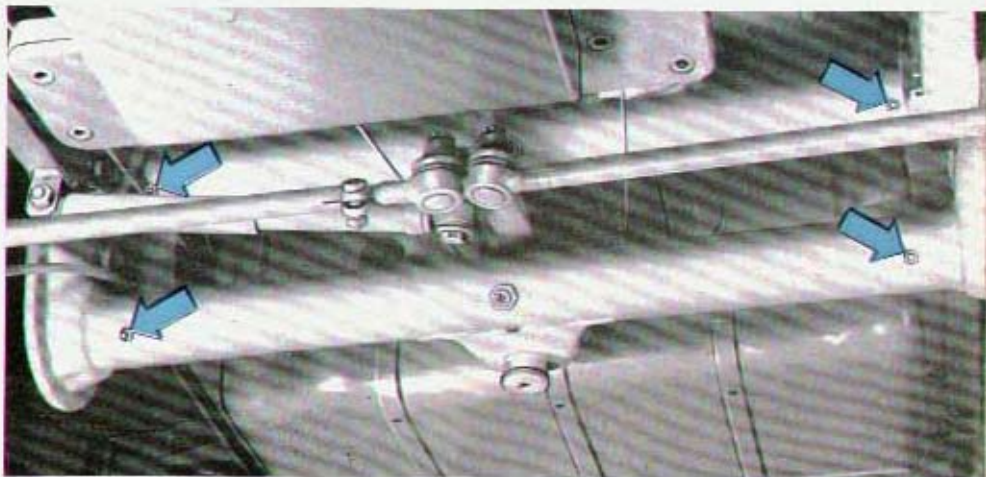

Prior to lubrication, the grease fittings should be cleaned thoroughly with a clean piece of cloth, so as to avoid any dirt or foreign matter from entering the

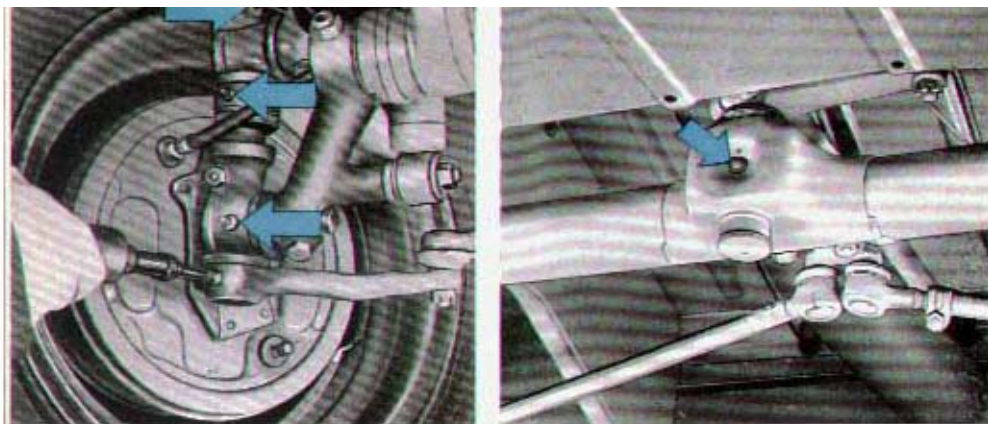

fittings. The tip of the grease gun should be pressed on to the fitting, and then grease should be injected until the grease begins to emerge at the edges of the lubrication point.

The number and the location of the lubrication points of the chassis can be seen in the Lubrication Chart and the corresponding illustration.

Not even the smallest quantity of grease should come into contact with the tires and brake hoses. If it does these parts must be cleaned thoroughly.

If the vehicle is driven mainly over rough roads, it is advisable to lubricate king pins and torsion arm link pins at more frequent intervals, say every 1,250 km. (750 miles).

Annually, at the beginning of the cold season, the cables and conduit tubes of accelerator and heating should be cleaned and greased.

The clutch cable adjusting nut should be greased whenever necessary, but in any case, once a year at the beginning of the cold season.

THE FRONT WHEEL BEARINGS

are sufficiently provided with grease at the factory. The caps on the front wheel hubs must be free from grease.

According to the maintenance chart the front wheel bearings are to be cleaned and repacked with grease as specified under the heading "Lubricants" every

50,000 km. (30,000 miles). The brake drums must be removed for this purpose. Finally the front wheel bearings must be adjusted. In order to avoid damage to the bearings this operation should, if possible, be carried out by a VW Dealer.

DOORS AND LOCKS

The door lock striker plates should be very lightly greased. Apply a few drops of oil to the lid hinges. The door hinges should be oiled at every lubrication service or, better, once a week after dust and dirt have been removed.

Door cylinder locks should be treated with graphite. Blow a small quantity of powdered graphite through the key hole. Dip the key into the graphite, insert key and move it back and forth several times.

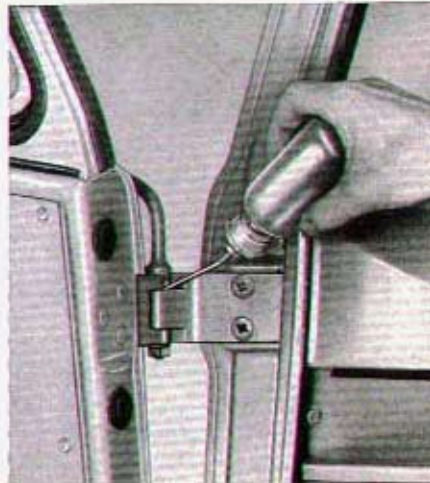



WHEELS AND TIRES

The importance of proper tire pressure has already been explained on page 12. Here are a few hints.

Bad driving habits also lead to premature tire wear. High speed driving and cornering, skidding to a stop and striking curbs or objects on the road wear tires more than many miles of careful driving.

Tire life is also considerably shortened by incorrect front wheel alignment or lack of balance of the tire and wheel assemblies. The tire tread should never be allowed to wear down to a thickness of less than 1 mm. (.04") which is the absolute minimum required for safe usage.

A drop of oil applied to the wheel mounting bolts will facilitate the next tire change.

Avoid overloading the vehicle and protect the tires from intense sunlight, fuel, or oil. Normal wear may be kept at a minimum by rotating wheels and tires including the spare at approximately 5,000 km. (3,000 miles) intervals. Take the opportunity to check the tires for foreign matter and outer damage. Rotate wheels as indicated below.

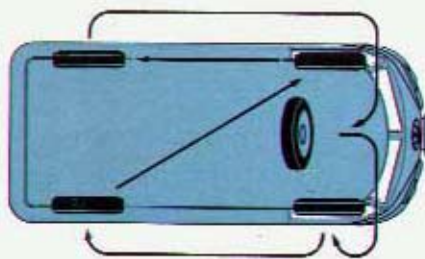

The spare wheel is accommodated behind the driver's seat back. It is accessible after removing the back. Underneath the cab seat you will find the jack and tool kit required for changing tires.

For smooth running at high speeds and to obtain a long life, it is important to have the wheels balanced statically and dynamically when tubes or tires have been repaired. As, after long running periods the wheels can be out of balance owing to natural wear of the tires, they should be balanced statically and dynamically every 10,000 km. (6,000 miles).



When the tires are being mounted, the red mark on the sidewall should be lined up with the valve to ensure better balancing of tube and tire.

CHANGING WHEELS

Changing a tire on the road is certainly not pleasant. However, it will be easier after you have read these few lines which tell you the correct way.



- 1 - Set the handbrake securely and block the wheel opposite the one to be removed to prevent the vehicle from shifting off the jack.
- 2 - Insert jack into the square tube below the body.
- 3 - Remove hub cap with hub cap removal tool.
- 4 - Loosen wheel bolts with the socket wrench before wheel is fully jacked up.
- 5 - Raise vehicle until tire clears ground.

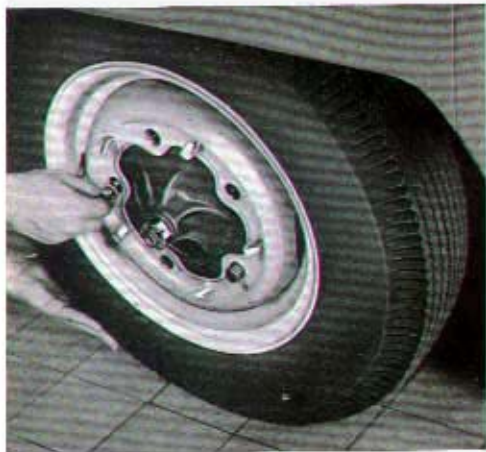

- 6 - Remove wheel bolts and take off wheel.
- 7 - When reinstalling the wheel, operate the jack until the five holes in the wheel are nearly lined up with the holes in the brake drum.
- 8 - First, insert one wheel bolt only. Tighten it enough to allow the wheel to be swung around this point by hand, until the remaining holes in the wheel and brake drum coincide.
- 9 - Insert and tighten the remaining bolts until the countersunk heads of the five bolts are centered in the corresponding recesses of the wheel.
- 10 - Tighten all bolts diametrically opposite in turn.

- 11 - Lower the vehicle, remove jack and make sure that all bolts are tight.
- 12 - Install hub cap firmly and make sure that it is tightly seated.



CARE OF THE VW TRANSPORTER

CLEAN AND NEAT APPEARANCE

To keep the VW TRANSPORTER looking smart and new is a matter of pride to the driver or owner of the vehicle. Regular and efficient care will protect not only the outer appearance of the vehicle but also the body and the chassis.

WASHING YOUR VEHICLE

Wash your new VW Transporter frequently during the first weeks as this is good for the finish. For washing you require a soft sponge for the body, a soft brush for the wheels, a sturdy, long-handled brush for the chassis and plenty of clear water. For drying you need a chamois.

The chassis and lower part of the body should first be flushed with water, to soak off the dirt, and afterwards a brush should be used.

Spray the exterior finish of body and wheels with water until dirt is soaked off. Do not allow powerful jet of water to hit the painted surface. Using plenty of clear water, remove dirt with a sponge. Care should be taken to clean the sponge at short intervals to avoid scratching the polished parts. There are some approved auto soaps and detergents which greatly facilitate this job. Avoid the use of any product which has not been recommended by your VW Dealer. It is of utmost importance to wash the body thoroughly with water after the car-wash has been applied to ensure that no traces of it remain on the body.

After washing, dry off with a clean chamois to prevent water spots.

PRESERVATION (WAXING)

means to restore to the finish certain substances it has lost by exposure to the weather. As these substances are vitally important to the elasticity of the finish, it is necessary to apply a protective water-repellent coat of wax to the body. The intensive cleaning effect of the shampoo removes this protective coating so that it should be renewed accordingly.

A preservative specially produced for the finish of your VW TRANSPORTER can be obtained under the designation "L 190" from your VW Dealer. The body should be waxed after the first eight or ten weeks and then regularly at intervals of from six to eight weeks — in any case after each soap or detergent washing, as already mentioned. Applying the preservative is quite easy: With a soft cloth, spread a thin film on the finish, then rub it down when dry (after about 20 minutes), using polishing cotton or a soft polishing cloth, until iridescent colors can no longer be seen when standing at an angle to the polished area. Of course, the vehicle must be washed and dried carefully prior to applying the preservative.

POLISHING

You should polish your VW Transporter only if its appearance has been strongly affected by road dust, sunlight and rain in consequence of insufficient care and if the application of the preservative no longer restores the original lustre. Avoid the use of abrasives or chemically harmful products, even if their first application seems to give satisfactory results. A special polish for treating the synthetic-resin finish is also obtainable from your VW Dealer under the designation "L 170". Prior to applying the polish, the car must be washed and dried carefully. Dust or dirt should never be wiped off dry. The polish should be applied with polishing cotton — use a straight horizontal or vertical motion rather than a circular motion. After some rubbing you will feel a slight resistance, which indicates that the ingredients of the polish have settled in the finish and that the solvent has evaporated. Now take clean polishing cotton and rub the body down until the high gloss is restored.

Do not apply the polish on too large an area of the body at a time.

A subsequent application of preservative gives you care-free pride in your car for a long time.

Never wash, wax or polish the vehicle in sunlight.

HOW TO REMOVE SPOTS

Water alone will not always remove splashes of tar, oil traces, "baked on" insects, etc. On principle, such foreign matter should be removed as soon as possible, for if you neglect this, permanent damage to the finish may be the result.

TAR SPOTS. An unpleasant sight, to be noticed particularly on light-colored vehicles, are tiny tar spots which show up on hot days when driving on newly tarred roads. Tar splashes have a tendency to corrode the finish within a short time and should be removed immediately after discovery. On the road, you usually will have nothing at your disposal but fuel, which may be applied with a soft cloth. Kerosene or turpentine oil may also be used. After this, the treated spots should be washed with a mild, lukewarm soap solution and rinsed, in order to remove traces of the cleansing agent. It is, however, better to use our preservative already mentioned, which renders the treatment with soap solution unnecessary.

INSECTS are caught especially during the night, in hot weather, by the front end of the vehicle. Once baked on they are very difficult to remove with water and sponge, but should be treated with lukewarm soap solution.

TREES IN BLOOM especially lime trees in many instances drop tiny quantities of liquid. Cars that have been parked underneath such trees become "freckled" all over. These stains, too, can be readily removed with soap solution if the necessary steps are taken in time. After-treatment of the cleaned spots with the preservative is strongly recommended.

CLEANING SUN ROOF

The plastic cover of the sun roof requires no special care. It should be cleaned with a weak, lukewarm solution of a pure soap (soap flakes) and then washed down thoroughly with clean water. Spots should never be removed with aromatics such as paint thinners or chlorine containing spot removers as these will attack the plastic. Stains should be removed with a cloth dampened with benzine followed by a wash with soapy water and a final rinse with clean water. Be sure the cover is thoroughly dry before opening the sun roof.

CHROMIUM-PLATED PARTS should be lightly coated with chromium wax, such as "Chromlin". It is not recommended to use grease, as this will collect dust and dirt.

CARE OF THE UPHOLSTERY. Cleaning of leatherette upholstery with a soft cloth or soft brush is recommended. Special care should also be taken to remove dust and dirt from the seams. Better results can be obtained using a soft whisk

broom and suds of any mild soap (castile or olive oil base) in lukewarm water (rain, boiled or soft water). Use the water sparingly, as the upholstery otherwise requires a long time to dry, if water trickles through the stitches. Grease and paint spots should be wiped off before they dry up. Soaked-in spots can be removed by carefully using a rag moistened with gasoline or alcohol. Spots caused by shoe polish can be removed by means of turpentine. Use these agents carefully and sparingly as otherwise, they would tend to dissolve the dust-repellent finish of the leatherette. Solvents such as trichloroethylene or paint thinner should not be used. After the cleaning operation, use a soft clean cloth to polish the surface of the leather. Carefully treat the upholstery seams. Never use furniture polishes, oils, varnishes or cleaners on imitation leather upholsteries. They will injure the finish.

CLEANING GLASS. Windows can be cleaned by washing with warm water and wiping dry with a clean, soft linen cloth. To facilitate this task on the windshield, the arms of the windshield wipers may be tilted forward. To clean exceptionally dirty windows, use alcohol or household ammonia and lukewarm water.



MAINTENANCE

The VOLKSWAGEN SERVICE ORGANIZATION has made available for you an extensive network of Authorized VW Dealers, staffed with well trained and experienced men, and equipped with all the required special tools and appliances to service your vehicle. If ever you should need service when touring, or away from home, look for the well-known VW Service Sign. The workshop displaying this sign is your assurance of the same expert, prompt, and courteous service you are accustomed to receive at home.

In case you can't get to an Authorized VW Dealer in time, we are giving you some information which, if needed, will help you to carry out normal maintenance work. However, repair jobs which are beyond your capacity should be performed by the nearest VW Dealer. There your VW Transporter will be given expert treatment by those familiar with its construction.

This will save you time, inconvenience and money.

SERVICING THE AIR CLEANER

The air cleaner filters particles of dirt and grit from the air used for combustion. Regular attention should be given to the maintenance. A dirty air cleaner reduces the performance of the engine and increases fuel consumption.

The **Oil Bath Air Cleaner** should be cleaned every 5000 km. (3000 miles). Remove lower portion from the intake elbow. Remove dirty oil from oil reservoir and refill with SAE 20 engine oil up to the mark.



The filter element should be rinsed in fuel, kerosene, or any other degreasing solution and then dried.

If the vehicle is operating mainly in heavily dust-laden atmospheres, it is up to you to prevent premature wear by servicing the air cleaner more frequently than specified above. The air cleaner must, in any event, always be cleaned if there is no thin oil above the sludge at the bottom of the oil reservoir.



ADJUSTING OR REPLACING THE FAN BELT

To adjust or replace the fan belt, remove nut and outer half of generator pulley. When loosening or tightening nut, insert a screwdriver in the slot in the inner half of the pulley and support it against the upper generator housing bolt. The adjustment of the fan belt tension is effected by means of spacer washers situated between the two pulley halves. Belt slackness is taken up by removing one or more washers. If the belt is too taut, one or more washers should be added.

The fan belt should not be too slack, nor should it be too tight. Newly installed belts will stretch to some extent and should, therefore, be checked and adjusted after 500 kilometers (300 miles).

Always keep a new fan belt handy.

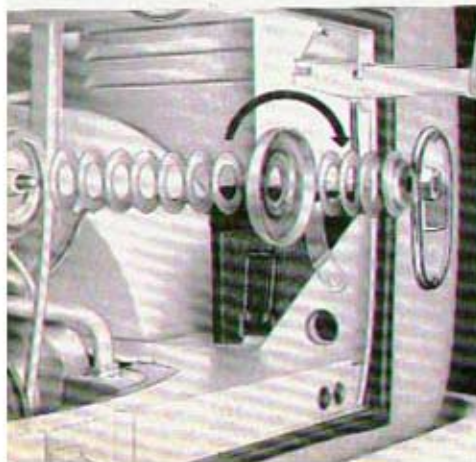

CHECK AUTOMATIC AIR INTAKE CONTROL

Incorrect adjustment of the throttle ring is responsible for the engine attaining its operating temperature too slowly or overheating. If the throttle ring opens too far, it may foul the fan resulting in considerable noise.

The automatic air intake control is correctly adjusted if

- 1 - the throttle ring rests slightly pre-loaded against the air intake flange when the engine is cold.
- 2 - with the engine warm, the distance from the top edge of the air intake flange to the edge of the throttle ring measures 25—30 mm. (1 to 1.2 in.) when the upper end of the thermostat in the right lower heater channel touches the stop of the support.



CHECK ADJUSTMENT

- 1 - Warm up the engine until the upper end of the thermostat touches the stop of the support.
- 2 - Unhook throttle ring return spring.
- 3 - Loosen throttle ring operating lever.
- 4 - Adjust throttle ring so that it opens 25 mm. (1").
- 5 - Tighten operating lever and insert return spring.
- 6 - Check automatic air intake control for proper functioning.



CLEANING THE FUEL FILTER

The fuel pump filter prevents foreign matter and dirt from entering the carburetor.

The filter should be cleaned at the proscribed intervals.

- 1 - Remove retaining screw with an open end 8 mm. wrench and take off cover.
- 2 - Take out filter and wash out in benzina.
- 3 - Dry filter thoroughly and install it. The reinforcement ribs should be at the top.
- 4 - Insert cover and install screw with gasket.

CARBURETOR ADJUSTMENT

The carburetor is tested at the factory and properly adjusted to the engine. Do not alter this adjustment by exchanging the jets for other than the proscribed sizes. This would be detrimental under normal operating conditions, and many result in hard starting, excessive fuel consumption or unsatisfactory engine performance.

Only the idling adjustment may call for occasional regulation. Before attempting to adjust the carburetor, make sure the engine is at normal operating temperature.

Also check that the idle adjustment screw is on the lowest step of the fast idle cam.



The filter element should be rinsed in fuel, kerosene, or any other degreasing solution and then dried.

If the vehicle is operating mainly in heavily dust-laden atmospheres, it is up to you to prevent premature wear by servicing the air cleaner more frequently than specified above. The air cleaner must, in any event, always be cleaned if there is no thin oil above the sludge at the bottom of the oil reservoir.



ADJUSTING OR REPLACING THE FAN BELT

To adjust or replace the fan belt, remove nut and outer half of generator pulley. When loosening or tightening nut, insert a screwdriver in the slot in the inner half of the pulley and support it against the upper generator housing bolt. The adjustment of the fan belt tension is effected by means of spacer washers situated between the two pulley halves. Belt slackness is taken up by removing one or more washers. If the belt is too taut, one or more washers should be added.

The fan belt should not be too slack, nor should it be too tight. Newly installed belts will stretch to some extent and should, therefore, be checked and adjusted after 500 kilometers (300 miles).

Always keep a new fan belt handy.

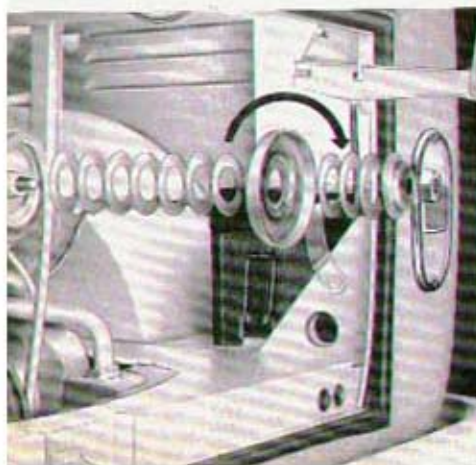

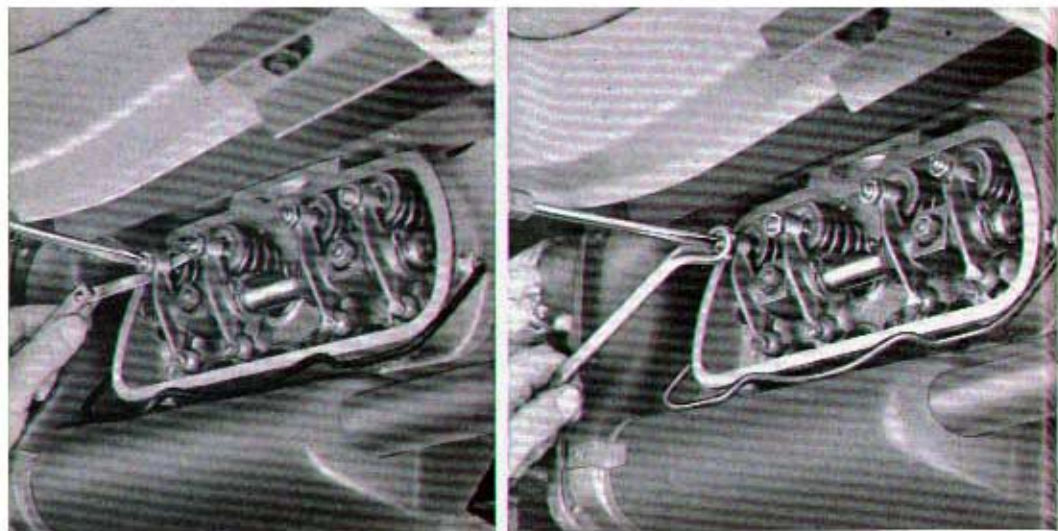

Remove cylinder head cover.

Valve clearance should be 0.20 mm. (0.008") for the intake and exhaust valves with the engine cold.

Adjust valve clearance only when the engine is cold.

The arrangement of the cylinders may be seen from the numbers 1 to 4 marked on the end plates.

Valve adjustment may be made in the following sequence: No. 1 — No. 2 — No. 3 — No. 4 cylinder. Adjust the valves when the piston of the corresponding cylinder is in top dead center position of the compression stroke as both valves are then closed.

Starting with No. 1 cylinder, crank the engine over slowly anti-clockwise by the fan pulley, until both valves are in fully closed position and the timing mark on the pulley is in line with the vertical crankcase joint.

Loosen the adjusting screw lock nuts. After adjusting the valve clearance with the feeler gauge to 0.20 mm. (0.008") tighten the lock nut and check the clearance.

Check and adjust the other valves to the proper clearance in this manner by turning the crankshaft anti-clockwise another 180° for each cylinder.



a -- 0.7 mm.
.028"

CHECKING THE SPARK PLUGS

Remove the spark plugs and check their exterior. The appearance of electrodes and insulators provides considerably information on engine adjustment and condition.

Electrodes and insulator

- medium grey — good adjustment of carburetor and correct performance of spark plug,
- black — mixture too rich,
- light grey — mixture too lean,
- oiled up — misfiring or piston ring blow-by.

Clean the spark plugs with a brush and a chip of wood and blow them out. The insulator should be clean and dry on the outside in order to avoid short circuits or tracking. Check the electrode gap (0.7 mm. = .028") and reset if necessary by bending the outer electrode. Use a proper gasket when installing the plug. Generally speaking you may count on a service life of the spark plugs of up to 15 000 km. (9300 miles).



CHECK COMPRESSION

After warming up the engine, remove all 4 spark plugs. Operate the starter motor with the accelerator pedal fully depressed and the throttle wideopen. The compression is checked by inserting an accurate compression gauge into the spark plug hole of each cylinder.

Result: good	7.0—9.0 kg./sq. cm. (100—128 lbs./sq. in.)
satisfactory	4.5—7.0 kg./sq. cm. (65—100 lbs./sq. in.)
poor below	4.5 kg./sq. cm. (65 lbs./sq. in.)

IGNITION AND TIMING

Particular attention should be paid to correct ignition timing. The operation of the engine will be seriously affected if the ignition breaker points are not properly timed and correctly spaced. In many cases poor performance, high fuel consumption and even severe damage to the engine can be the result of incorrect ignition setting. The ignition must not be advanced arbitrarily, not even when using premium grade fuels.

Adjust the ignition **with the engine cold.**



Adjusting Contact Points

Remove distributor cap and rotor. The breaker contact points are adjusted by cranking the engine until the fiber block on the contact arm rests on the highest point of the cam lobe. Then loosen the stationary point locking screw, and insert a screwdriver between the two small lugs on the contact plate and the slot in the fixed point arm. Turn the screwdriver to adjust the gap to the correct clearance of 0.4 mm. (0.016"). Tighten the stationary point locking screw. If the points are burned, rough or pitted, clean them with a contact file or, better still, replace them. The distributor cap should be clean and dry, inside and out, so as to avoid short circuits and tracking. Replace rotor.

AFTER THE CONTACT POINTS HAVE BEEN ADJUSTED, IT IS ABSOLUTELY NECESSARY TO CHECK THE IGNITION TIMING WITH THE ENGINE COLD.

IGNITION TIMING

Crank the engine until the right-hand mark of the crankshaft pulley lines up with the vertical crankcase joint and the distributor rotor is pointing to the No. 1 cylinder mark on rim of distributor housing. Loosen the lock screw below the distributor retainer and rotate the distributor body clockwise until the

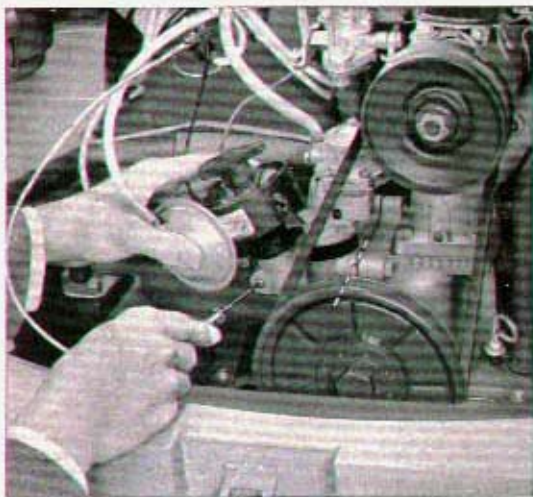

contact points are closed. Now switch on the ignition and rotate the distributor slowly anti-clockwise until the contact points just start to open. This may be seen and heard, for a spark will jump from one point to the other.

To obtain a more accurate adjustment for maximum results, it is advisable to use a test lamp (6 volts) or an ignition timing light. The test lamp should be connected to the coil primary lead terminal and to earth. The lamp will light up as long as the contact points are kept open by one of the four cam lobes of the distributor shaft.

After the adjustment is completed, tighten the lock screw, and clamp the cap on the distributor. Check the ignition timing again.



EXCHANGING FUSES

The fuse box is located below the parcel shelf. When a fuse has blown out, it is not sufficient merely to replace it by a new one. Inspect the electrical system for evidence of short circuits or other faults that may have caused the fuse to blow. Under no circumstances should you use a fuse patched up with tin-foil or wire, because this may result in severe damage. We suggest that you carry with you a set of spare fuses (8 amp.).

REPLACING THE REAR INDICATOR OR STOP AND TAIL LIGHT BULBS

Remove two Philips screws, take out glass insert and replace damaged bulb:

Top - Indicator bulb

Bottom - Stop and tail light bulb

When replacing the stop and tail light bulb the retaining pin nearest to the bulb glass must point downwards. The Philips screws in the glass insert should be tightened evenly but not excessively.



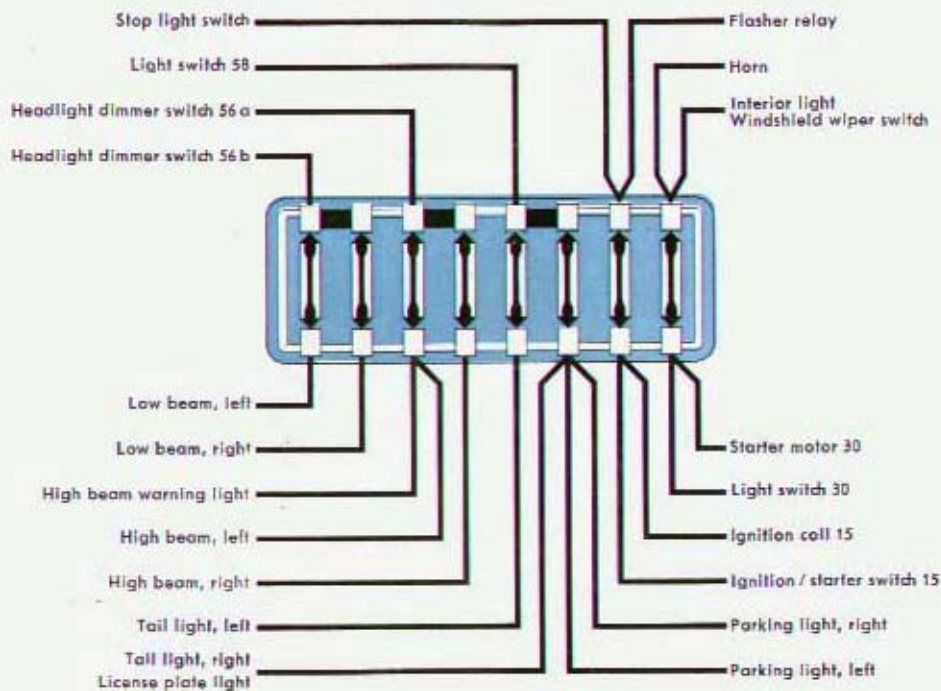

Fuse box below parcel shelf

Warning Light Bulb Replacement

The warning lights for oil pressure, generator charging, flashing indicators, headlight main beam as well as the speedometer and fuel gauge lights are accessible from under the instrument panel. The bulb sockets can be easily removed.

BATTERY MAINTENANCE

Ready starting of the engine depends upon perfect condition of the battery which should be inspected regularly and carefully maintained. The cover can be removed after loosening the snap fastener.



The battery should be checked with a cell tester. This is a voltmeter in parallel with a heavy resistance. The voltage of each cell should not fall below 1.6 volts while taking the reading (10—15 seconds). Otherwise the cell is discharged or defective. Under no-load conditions each charged cell should read 2 volts.

Add distilled water to each cell to bring the level above the plates. The acid level has to be adjusted in accordance with the acid level mark. Losses by evaporation may only be replenished by adding distilled water. Never add acid, unless it is known that acid has been spilled from the battery. Check specific gravity afterwards and compensate if necessary.

Clean terminals with a cloth, or if badly corroded, with a special cleaner. Coat the clean posts and terminals with light grease to prevent corrosion. Then tighten securely and make sure that there is a proper connection to ground.

When laying your vehicle up for a prolonged period, it is advisable to take the battery to a workshop for storage. A battery which is not in constant use will discharge itself in time and this can result in permanent damage to the plates if the battery is not checked about every 4 weeks and charged as necessary.

AIMING THE HEADLIGHTS

If no headlight aiming device is available, proceed as follows:

- 1 - Stand the empty vehicle on level ground 5 m. (16.4 ft.) in front of a dark wall which will serve as a screen. The tire pressures must be correct.
- 2 - Next draw two crosses on the screen according to the sketch.

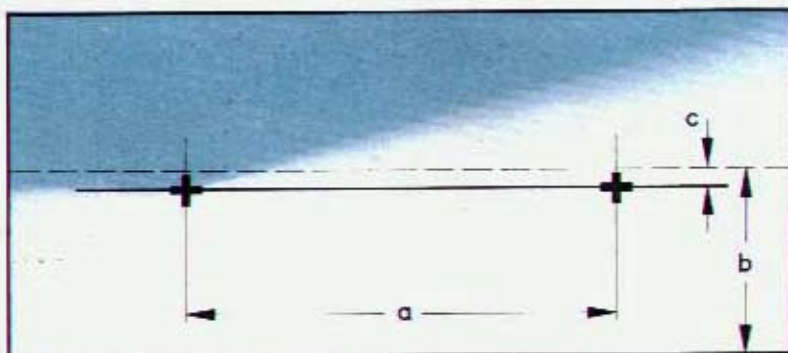

- a - 1012 mm./39.8"
- b - height of the headlamp center from the floor
- c - 50 mm./2"
(at a distance of 5 m./16.4 ft. from the screen)

- 3 - The longitudinal axis of the vehicle must run through the mid point between the two crosses.
- 4 - The headlamps should be adjusted horizontally and vertically with the beams dimmed.
- 5 - Each lamp must be adjusted separately by turning the slotted screws in the headlamp rim with the second lamp covered up.

Vertical Adjustment [upper screw]

The headlamps should be aimed vertically so that the light-dark border line is horizontally on the adjusting line to the left of the cross and slopes upward to the right of the cross.



Horizontal Adjustment [lower screw]

The headlamps should be aimed horizontally so that the angle on light-dark border line is exactly on the center of the cross.

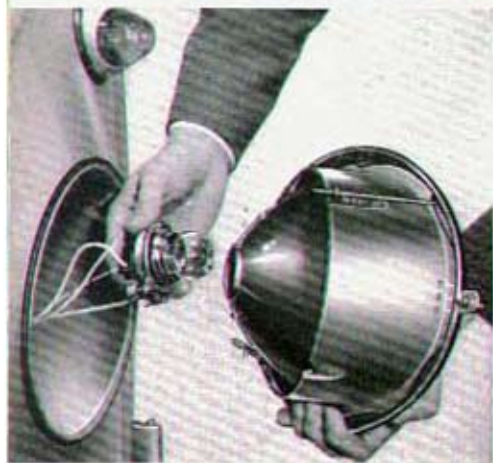

HEADLIGHT BULB REPLACEMENT

Loosen the slotted screw at the headlamp rim. Take out headlamp. Turn the cap to the left and take the holder out of the reflector. Pull the connector off the bulb base, take off the ground and parking light cables and replace the bulb.

When installing, make sure that the lug in the lamp holder engages in the notch provided in the reflector and that the contact strip is located on the base of the parking light bulb. Never touch the bulb with the bare hand, but only with a clean cloth or a paper serviette etc. When replacing a broken headlamp lens, do not touch or wipe the reflector.

BRAKE ADJUSTMENT

Brake adjustment should be performed by an Authorized VW Dealer. However, if an emergency arises where the brakes must be adjusted before you can reach the next repair shop, the following procedure for bleeding and adjusting

can be used: The master cylinder is accessible after lifting the inspection plate in the floor of the cab.

To fill up, use only VW GENUINE BRAKE FLUID.

The fluid reservoir should be kept at least $\frac{3}{4}$ full at all times.



BLEEDING HYDRAULIC SYSTEM

The presence of air in the hydraulic brake system will cause "spongy" brake pedal operation. The system then has to be bled as follows:

- 1 - Remove rubber cap of the bleeder valve of one wheel cylinder and attach one end of the brake bleeder hose to the valve.
- 2 - Place the opposite end of the bleeder hose in a glass container partly filled with brake fluid so that the end of the hose is submerged. The end of the hose should be located as high as possible.
- 3 - Turn the bleeder valve to the open position (1 to 2 turns).
- 4 - Pump the brake pedal several times until bubbles cease to appear in the container. Make sure that enough brake fluid remains in the fluid reservoir, since otherwise air will be sucked in.
- 5 - Keep the brake pedal in the fully depressed position until the bleeder valve is closed.
- 6 - Remove bleeder hose and replace bleeder valve rubber cap.
- 7 - Repeat the operations on the other wheels. Finally check and, if necessary, top up fluid level of master cylinder reservoir.

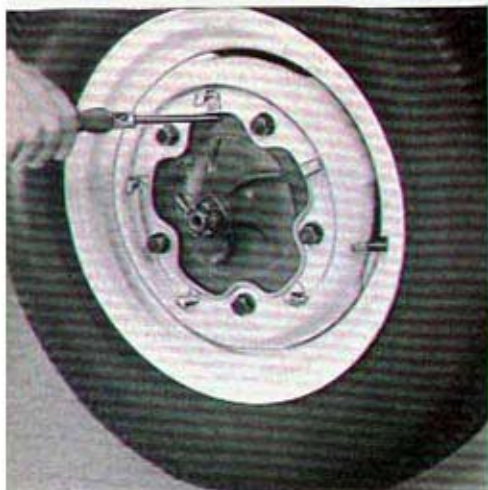

ADJUSTING HYDRAULIC BRAKES

Too much free travel at the brake pedal is an indication that the clearance between brake shoes and brake drums has become too great. The amount of wear can be gauged by looking through the adjusting hole in the brake drum. The brake shoes should be relined when the visual inspection, carried out at every 5000 km. (3000 miles), reveals excessive wear.

The thickness of the brake linings should be not less than 2.5 mm. (.1 in.)

The brake shoes are adjusted as follows:

- 1 - Remove hub caps.
- 2 - Jack up the vehicle and turn forward the wheel to be adjusted, until the hole in the brake drum is in line with one of the adjusting nuts.
- 3 - Insert a screwdriver through the hole and turn the adjusting nut in the direction indicated by the arrows until a light drag is noted when the wheel is turned by hand.

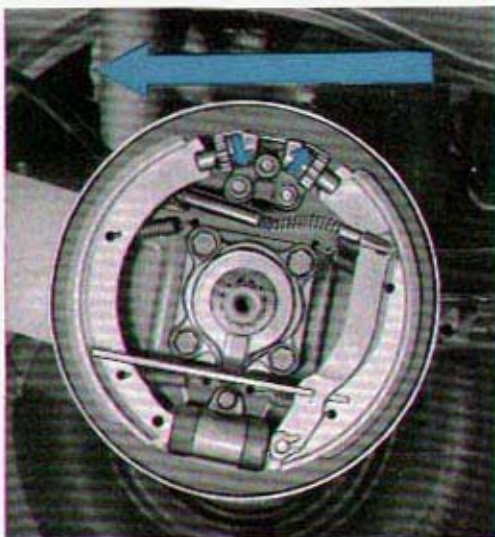
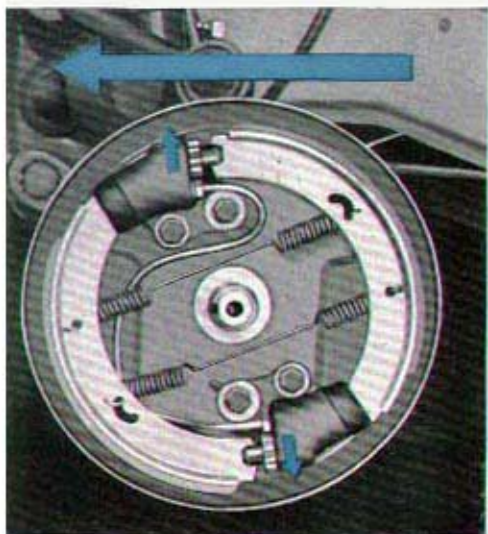

- 4 - Repeat procedure on the other adjusting nut. Note the opposite turning direction of the two nuts.
- 5 - Back off the adjusting nuts by 3 to 4 teeth until the wheel turns freely.
- 6 - Repeat the above operations on the other wheels.
- 7 - Replace hub caps securely.

When adjusting the rear wheel brakes, the hand brake must be released.

It is advisable to depress the brake pedal sharply before and after adjusting the brake shoes to ensure brake shoe centering i.e. the proper position of the shoes relative to the brake drum.

ADJUSTING HAND BRAKE

- 1 - Jack up both rear wheels.
- 2 - Tighten adjusting nuts of the brake cables to a degree which will still allow the rear wheels to turn freely when the hand brake is released.
- 3 - Pull up hand brake lever two notches and make sure both rear wheels have the same braking effect. At the fourth notch it should be impossible to turn the wheels by hand. Lock adjusting and counter nuts.



CLUTCH PEDAL FREE-PLAY

Easy gear shifting and complete transmission of engine output to gears and wheels can only be guaranteed if the clutch is adjusted as specified. Measured at the clutch pedal, this free-play should amount to 10—20 mm.

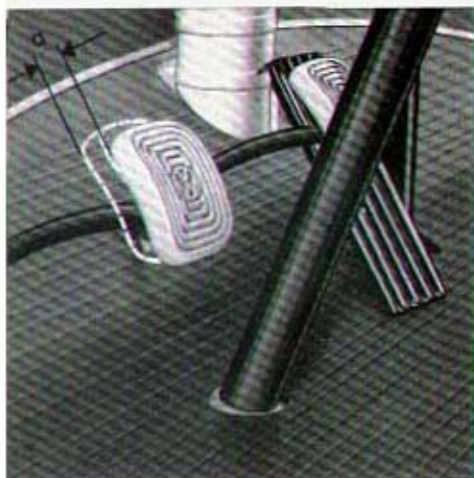

(0.4"—0.8") (a). The clearance may be adjusted at the adjusting nut on the cable end.

- 1 - Release lock nut on the threaded cable end.
- 2 - Adjust clutch clearance by turning the adjusting nut. Depress clutch pedal several times and recheck pedal free-play.
- 3 - When the correct adjustment has been reached, hold adjusting nut in position and tighten lock nut.
- 4 - Grease clutch cable adjusting nut with Universal Grease.

STEERING GEAR

In the straight-ahead position there should be no end play. The play within the steering mechanism should be as small as possible, but care must be taken that the front wheels resume their straight-ahead position after the vehicle has taken a turn. All operations or adjustments required should only be performed by an Authorized VW Dealer.

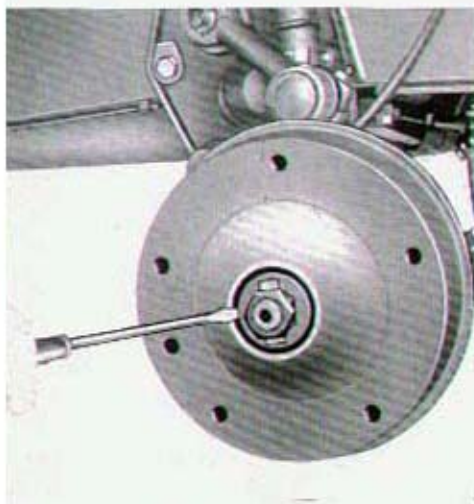

FRONT WHEEL BEARINGS

We recommend that you refer this operation to an Authorized VW Dealer, as maladjustment may cause severe damage to the roller bearings. If circumstances require the removal of a front brake drum, the front wheel bearings are to be adjusted as follows:

Tighten inner nut until the thrust washer can just be moved laterally with a screwdriver and no bearing play can be felt when rocking the brake drum.

Incorrect adjustment can ruin the bearings in a short time. Finally, secure the nuts by bending down the lock plate.

CHECKING AND ADJUSTING TORSION ARM LINK PINS

The torsion arm link pins should be checked and, if necessary, re-adjusted every 5000 km. (3000 miles). The front end of the vehicle is to be raised so that the weight is taken off the wheels.

CHECKING

Rock the wheel by hand to check for end play between torsion arm link and torsion arms. If play is present, adjust torsion arm link pins.

ADJUSTING

- 1 - Back off pinch bolts at torsion arm eyes.
- 2 - Loosen and grease the torsion arm link pins.
- 3 - Tighten the torsion arm link pins to a degree which will still allow a free movement between torsion arms and torsion arm link without perceptible play. To effect this adjustment, first fully tighten torsion arm link pins and then back them off approximately $\frac{1}{8}$ turn. Finally retighten the pins carefully until the first resistance is felt. If no correct adjustment can be effected, the shims are worn and should be replaced by new ones in a VW Workshop.
- 4 - Tighten torsion arm pinch bolts.

After the torsion arm link pins have been adjusted, it is absolutely necessary to check the toe-in.

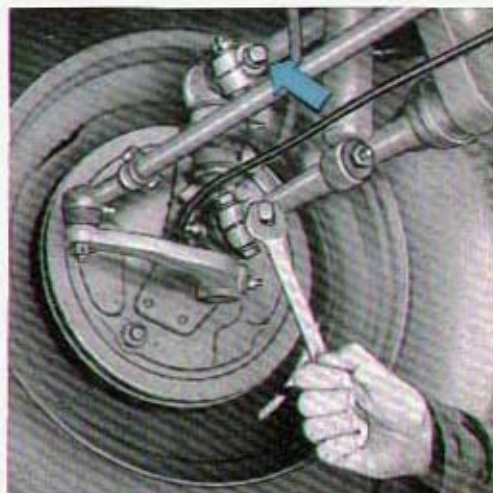

ADJUSTING THE TOE-IN

With the empty vehicle on the ground, front wheel toe-in should be 0 ± 1 mm. ($0 \pm .04$ in.) and with max. permissible gross weight it should be 2—5 mm. (.08 to .20 in.). These values can be accurately checked only with a track tester at the workshops. Inadmissible deviations will increase tire wear and impair road holding qualities.

DOOR BUFFERS AND STRIKER PLATES

The doors of the cab should fit properly in the closed position, otherwise the striker plate requires re-adjustment. Worn striker plates are to be renewed or replaced by oversize types.

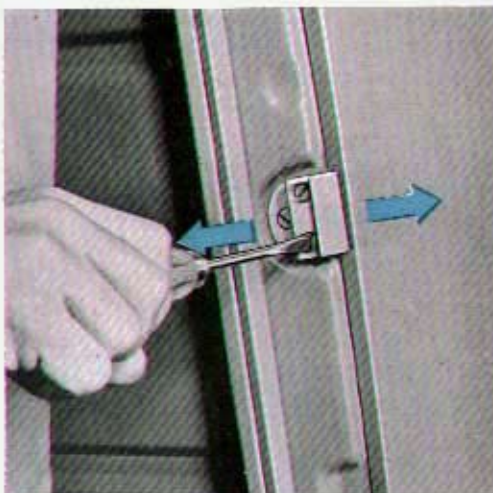

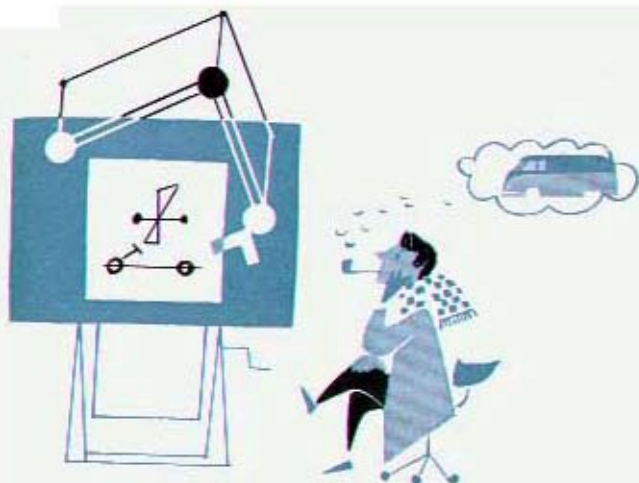

GENERAL DESCRIPTION

ENGINE

The engine, located in the rear of the vehicle, is attached by 4 bolts to the recessed flange of the rubber mounted transmission. Two pairs of cylinders are horizontally opposed. Each pair has one common cylinder head made of light alloy. The overhead valves are located in the cylinder head and are operated from the camshaft by means of push rods, cam followers and rocker arms. The short and counter-balanced crankshaft rests in four bearings and is heat-treated at its four points of support. It drives the camshaft by means of helical gears. The connecting rods are fitted with lead-bronze bearings. The pistons are made of light alloy.

A downdraft carburetor produces the fuel and air mixture to supply the cylinders. The engine is equipped with battery ignition. The spark advance is controlled automatically by a vacuum mechanism.

The oil pump of the full pressure lubrication system is driven by the camshaft and sucks the oil from the crankcase through a strainer and pumps it to the various lubrication points via an oil cooler. In cold weather, when the oil is thicker, an oil pressure relief valve makes it possible for the engine to be lubricated directly, that is, by avoiding the oil cooling system.

The air cooling of the engine is done by means of a fan, which is attached to the extended generator shaft and driven by an adjustable V-belt. The generator pulley is adjustable to permit adjustment of belt tension. The fan sucks in air through an opening in the fan housing, and the air cools the engine by passing through the cylinder fins. A thermostat controls and regulates the amount of cooling air and ensures well-balanced operating and heating temperatures.

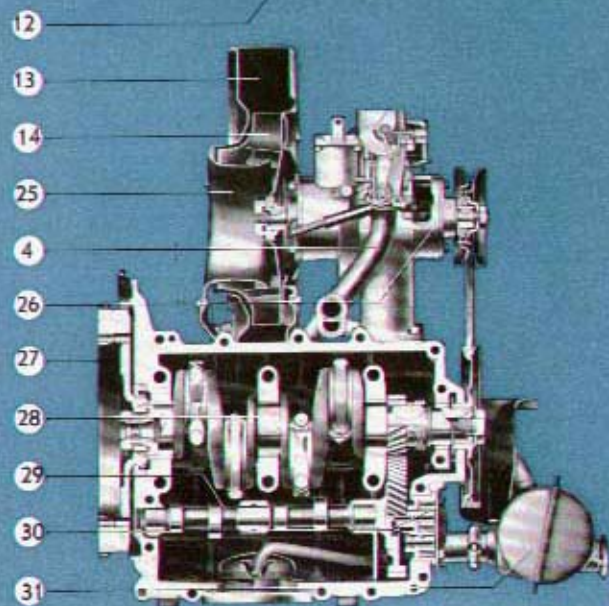
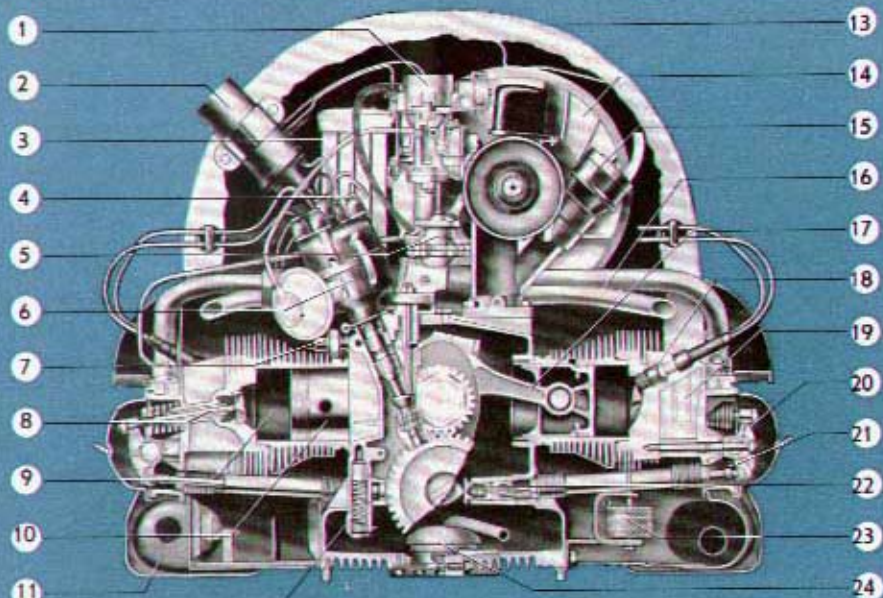

ENGINE

1192 c.c. B.H.P. 40 SAE

- 1 - Carburetor
- 2 - Ignition coil
- 3 - Oil cooler
- 4 - Intake manifold
- 5 - Fuel pump
- 6 - Ignition distributor
- 7 - Oil pressure switch
- 8 - Valve
- 9 - Cylinder
- 10 - Piston
- 11 - Heater junction box
- 12 - Oil pressure relief valve
- 13 - Fan housing
- 14 - Fan
- 15 - Breather and filler assy
- 16 - Preheating pipe
- 17 - Connecting rod
- 18 - Spark plug
- 19 - Cylinder head
- 20 - Rocker arm
- 21 - Valve push rod
- 22 - Cam follower
- 23 - Thermostat
- 24 - Oil strainer
- 25 - Throttle ring
- 26 - Generator (Dynamo)
- 27 - Flywheel
- 28 - Crankshaft
- 29 - Camshaft
- 30 - Oil pump
- 31 - Muffler (Silencer)

TRANSMISSION AND FINAL DRIVE

Power from the engine is transmitted to the gears via a single-plate dry clutch. The transmission provides four speeds forward and one reverse. All models are equipped with a synchromesh transmission. The gears are helically cut to provide silent operation. The drive pinion and the ring gear of the rear axle are cut spirally. The two rear axle shafts swing in the differential housing. Spur wheel reduction gears are provided on the outer ends of the rear axle tubes.

AXLES AND STEERING

The front axle consists of two rigidly joined tubes containing the torsion springs and the suspension arms. The front wheels are sprung independently. The suspension arms form parallelograms assuring proper steering and suspension geometry under all driving conditions. Stops with rubber buffers are provided to prevent excessive rebound.

The rear axle is of the swing half-axle type. The rear wheels are also independently sprung by means of adjustable round steel torsion bars. Double acting hydraulic shock absorbers of the telescope type in front and rear prevent rebound.

The foot brake, which operates on all four wheels, is of the hydraulic type. The hand brake operates on the rear wheels through cables.

The steering gear, which is of a worm and cam follower type, actuates the steering arms of the independent suspension by a draglink and a divided tie rod.

BODY

The body is of a self-supporting, all-steel design, provided with a strengthening frame to support the axles. The position of the load space within the wheelbase ensures an even distribution of the load on all four wheels, no matter how the load is placed. The loading compartment is accessible through a double-wing door from the side and through a hinged rear panel. The tarpaulin of the Pick-Up as well as the bows which are fastened to the platform by means of a few screws can easily be removed and replaced. The driver's compartment, for 3 persons, offers exceptional driving visibility. Adequate ventilation is ensured by vent wings and sliding windows in addition to a fresh air regulator above the windshield.

HEATING SYSTEM

Heated air, which is taken from the air flow warmed up by the engine, is guided through the middle of the vehicle into the driver's compartment by one duct in the floor and two defroster nozzles at the windscreen. The passenger compartment of the Micro Bus is heated by additional vents under the rear seats. The heating system can be turned on and off from the driver's seat.

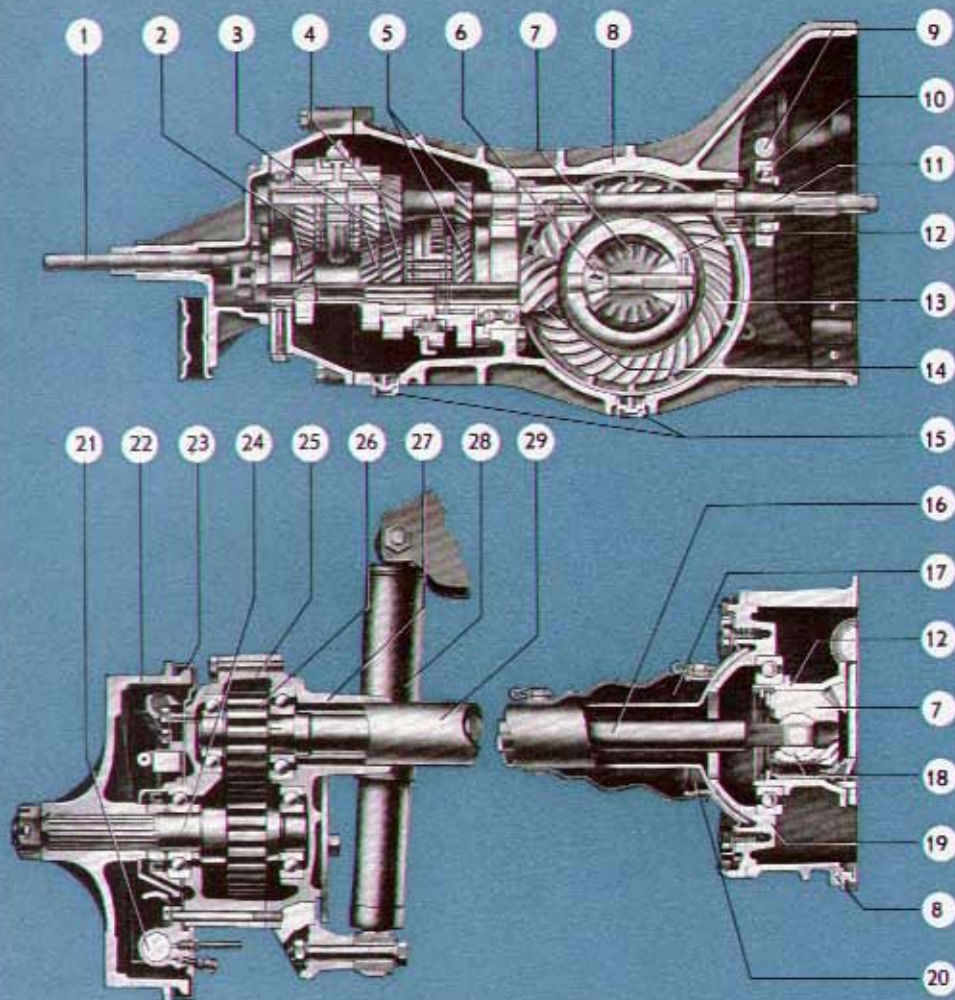

REAR AXLE AND TRANSMISSION

- | | | |
|-----------------------------|----------------------------------|---|
| 1 - Selector shaft, inner | 13 - Ring gear
(Crown wheel) | 21 - Wheel brake cylinder |
| 2 - 4th gear | 14 - Drive pinion | 22 - Brake drum |
| 3 - 3rd gear | 15 - Magnetic
oil drain plugs | 23 - Brake back plate |
| 4 - 2nd gear | 16 - Rear axle shaft | 24 - Reduction driven gear
and shaft |
| 5 - 1st gear | 17 - Dust sleeve | 25 - Reduction gear case
cover |
| 6 - Differential pinion | 18 - Fulcrum plate | 26 - Reduction drive gear |
| 7 - Side gear | 19 - Final drive cover | 27 - Reduction gear case |
| 8 - Transmission case | 20 - Rear axle tube
retainer | 28 - Telescopic shock
absorber |
| 9 - Clutch operating shaft | | 29 - Rear axle tube |
| 10 - Clutch release bearing | | |
| 11 - Main drive shaft | | |
| 12 - Differential housing | | |

TECHNICAL DATA

ENGINE

Design	4 Cylinder, 4 Stroke, Carburetor-Type, in Rear of Vehicle	
Arrangement of Cylinders	Horizontally Opposed	
Bore	77 mm. (3.031")	
Stroke	64 mm. (2.520")	
Capacity	1192 c. c. (72.74 cu. in.)	
Compression Ratio	7.0:1	
Valves	O. H. Type	
Valve Clearance	Intake 0.20 mm. (.008") Exhaust 0.20 mm. (.008")	} to be adjusted when engine is cold
Brake Horsepower (SAE)	40 HP. at 3900 R. P. M.	
Lubrication	Full Pressure (Gear Pump with Oil Cooler)	
Oil Capacity	Metric — 2.5 Liters U. S. — 5.3 Pints Imp. — 4.4 Pints	
Fuel Pump	Mechanical Type	
Carburetor	Downdraft Type Solex 28 PICT	
Cooling System	Air Cooling by Fan, Thermostat-controlled	
Battery	6 Volts, 77 Ampere Hours	
Starter	Electric, 6 Volts, .5 HP.	
Generator	6 Volts, 180 Watts at 2500 R. P. M., with Voltage Regulator	
Ignition Distributor	Vacuum spark advance	
Firing Order	1 — 4 — 3 — 2	
Spark advance	10° before T. D. C.	
Breaker Point Gap	0.4 mm. (.016")	
Spark Plugs	Bosch 175 T 1 Beru 175/14 Lodge H 14 Champion L 10 S or L 85 Firestone 147 AC 43 L Auto-Lite AE 6 or AER 6 KLG F 70	} 14 mm.
Spark Plug Gap	0.7 mm. (.028")	

CLUTCH

Design	Single Disc, Dry
Pedal Free-Play	10 to 20 mm. (.4 to .8")

TRANSMISSION

4 Forward Speeds, 1 Reverse, Gears Synchronized and Silent.

Gear Ratios	First: 3.80 : 1
	Second: 2.06 : 1
	Third: 1.22 : 1
	Top: 0.82 : 1
	Reverse: 3.88 : 1

REAR AXLE

Power is transmitted through a helically-cut drive pinion and ring gear, via two swinging axles and spur wheel reduction gears to the rear wheels.

Ratio	4.125 : 1
Oil Capacity of Transmission and Rear Axle	Metric — 3 Liters
	U. S. — 6.3 Pints
	Imp. — 5.3 Pints

REAR WHEEL REDUCTION GEARS

Ratio	1.39 : 1
Oil Capacity of Reduction Gear Cases	Metric — 0.25 Liter each
	U. S. — 0.53 Pint
	Imp. — 0.44 Pint

CHASSIS

Suspension, Front	Two Torsion Bars
Suspension, Rear	Two Torsion Bars
Shock Absorbers	Double Acting Telescopic Type, Front and Rear
Steering	Ross cam and lever steering gear with rolling stud contact and hydraulic steering damper
Turns of Steering Wheel, Lock to Lock ..	2.8
Turning Circle	about 12 Meters (39 Ft.)
Foot Brake	Hydraulic, Operating on all 4 Wheels
Hand Brake	Mechanical, Operating on Rear Wheels
Wheels	4½ K × 15, Drop-Center Type
Tires	6.40—15
Inflation Pressure	Front: 2.0 kg./sq. cm. (28 lbs./Sq. In.) Rear: 2.3 kg./sq. cm. (33 lbs./Sq. In.)
Ambulance	Front and Rear: 1.8 kg./sq. cm. (26 lbs./Sq. In.)
Wheel Base	2400 mm. (94.5 In.)
Track (Tread)	Front: 1370 mm. (53.9 In.) Rear: 1360 mm. (53.5 In.)
Toe-in (Vehicle in unloaded condition)	0 ± 1 mm. (.04 In.)
(Vehicle in fully loaded condit.)	2—5 mm. (.08—.20 In.)

DIMENSIONS AND WEIGHTS

	Delivery Van		Pick-Up and Double Cab		with enlarged platform	with enlarged wooden platform	Ambulance	Fire Truck
	Micro Bus Kombi	Micro Bus Deluxe	without tarpaulin	with tarpaulin				
Length	4280 (168.5")	4300 (169.3")	4290 (168.9")	4290 (168.9")	4290 (168.9")	4300 (169.3")	4280 (168.5")	4280 (168.5")
(with bumper guards)	4290 (168.9")	4300 (169.3")	4300 (169.3")	4300 (169.3")	4300 (169.3")	4300 (169.3")	4290 (168.9")	4290 (168.9")
Width	1750 (68.9")	1800 (70.9")	1750 (68.9")	1750 (68.9")	2020 (79.5")	1980 (78.0")	1750 (68.9")	1750 (68.9")
Height	1940 (76.4")	1940 (76.4")	1920 (75.6")	2210 (87.0")	1920 (75.6")	1920 (75.6")	1940 (76.4")	1930 (76.0")
Ground Clearance	240 (9.4")	240 (9.4")	240 (9.4")	240 (9.4")	240 (9.4")	240 (9.4")	240 (9.4")	240 (9.4")

Delivery Van and Kombi

Load Space

Mean Length	2700 mm. (106.3")	} approx. 4.8 cu. m. (170 cu. ft.)
Mean Width	1500 mm. (59.1")	
Mean Height	1350 mm. (53.1")	

Luggage Compartment in Micro Bus

Mean Length	700 mm. (27.6")	} approx. .8 cu. m. (28 cu. ft.)
Mean Width	1450 mm. (57.1")	
Mean Height	800 mm. (31.5")	

Pick-Up

Loading Area

Length	2600 mm. (102.4")	} approx. 4.2 Sq. m. (45 Sq. ft.)
Width	1570 mm. (61.8")	
Height of Drop Sides	375 mm. (14.8")	

Height of Tarpaulin above

Loading Area	1200 mm. (47.2")
------------------------	-------------------

Height of platform (unladen)

above ground	980 mm. (38.6")
------------------------	------------------

Locker

Length	1200 mm. (47.2")	} approx. 1.9 Sq. m. (20 Sq. ft.)
Width	1600 mm. (63.0")	
Height	340 mm. (13.4")	
Loading Space65 cu. m. (23 cu. ft.)	

WEIGHT IN Kg. (lbs.)	Unladen Weight (Ready for operation)	Payload	Max. perm. Gross Weight	Number of Seats
Delivery Van	1035* (2282*)	830 (1830)	1865 (4112)	3
Pick-Up without tarpaulin	1065* (2348*)	800 (1764)	1865 (4112)	3
Pick-Up with tarpaulin	1100* (2425*)	765 (1687)	1865 (4112)	3
Double cab without tarpaulin	1165* (2569)	700 ¹ (1543)	1865 (4112)	6
Double cab with tarpaulin	1190* (2624)	675 ² (1488)	1865 (4112)	6
with enlarged platform	1115* (2458)	750 (1654)	1865 (4112)	3
with enlarged wooden platform	1135* (2502)	730 (1610)	1865 (4112)	3
Kombi	1120 (2469)	745 (1643)	1865 (4112)	8
Micro Bus	1125 (2480)	740 (1632)	1865 (4112)	8
Ambulance	1225 (2701)	640 (1411)	1865 (4112)	7
Fire Truck	1155* (2546)	895 (1973)	2050 (4519)	3

* including driver
** with seats and driver

¹) or 5 persons + 375 kg (825 lbs.)
²) or 5 persons + 350 kg (770 lbs.)

	Front	Rear
Permissible Axle Loads in kg. (lbs.) ...	950 (2094)	1015 (2238)
Fire Truck	1000 (2204)	1100 (2425)

PERFORMANCE

Maximum Speed	95 k. p. h. (59 m. p. h.)
Pick-Up with tarpaulin	90 k. p. h. (56 m. p. h.)
Climbing Ability First Speed	26 %
Second Speed	13.5 %
Third Speed	7 %
Top Speed	4 %

REFILL REQUIREMENTS

Fuel Tank Capacity	40 Liters U.S. - 10.6 Gallons Imp. - 8.8 Gallons
Engine	2.5 Liters (5.3 U.S. Pints, 4.4 Imp. Pints)
Transmission and Rear Axle	2.5 Liters (5.3 U.S. Pints, 4.4 Imp. Pints)
Reduction Gear Cases	0.25 Liter each (0.53 U.S. Pints, 0.44 Imp. Pints)
Steering Gear	0.25 Liter (0.53 U.S. Pints, 0.44 Imp. Pints)
Brake System	0.3 Liter (0.63 U.S. Pints, 0.53 Imp. Pints)

FUEL CONSUMPTION

Average Consumption According to DIN 70 030

Delivery Van, Micro Bus, Kombi ..	Metric — 9.5 Liters per 100 km.
	U. S. — 24.5 Miles per Gallon
	Imp. — 29.5 Miles per Gallon
Pick-Up without tarpaulin	Metric — 10 Liters per 100 km.
	U. S. — 23.5 Miles per Gallon
	Imp. — 28 Miles per Gallon
Pick-Up with tarpaulin	Metric — 10.4 Liters per 100 km.
	U. S. — 22.5 Miles per Gallon
	Imp. — 27 Miles per Gallon
Fuel	76 octane number (Res. F 1)
Oil Consumption	Approx. 0.5—1.4 Liter per 1000 km.
	1.7—4.8 U. S. Pints per 1000 Miles
	1.4—4.0 Imp. Pints per 1000 Miles.

The measured average consumption is the actual consumption plus 10%, determined with vehicles at half the permissible payload at a continuous $\frac{3}{4}$ of maximum speed 71.3 k p h. (44 m p h.) on level road.

BULB CHART

V = Volts, W = Watts

Light Description	Designation of Bulb (according to German standard DIN 72 601)	VW Part Number
Headlights	A 6 V 45/40 W	N 17 705 1
Parking lights	HL 6 V 4 W	N 17 717 1
Flashing indicators, front and rear	R 6 V 18 W	N 17 731 1
Tail/stop lights	S 6 V 18/5 W	N 17 737 1
License plate light	G 6 V 10 W	N 17 719 1
Warning lights	J 6 V 1.2 W	N 17 722 1
Speedometer and fuel gauge	J 6 V 1.2 W	N 17 722 1
Dome light	L 6 V 5 W	N 17 725 1
Micro Bus De Luxe		
Clock light	J 6 V 1.2 W	N 17 722 1
Ambulance		
Back-up light	E 6 V 25 W	N 17 710 1
Spot light	E 6 V 25 W	N 17 710 1
Ambulance Identification light (German type)		
	F 6 V 15 W	N 17 716 1

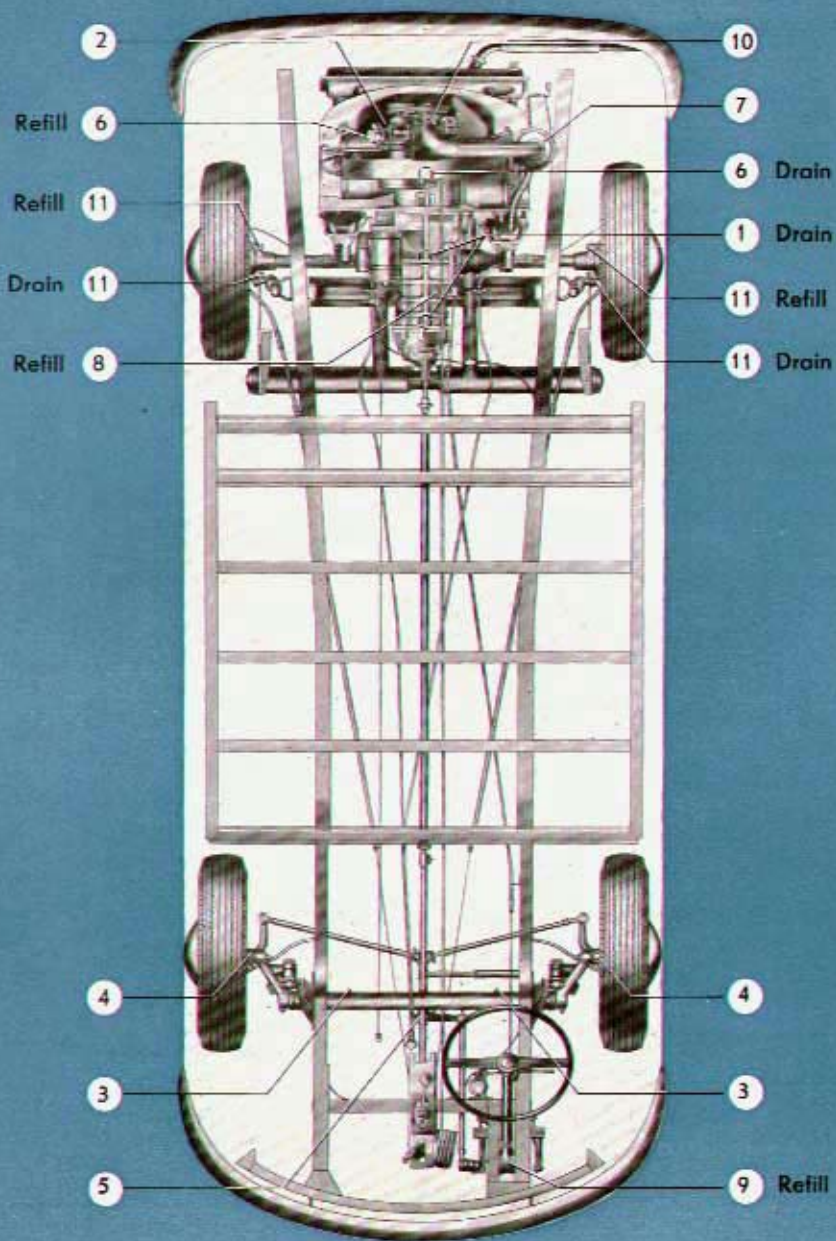

LUBRICATION CHART

500 km. 300 miles	2,500 km. 1,500 miles	5,000 km. 3,000 miles	No.	Lubrication Points	Lubricant	Every
			1/8	Transmission: Clean magnetic oil drain plugs, check oil level	G	
			2	Engine: Check oil level	M	2,500 km. 1,500 miles
			3	Torsion arms *	F	
			4	King pins and torsion arm link pins	F	
			5	Swing lever shaft	F	
				Door hinges	M	
			6	Engine: Change oil, clean oil strainer	M	5,000 km. 3,000 miles
			7	Clean air cleaner	M	
			8	Transmission: Check oil level	G	
			9	Steering gear: Check oil level	G	
			10	Carburetor controls and shafts, fast idle cam Door and hood locks	M F	
			1	Transmission: Change oil, clean magnetic oil drain plugs	G	25,000 km. 15,000 miles
			11	Reduction gear cases: change oil	G	

* tie rod ends with grease nipples if applicable.

LUBRICANTS

Lubricant	Lubrication points	Lubricant	Specifications		
			Temperature °C	Temperature °F	
Engine oil (Trade-mark HD oil for spark ignition engines)	Engine, oil bath air cleaner, door hinges, carburetor controls, felt ring in contact breaker base plate	M	above 30	86	SAE 30
			up to 30	86	SAE 20 w/20
			below 0	32	SAE 10 w
			below -25	-13	SAE 5 w
			below -10	-14	SAE 90
Hypoid oil	Transmission case, reduction gear cases	G	below -10	-14	SAE 80
	Steering gear case	G	SAE 90		
Universal grease	Front axle, swing lever shaft Breaker arm fiber block Door and lid locks	F	Anti-freeze, water-repellent high pressure grease		
Lithium grease	Front wheel bearings	W	Multi-purpose grease		

MAINTENANCE CHART

500 km. 300 miles	5,000 km. 3,000 miles	Operation	Every
		Check adjustment of automatic air intake control	
		Check nuts and bolts on engine, particularly on exhaust system, intake manifold, carburetor and fuel pump for tightness	
		Check nuts and bolts on chassis, body, rear axle, front axle and steering for tightness	
		Check tire pressures and wheel mounting bolts for tightness	
		Check fan belt	5,000 km. 3,000 miles
		Check throttle ring for proper contact on fan housing	
		Clean fuel pump filter	
		Lubricate felt ring in contact breaker plate (one drop)	
		Clean breaker points, check grease at breaker arm fiber block	
		Check contact breaker points and timing	
		Check valve clearance	
		Clean and check spark plugs. Check compression	
		Check rear axle and engine for leaks	
		Check intake and exhaust systems for damage	
		Check clutch pedal free-play	
		Check steering adjustment	
		Check torsion arm link pins, front wheel bearing play, tie rod end dust seals, tie-rod ends, steering damper mounting and toe-in	
		Interchange tires and check tire wear, damage and pressure	
		Check hydraulic brake system lines and connections for leakage and damage Check brake fluid level and adjustment of hand and foot brakes	
		Check thickness of brake linings through inspection hole	
		Check shock absorbers for secure mounting	
		Check battery voltage and acid level. Clean and grease terminals	
		Check operation of complete electrical system and headlight alignment	
		Check adjustment of door lock striker plates	
		Road test vehicle, check foot and hand brake efficiency. Check idling adjustment and timing	
		Clean, grease and adjust front wheel bearings	50,000 km. 30,000 miles

INDEX

	Page		Page
Accelerating	22	Door locks — lubrication points ...	37
Accelerator pedal	7	Driving the VW Transporter	15
— accelerating	22	Driving down-hill	18
Accessories	III	Drying tarpaulin	20
Additives — Engine	32		
— Transmission	33	Economy	22
Air cleaner — cleaning	45	Engine — compression ratio	69
Ambulance — specifications ...	71/72	— description	65
Ash tray	20	— design	69
Axle loads	72	— lubrication (oil change) 29/30	
		— oil change in winter	27
Battery — maintenance	56	— oil level	10
— care in winter	28	— oil strainer	30/31
Body — description	67	— sectional view	66
Brakes — adjusting	58	— technical data	69
— application	17	— type of oil	11/30
— bleeding	59	Engine compartment lid	
— care in winter	28	— releasing check mechanism ..	10
— checking	13		
— description	67	Fan belt — adjusting	46
Breaking-in (running-in) period ...	21	— checking tension	11
		Flashing indicator switch	7
Carburetor — adjusting	48	Foot brake — adjusting	60
— type	69	— description	67
Care of the VW Transporter	41	Fresh air regulator	
Chains	28	— description and operation ...	19
Chassis — care in winter	27	Front axle — description	67
Chassis number	8	— lubrication	35
Chromium-plated parts — care ..	43	— technical data	70
Climbing ability	72	Front wheel bearings — adjusting ..	62
Clutch — design	69	— lubrication	36
— pedal	7	Fuel consumption	73
— pedal free-play	69	Fuel pump — cleaning	48
Controls and instruments	5	Fuel gauge	11
Cold weather hints	26	Fuse box	55
Cooling of engine	65	Fuses — exchanging	54
Delivery Van — specifications	71	Gear lever	7
Dimensions — inside and outside ..	71	Generator	66
Dimmer switch — headlight	7	Ground clearance	71

	Page		Page
Hand brake — adjusting	61	Practical driving	21
— description	67	Ratios — rear axle	70
Headlights — aiming	57	— transmission	70
— changing bulb	58	Rear axle — description	67
Heating — description	67	— lubrication	32
— operation	26	— reduction gears	70
Horn button	7	— sectional view	68
Identification plate	8	— technical data	70
Idling — checking and adjusting ..	49	— transmission of power ..	70
Ignition — breaker point gap	52	Rear view mirror	24
— distributor	69	R. P. M. of engine — permissible ..	69
— firing order	69	Reverse gear	16
— timing	52	Safety in traffic	24
Instrument panel light	13	Seat Adjustment	18
Interior light	19	Sectional view with explanations ..	68
Jack — application	39	Shifting gears	16
Key — doors and ignition	5	Shifting to reverse	16
Kombi — specifications	71	Shock absorbers — design	70
License plate light		Spare wheel	39
— replacing bulb	54	Spark plug — checking and cleaning ..	51
Light switch — positions	13	— gap	51
Lubricants	75	Speedometer	5
Lubrication	29	Speed ranges	21
Lubrication Chart	75	Spots — removal	42
Lubrication points	74	Starting — danger in closed rooms ..	15
Maintenance Chart	76	— in winter	14
Maximum performance	72	— with engine cold	14
Maximum speed	72	— with engine hot	15
Micro Bus — specifications	71	Starting motor	69
Multigrade oils	32	Steering — adjusting	62
Oil consumption	72	— description	67
Oil level — engine	10	— maintenance	62
— steering gear	35	— type	70
— transmission	33	Steering-ignition lock — starting ..	14
Paintwork — preservation	42	— locking	18
Parking your Transporter	25	Steering wheel	7
Passing other cars	24	Stop light — bulb replacement ...	54
Pick-up — specifications	71	— checking	13
Polishing the paintwork	42	Stopping the vehicle — generally ..	18
		— temporarily	24
		Sun roof — cleaning	43
		— operation	20

	Page		Page
Suspension — front	70	Valves — adjusting	50
— rear	70	— arrangement	69
Technical data	69	— clearance	50/69
Tires — inflation pressure	13	Vent wing	7
— maintenance	38		
— M + S	28	Warning lights	
— size	71	— flashing indicator	5/23
— wear	38	— generator and cooling	5/23
Toe-in of front wheels	71	— headlight	5/23
Toe-in, adjusting	64	— oil pressure	5/23
Tools and accessories	III	— replacing bulbs	56
Track (tread)	71	Washing your vehicle	41
Transmission — description	67	Weights	72
— oil change and		Wheel base	71
capacity	33	Wheels — balancing	39
— sectional view ...	68	— changing	39
— technical data	70	— rim size	70
Turning circle	70	Windows	19
Type of fuel	12	Windshield — cleaning	44
Upholstery — care	43	Windshield wiper switch	7
		— cleaning blades	19



VW Transporter, Sectioned

- 1 - Pedals
- 2 - Steering gear
- 3 - Hand brake lever
- 4 - Brake master cylinder
- 5 - Gear lever
- 6 - Front axle
- 7 - Front shock absorber
- 8 - Spare tire and wheel
- 9 - Jack socket
- 10 - Fresh air regulator
- 11 - Heated air duct
- 12 - Side member
- 13 - Torsion bar seat
- 14 - Fuel tank
- 15 - Transmission
- 16 - Rear shock absorber
- 17 - Reduction gears
- 18 - Air cleaner
- 19 - Carburetor
- 20 - Distributor
- 21 - Generator
- 22 - Muffler (Silencer)
- 23 - Battery

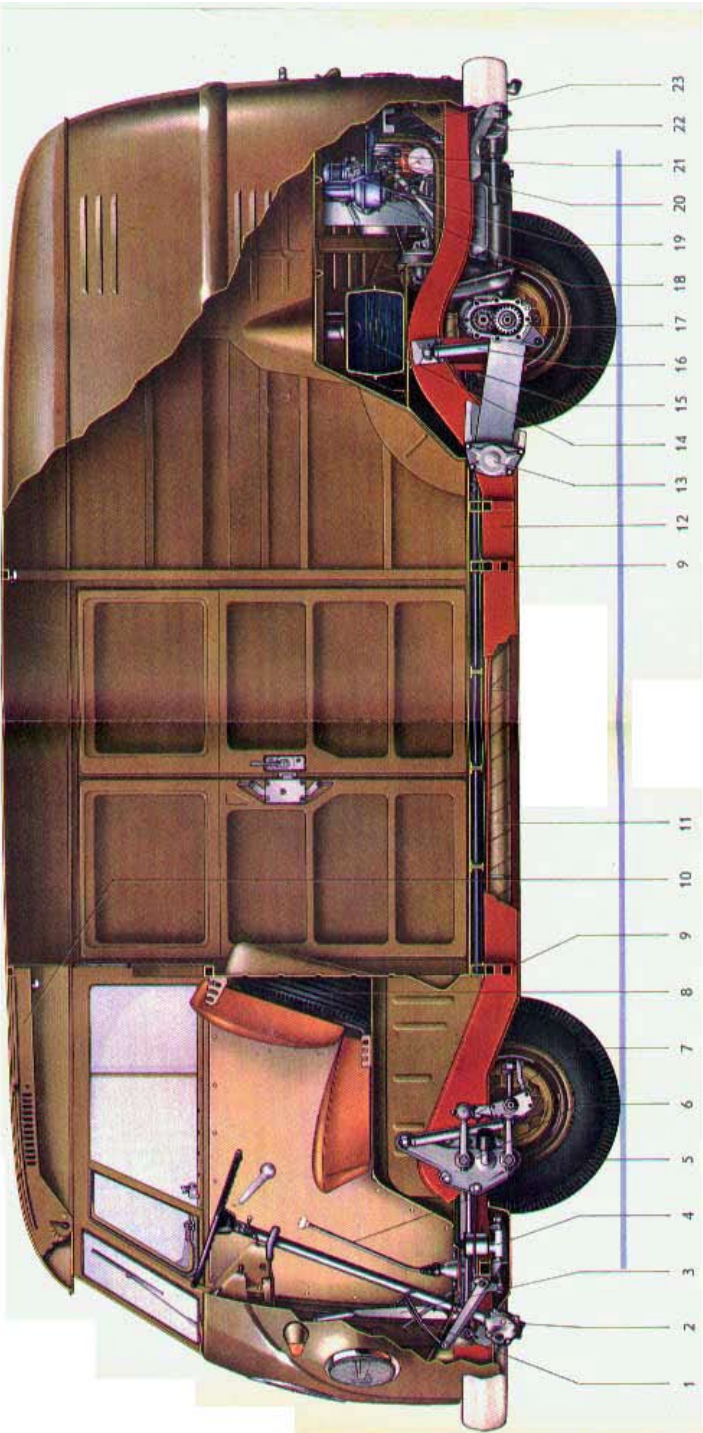

Tools and Accessories

- 1 Fan Belt
- 1 Tool Roll
- 1 Spare Wheel
- 1 Jack
- 1 Hub Cap Removal Tool
- 1 Square Key
- 1 Combination Pliers
- 1 Screw Driver 0.8
- 1 Screw Driver 0.5
- 1 Socket Wrench 14 mm.
- 1 Socket Wrench for Spark Plug, Wheel Bolt, Pulley and Jack
- 1 Open End Wrench 8/12 mm.
- 1 Tommy Bar (Mandrel) for Socket Wrench
- 1 VW Service Booklet

Copyright - All rights reserved.

May not be reproduced or translated in whole or in part without the written consent of Volkswagenwerk.

Specifications subject to alteration without notice.

