

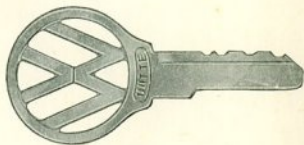

**Your new Volkswagen Station Wagon**





<b>Keys</b>	<b>2</b>
<b>Getting acquainted</b>	<b>8</b>
<b>Driving</b>	<b>16</b>
<b>When it gets cold</b>	<b>24</b>
<b>Keeping it clean</b>	<b>26</b>
<b>Trouble shooting guide</b>	<b>30</b>
<b>Lubrication</b>	<b>40</b>
<b>Preventive Maintenance</b>	<b>52</b>
<b>How your Volkswagen works</b>	<b>72</b>
<b>Technical data</b>	<b>76</b>
<b>Index</b>	<b>78</b>
<b>Reference Data Record</b>	<b>back cover</b>

# Your key to get to know your new car

Welcome to the Volkswagen driving fraternity. For it is a fraternity, really. Just as the VW is a somewhat unique automotive concept, VW owners quickly pick up the reputation of being automotive aficionados. One of the virtues of the Volkswagen is that it brings back the pleasure of driving — instead of being driven in — a car. And you will enjoy your Volkswagen even more if you are completely familiar with its operation. Thus, the purpose of this book is to provide you with all the knowledge you will need to lead VW bull sessions or cope with most any situation you could encounter. We even explain, for instance, what to do if you are stuck in the snow, although we know that you probably never will be. Sometimes you may think we are being a little basic. However, if you've never driven a Volkswagen before you may be unfamiliar with the location of certain switches or knobs. And if you have a young driver in your family this manual will be an excellent addition to his driver training. Many pages are devoted to lubrication and routine preventive maintenance. Why? Under certain circumstances you could be called upon to service your Volkswagen yourself. However, we recommend that you let your Authorized VW Dealer take care of your vehicle. He has the equipment and factory-trained mechanics who do nothing but work on Volkswagens all day long. So they're pretty good at it. It will be valuable for you to read this owner's manual completely through to see what information it contains. You may learn a lot of new things which will help you get the most out of your Volkswagen. We wish you many miles of pleasant driving.

# This key will open all the doors for you

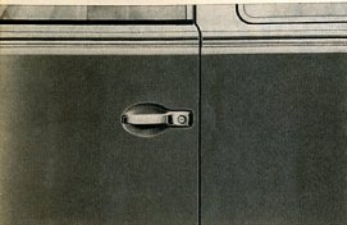
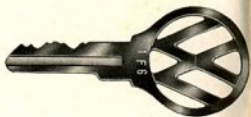

## **this one**

the ignition key locks or unlocks both driver's cab doors by turning clockwise or counterclockwise, respectively.

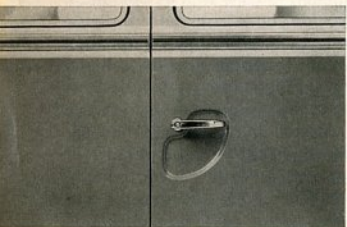

## **and these two**

The side loading doors may be likewise locked from the outside or from the inside by turning the locking knob. To open these doors flush against the side of the vehicle all you have to do is to remove the retaining straps from the inside hook.



## **and this one**

The rear flip-up door can be locked or opened only from the outside. When raised it will lock in one of two open positions automatically. To release it just raise the door slightly higher and remove the checkrod from the stop position.



## This key opens the gas tank

### here's where you find it

The square key is located on the wall beside the steering column.

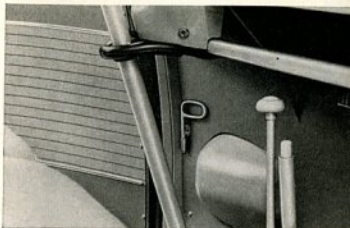

### the gas tank

You can open the gas cap door with the square key.

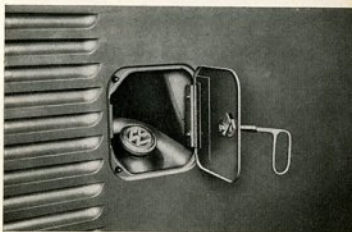

### the engine compartment

The engine compartment lid springs open automatically when the button is pressed in. A support spring holds the lid open. To close just press the lid down until the lock engages.





**Now take your key, open the door**

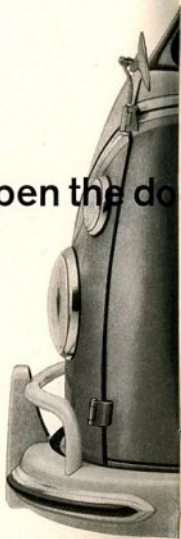

or and step inside



### Sliding Door

If your Station Wagon has a sliding door instead of the normal wing door, note the following instructions:

To open the door, press the handle down. The door slides back easily and is held open by a lever.

To close the door, press the handle down and slide the door forwards firmly until it engages. Then pull the handle up so that the rear edge of the door contacts the body properly.

The door can be locked to prevent pilfering.

Please remember that the sliding door must always be closed when the vehicle is in motion.

To get out of the passenger compartment, just pull the door handle to the rear. When the vehicle is in motion, the door can be secured by pressing the locking lever forward.

## Sit down and make yourself comfortable

The comfortable individual driver's seat adjusts separately to an infinite number of combinations. The seat slides back or forth into six different positions (4-inch

play) by turning the seat adjustment lever in the front of the seat upwards. The back rest can be adjusted forward by rotating the infinite adjustment knobs.





# See to it that all your passengers are comfortable too

**Reversing the middle seat.** For long trips or for a car pool you can arrange the middle seat to face rearward, as in a club car. This is convenient for conversation or even a few rubbers of bridge. Follow the instructions below for unfastening the seat.

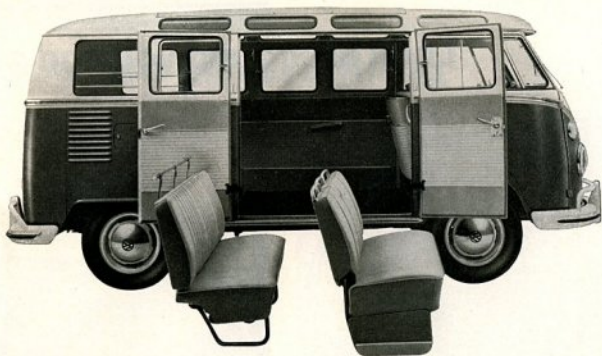

## Want to carry a lot... Just take the seats out

**Removing the rear seat.** To remove the rear seat from the VW Station Wagon you will need the hexagonal wrench from your tool kit. Unfasten the hexagonal screws which hold the brackets from underneath and remove the seat.

**Removing the middle seat.** In the VW Station Wagon you can remove the middle seat to load cargo by unfastening the hexagonal screws securing it to the floor.



Look all around you and get

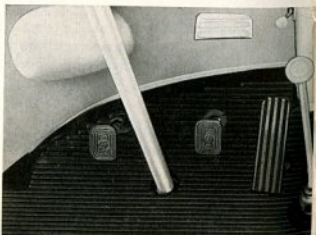
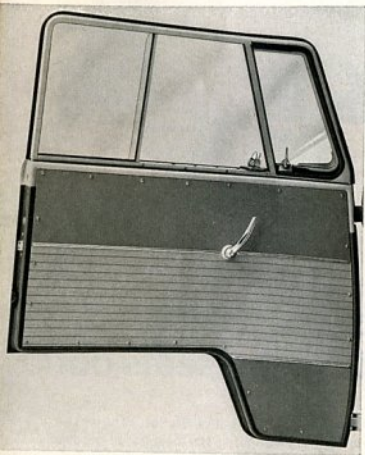

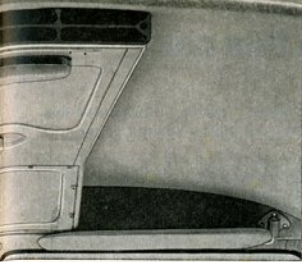

acquainted with everything

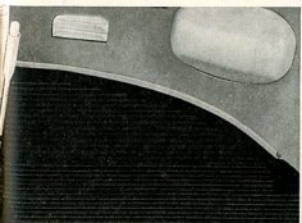
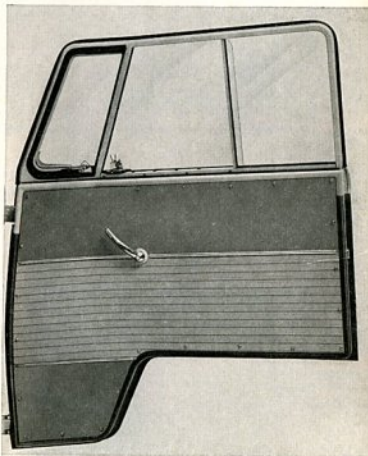
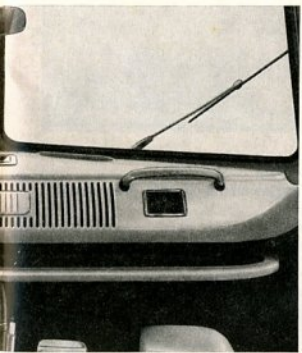

# Plenty of fresh air in this car

You'll get lots of fresh air in this VW Station Wagon. There are 10 windows that can be opened and 15 more to let in sunshine. 25 in all. Plus a sunroof up top.

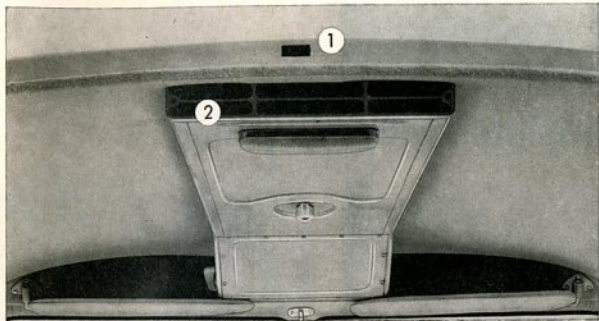

1. A sunroof you can open.
2. A ventilator that changes all the air once every minute.
3. A window that pivots.
4. A window that slides.
5. A door handle that opens and locks safely.

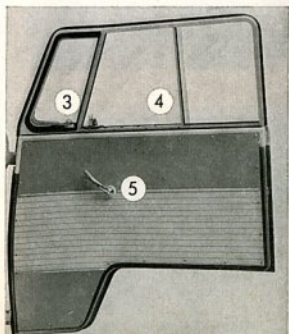
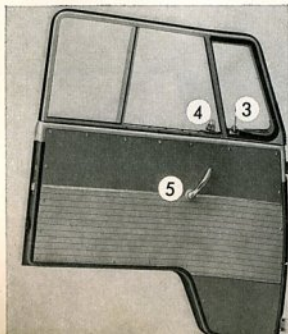

**1.**

To open the sunroof you turn the handle to the left, slide the sunroof as far open as you like, then lock it in place by turning the handle to the right.



**2.**

The lever to the left of the duct turns on to one of three positions: to turn it off, move the lever all the way to the rear. The handle in the center of the duct directs the air into the cab (by turning it counter-clockwise) or passenger compartment (by turning it clockwise).

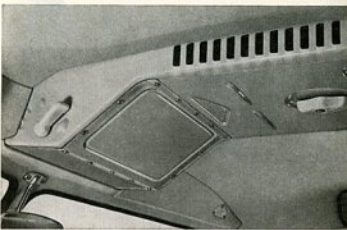

**3/4.**

The vent window directs air into the front seat area without any draft. You can if you want even more fresh air, slide the side windows to the rear after squeezing the release mechanism.

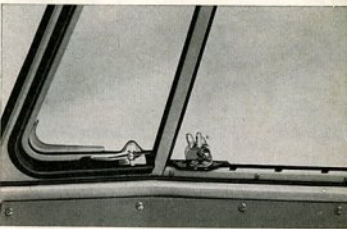

**5.**

To open the door, push the door handle to the rear. To lock it, push the door handle forward.

When leaving the vehicle, lock one door from inside with the lever and then lock the other door from outside with the key.

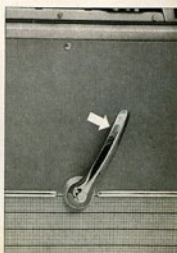

**Look ...  
you can see all controls at a glance**



- 6. Gas gauge
- 7. Headlight switch
- 8. Turn indicator lever
- 9. Speedometer
- 10. Ignition switch
- 11. Defroster vents
- 12. Warning lights
- 13. Windshield wiper rotary switch
- 14. Safety flasher switch
- 15. Ashtray
- 16. Windshield washer

**13/16.**

The windshield wipers are controlled with a rotary switch, which has two positions for different wiper speeds.

The windshield washer is operated by pressing down the rubber bellows. This pumping action can be repeated until the windshield is clean. Do not forget to fill the container from time to time. The opening is accessible after unscrewing the plastic ring and lifting off the rubber bellows which forms the pump. The container holds about a quart.

The addition of 25% methylated spirits (3 parts water to 1 of meths) to the water in the container in winter will prevent it from freezing down to a temperature of  $-12^{\circ}\text{C}$  ( $10^{\circ}\text{F}$ ). An anti-freeze solution can be used instead of meths.

**9/12.**

The central dial contains the speedometer, mileage indicator, warning lights, and turn indicator arrows.

**6.**

The gas gauge will tell you instantly how much gas you have in your tank. When the needle points to reserve (R) you have enough gas to go approximately 30 miles.

**15.**

The ashtray in the top of the dashboard can be removed for emptying by pushing it upward from under the dash panel. The ashtrays in the passenger compartment of the VW Station Wagons are pulled up for removal.

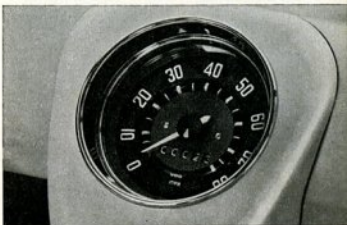

... and everything is easy to reach

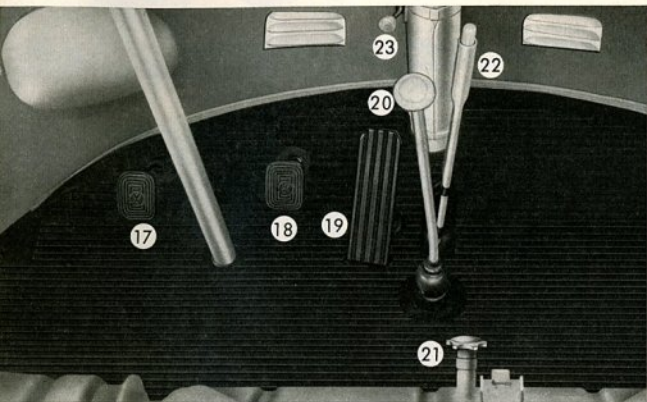

- 17. Clutch pedal
- 18. Brake pedal
- 19. Accelerator pedal
- 20. Gear shift lever
- 21. Heater control knob
- 22. Hand brake
- 23. Heater vent control



**21/23.**

You can warm up the VW Station Wagon by turning the heater control knob counter clockwise — shut off the heater by turning the knob clockwise.

The lever for the heating in front of the hand brake regulates the flow of warm air to the foot well or to the defroster vents.

Lever up -a- warm air to foot well

Lever down -b- warm air to defroster vents

If you open the vent wing in the door slightly at the same time the heater output will increase noticeably.

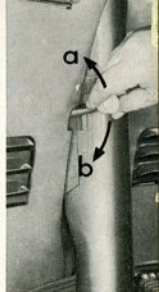

**17/19/20.**

The two pedals used in shifting gears, the clutch and the accelerator, are side by side, conveniently positioned to use.

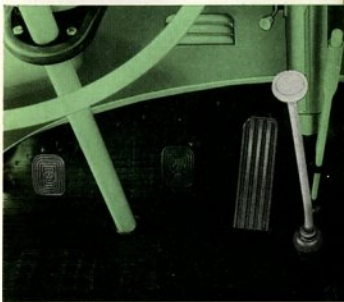

**18/22.**

The positive action hand brake can be used for parking or in an emergency situation.





## Now take your key and

First switch on the ignition by turning the key to the right until the red and green warning lights in the speedometer come on. Then operate the starter without delay by turning the key further to the right.

When starting a warm engine, depress the accelerator pedal slightly. At low temperatures and when engine is cold, depress pedal fully, then release it before switching on the ignition. This enables the automatic choke device to close the choke valve.

In cold weather the engine and transmission oils tend to become thick. Therefore, you should also declutch when starting so that the starter motor has to turn only the engine. Do not race the engine when it is completely cold.

#### Non-repeat ignition lock

If the engine does not start within the first 10 seconds, pause for about that length of time to rest the battery before repeating the starter operation. The ignition will have to be switched off first and then on again as a non-repeat lock in the switch prevents the starter from being operated repeatedly when the ignition is on and thus being damaged by the engine when it is running.



start the engine

# Put it into first and off you go

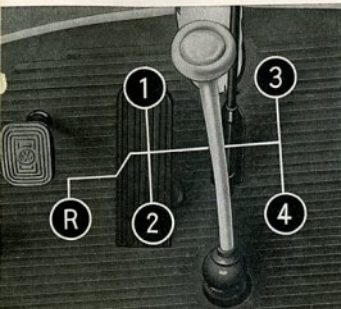

## Starting off

Depress the clutch as far as possible.

Shift to the first gear and release the hand brake.

Engage the clutch by allowing the pedal to return slowly, and simultaneously depress the accelerator pedal. The vehicle will start to move forward.

Gradually increase the pressure on the accelerator pedal and remove your foot completely from the clutch pedal, as the clutch is now fully engaged.

## To shift to the high gears

Take your foot off the accelerator pedal, simultaneously depressing the clutch pedal. Shift gear lever into the next position.

Engage the clutch gently by gradually taking your foot off the pedal, and at the same time depress the accelerator pedal, as before.

## To downshift to a lower gear

If you are driving in slow city traffic or wish to downshift as you approach a curve or steep incline, release the accelerator pedal and depress clutch pedal.

Shift to the next lower gear.

Release clutch pedal and depress accelerator pedal.

Note that because of the Volkswagen's synchromesh gears, you do not need to come to a complete stop to shift into low.

## To shift into reverse

Reverse gear should never be engaged unless the vehicle is at a standstill. To engage the reverse gear from neutral, press straight down on the gear shift lever and move it to the left and rearward.

# Speed ranges for shifting

## Upshifting

first gear 0 to 15 mph  
second gear 6 to 28 mph  
third gear 12 to 45 mph  
fourth gear 20 to 65 mph

## Downshifting

fourth to third 45 to 20 mph  
third to second 28 to 12 mph  
second to first when barely moving.

## Do's and Don'ts of shifting

A few tips from professional drivers and automotive service experts may make shifting easier for you (and may save you a few dollars in repair bills).

Do not over-rev the engine in neutral or in gear. On the other hand you should not labor the engine by driving too slowly in any gear.

Do downshift in plenty of time to keep the engine at the best rpm.

Do use the ball of the foot, not the toe or heel when clutching.

Do not rest your foot on the clutch when driving. When you stop temporarily and are in neutral, take your foot off the clutch pedal.

Do not rest your hand on the gear shift lever.

Do not "slip" (partially disengage) the clutch in slow traffic or on a hill. Downshift and take your foot fully off the clutch pedal.

1st gear



2nd gear



3rd gear



4th gear



# And off you go ...

**Economical operation** is one of the outstanding features of your Volkswagen. However, squeezing a few extra miles from each gallon of gas depends largely on your manner of driving.

**To apply the gas**, depress the accelerator pedal gradually and only to the extent necessary to reach the desired speed. Flooring the pedal rapidly does not substantially improve acceleration but results only in increased fuel consumption and jerky starts.

**For highway driving**, maintain a steady and moderate speed when possible. You will find that the Volkswagen, as any other vehicle, is easier to drive at approximately  $\frac{3}{4}$  of the top permissible speed for any given gear. And your gas mileage may surprise you.

**Slow down gradually** by gently pumping your brakes. Suddenly jamming on your brakes can only be justified as a final resort in an emergency as it can cause a collision from the driver in back of you. It can also cause locking of the wheels and loss of control.

**You should slow down**, and downshift if necessary, just before approaching a sharp curve, not too far in advance or while negotiating that turn. Downshifting before going down a steep hill will add a measure of safety as well as preserving your brakes.

**You watch the road, the flashing lights will watch the Volkswagen**

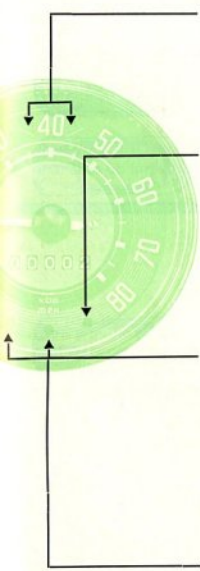

**Green arrows**

The green arrows at the top of the speedometer show that the turn signal indicators are blinking. They will automatically shut off when your turn is completed.

**Green light**

When you turn on the ignition the green oil pressure light will go on. This light should go out when the engine is started and the oil pressure increases. If it does not go out in a few seconds or if it lights up while you are driving, stop immediately and investigate.

(See page 35 in the Trouble Shooting Guide.)

**Red light**

As above, this light, which simultaneously controls the generator and cooling system, will come on when the engine is idling or the ignition is switched on. The light should go out as the clutch is engaged and the engine speed increased. If it does not, damage can be caused by further driving of your Volkswagen.

(See page 35 in the Trouble Shooting Guide.)

**Blue light**

The high beam of your headlights can be blinding to on-coming drivers. The blue light will tell you when you should depress the headlight dimmer button.

## You can park in a Volkswagen-size parking space

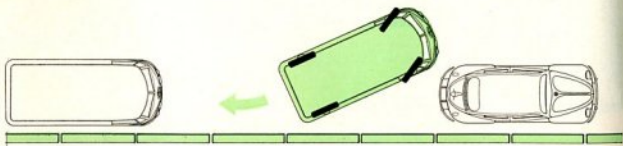



When curb (parallel) parking, stop with your rear wheels level with the rear wheels of the vehicle in front of the space. Turn the steering wheel sharply to the right and back your vehicle slowly into the gap

When you just clear the vehicle ahead of you, turn the steering wheel fully to the left, and back up further toward the curb.

---

---

Now turn the steering wheel to the right again and pull up a little bit until your Volkswagen is centered between the cars in front and in back of you.

---

---

When parking on a steep grade, turn the wheels toward the curb and set the hand brake to prevent the vehicle from rolling. As a precautionary measure, it is advisable to engage first or reverse gear in addition to the hand brake. (When you park on the level, however, be sure to leave the vehicle in neutral. This will prevent damage to the transmission should another car bump into your parked Volkswagen.)

---

---

## Ice and snow...

**Brakes.** At the beginning of the cold season, the guide tubes of the brake cables should be thoroughly lubricated with cold-resistant grease. See your Authorized VW dealer.

**Door locks.** Locks can freeze up in the winter, especially if water gets into the lock cylinder. A frozen lock can be opened by warming the key before insertion and then squirting anti-freeze into the lock cylinder.

**Chains.** If you do not install snow tires you should use chains when the roads are heavily covered with snow. Have the chains adjusted to the wheels if you wish to avoid loss of time and inconvenience later on. When driving on long stretches that are free from snow, the chains should be removed to avoid unnecessary wear of both chains and tires.

**The battery.** There is greater strain on the battery in winter than in warmer seasons because of the increased consumption of current when starting the engine and using the lights earlier in the evening. Also it is characteristic of any battery that its efficiency decreases at lower temperatures. If the vehicle is used mostly over short distances, the battery may require additional recharging. Have the battery checked often during the winter, and make sure that the ground connections and cables between battery and starter are clean.

**The accelerator, clutch and heating cables,** and the adjusting nut for the clutch cable should be checked for freedom of movement at the beginning of winter, and if necessary, cleaned and greased.

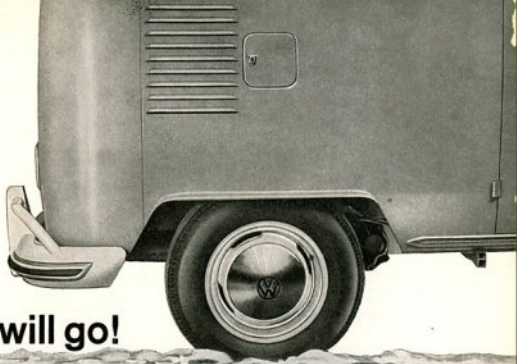

**... you will go!**

**Spark plugs.** The normal gap is .028". In extremely cold weather reduction of the gaps to .016" to .020" will aid starting considerably.

**Engine oil.** If temperatures below freezing are expected, use SAE 10 W oil, which may remain in the engine until the next regular oil change. If you add oil between regular changes, SAE 10 W oil may be used in cold weather and SAE 30 oil when it's warmer. Different viscosity grades can be mixed but be sure to use the same brand and type of engine oil.

If your Volkswagen is used mostly for short distances, especially when it's cold or dusty, have the oil changed at more frequent intervals, say every 1,500 miles. Under extremely cold conditions change every 750 miles.

In areas where below — 13° F temperatures prevail, use SAE 5 W; change every 750 miles, and clean oil strainer at the same time. Caution: Avoid sustained speeds above 55 miles per hour when using SAE 5 W oil.

#### **Transmission Oil**

The SAE 90 oil can generally be used all the year round. It need only be replaced by the thinner SAE 80 grade in countries with arctic climates.



**Once in a while it also needs water**

**Washing your vehicle.** Wash your new Volkswagen frequently during the first weeks.

Soak the exterior finish of the body and wheels with water, then remove dirt with a sponge. Clean the sponge frequently to avoid scratching the finish. Rinse the body thoroughly to remove all soap or cleaner. After washing, rub down with a clean chamois to prevent water spots, and wax.

**Waxing.** Waxing will restore to the finish certain important properties it may have lost by exposure to the weather or in washing. A special preservative (L 190) for the finish of your Volkswagen can be obtained from your VW Dealer. The body should be waxed every eight to ten weeks — in any case, after each soap or detergent washing, as already mentioned. Follow directions on the preservative container.

**Polishing.** You should polish your Volkswagen only if its appearance has been strongly affected by road dust, sunlight and rain, when the application of the preservative no longer restores the original lustre. Avoid the use of abrasives or chemically harmful products, even if their first application seems to give satisfactory results. A special polish (L 170) for treating the synthetic-resin finish is also obtainable from your VW Dealer.

Before polishing, the car must be washed and dried carefully. Apply polish with a soft cloth, using straight horizontal or vertical strokes. Soon you will feel a slight resistance indicating that the ingredients of the polish have settled into the finish and the solvent has evaporated. Rub body with a clean cloth until the high gloss is restored,

**Never wash, wax or polish the vehicle in sunlight.**

**Tar spots.** An unpleasant sight, to be noticed particularly on light-colored vehicles, are tiny tar spots, which are picked up on hot days when driving on newly tarred roads. Tar can corrode the finish within a short time and should be removed immediately. Use gasoline, kerosene or turpentine then wash with a mild, lukewarm soap solution and rinse.

**Insects** are caught especially during the night, in hot weather, by the front end of the vehicle. Once baked on they are very difficult to remove with water and sponge, but should be treated with lukewarm soap solution.

**Parking under trees.** In the summer, trees often spot cars parked under them. These spots can be removed easily if washed immediately with detergent and warm water. Apply a coat of wax afterwards.

**Cleaning sunroof.** The plastic sliding roof does not require any special attention. It is, however, essential to clean the top regularly. When very dirty it should be cleaned with a detergent solution or a normal plastic cleaner. A hand brush can be used to clean the grained surface of the top but take care that the brush does not scratch the paint at the edges of the sliding roof. After cleaning, the top should be rinsed thoroughly with clear water.

Spots can be removed by wiping briefly with a gasoline-moistened cloth, then washing with a luke warm detergent solution. The spots should not be removed with paint thinner, chlorine base spot removers or similar solutions as these will attack the plastic material.

**Chromium plated parts.** All chromium plated trim should be treated, when dry with a special VW chrome cleaner called Chromlin. Apply thinly and allow to dry for 10 minutes before polishing with a dry cloth.

**Care of the upholstery.** Clean leatherette upholstery with a soft cloth or soft brush taking special care to remove dust and dirt from the seams. Best results can be obtained by using a soft whisk broom and suds of any mild soap (castile or olive oil base) in lukewarm water (rain, boiled, or soft water). Use the water sparingly, as the upholstery otherwise requires a long time to dry if water trickles through the stiches. Soaked-in spots can be removed by carefully using a rag moistened with gasoline or alcohol. Spots caused by shoe polish can be removed by means of turpentine. Use these agents carefully and sparingly. After cleaning use a soft clean cloth to polish the surface of the leather. Never use solvents such as trichlorethylene or paint thinner or furniture polishes, oils, varnishes or cleaners on leatherette upholstery. They will injure the finish.

**Cleaning Glass.** Windows can be cleaned by washing with warm water and wiping dry with a clean, soft linen cloth. To facilitate this task on the windshield, the arms of the windshield wipers may be tilted forward. To clean exceptionally dirty windows, use alcohol or household ammonia and lukewarm water.

**Windshield wiper blades.** The rubber wiper blades should also be wiped clean with a detergent and soft cloth. The blades should be replaced if they are worn.

**Touch-up pencils.** VW paint touch-up pencils, in perfect-match colors, are available from your Authorized Volkswagen Dealer for retouching small scratches.

# Here is what to do when trouble troubles you

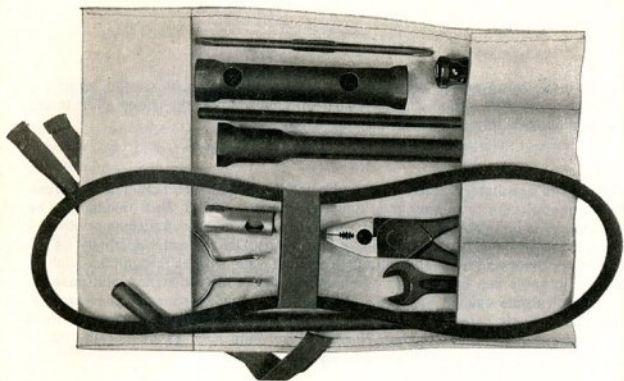

Your Volkswagen should repay you with trouble-free driving if it receives regular preventive maintenance.

Should you ever encounter difficulty starting your engine or have trouble on the road there are a few simple repairs which you can make to get your VW going again. Locate the **PROBLEM** and **PROBABLE CAUSE** of your trouble in the Guide on the following five pages and follow the directions on **WHAT TO DO**.

If the trouble is serious or you are uncertain as to its origin be sure to see an Authorized VW Dealer as soon as possible.



**PROBLEM**

VW will not start: engine will not turn over or turns over too slowly.

**PROBABLE CAUSE**

1. Run down or dead battery

2. Loose connection

A. At battery

B. At starter

C. At ignition switch under cover on dashboard

D. At light switch or fuse box

3. Starter defective

VW will not start: engine turns over.

4. Loose connection in ignition system

5. Loose connection in primary circuit to coil

**WHAT TO DO**

1. Push to start the vehicle (turn on ignition, put in 3rd gear at a speed of approximately 15mph, release clutch slowly). Have battery charged and cause of high current consumption checked.

2. Make sure that all connections are tight.

A. Check both cable connections on battery and grounded end of ground strap.



B. Check connections at solenoid, mounted on starter, under right rear of vehicle.

C. Check push-on connectors for tightness.

D. Check push-on connectors at back of light switch and fuse box.

3. Have vehicle started by pushing and take it to nearest Authorized VW Dealer.

4. Check for loose connections at coil, distributor and spark plugs.

5. Turn on ignition. Remove thin black cable from ignition

**PROBLEM****PROBABLE CAUSE****WHAT TO DO**

coil, hold it by insulation and strike it against blower housing or other ground, **being careful of gasoline and its fumes.**

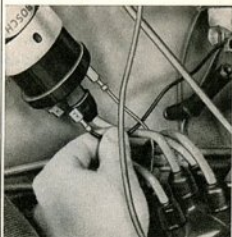

If no spark, electricity does not reach coil from battery. Check push-on connectors under dashboard for tightness, and connectors at fuse box. If still no spark see the nearest Authorized VW Dealer.

6. If spark at black coil cable, trouble is in ignition system.

6. Check in this sequence:

A. Turn on ignition, remove distributor cap, engage 4th gear and push vehicle until ignition points are closed. Open and close ignition points several times with a non-metal object. A visible and audible spark will appear between the points.

If this is not the case, the cables on ignition coil and distributor should be checked for tightness. Clean and adjust distributor points (page 38 and 39). If even then no spark is visible, see your nearest Authorized VW Dealer.

**PROBLEM****PROBABLE CAUSE****WHAT TO DO**

- B. If spark appears at points, remove high tension wire from center of distributor cap and hold it against a metal part of the engine at a distance of approximately  $\frac{1}{4}$ ". Switch on ignition and turn over engine or open ignition points as described under A. A strong blue spark must appear. If this is not the case, see your Authorized VW Dealer.
- C. If a spark appears at high tension cable, the distributor cap should be cleaned inside and outside. Reconnect high tension cable. Remove all spark plugs (page 56). If plugs are clean and dry, reconnect ignition cables to spark plugs and bring spark plugs in connection with metal (ground). **Hold cable with dry piece of cloth to avoid shock.** A spark should appear between spark plug electrodes when the engine is turned over. If not, clean and dry ignition cables and spark plug connectors and check that ignition cables are tight in distributor cap and plug connectors. See your Authorized VW Dealer if the above steps did not ensure proper ignition.
- D. Dirty or wet spark plugs should be cleaned and dried. Install new plugs if necessary. Unburned gasoline on plug electrodes points to excessive fuel supply.

PROBLEM	PROBABLE CAUSE	WHAT TO DO
Engine stalls shortly after starting	<p>7. If spark is fairly good at plugs, trouble is most likely in fuel system.</p> <p>A. Caused by improper starting procedure. If the gas pedal is depressed too often, the accelerator pump of the carburetor injects too much gasoline.</p> <p>B. Carburetor may be flooded, float or needle valve may be sticking.</p>	<p>7. Check fuel system in the following sequence:</p> <p>A. Depress gas pedal completely and operate starter for a prolonged period. If engine does not start, remove and dry spark plugs, turn over engine with plugs removed for approximately 30 seconds. Reinstall plugs and start engine as described on page 16.</p> <p>B. Tap around outside of carburetor with wooden or plastic tool handle. Wait a few minutes and try starting again as described at 7 A.</p>
	<p>8. Poor fuel supply.</p> <p>9. Automatic choke does not open, excessive fuel supply.</p>	<p>8. See paragraph 11 through 13.</p> <p>9. Remove intake elbow from carburetor. Check whether choke valve is in vertical position after ignition has been switched on for 2—5 minutes (depending on outside temperature). The cover for choke unit must be hot. If choke valve is binding in a closed position, contact your nearest Authorized VW Dealer.</p>
Engine stalls while vehicle is driven	<p>10. Defect in ignition system</p>	<p>10. See paragraph 4 through 6.</p>
	<p>11. Fuel supply is exhausted</p> <p>12. Fuel filter in pump may be clogged</p>	<p>11. Check whether any gasoline is left in tank.</p> <p>12. Disconnect intake fuel line from fuel pump and plug up line. After removing the pump cover, the fuel filter can be taken out for cleaning (see page 53).</p>

PROBLEM	PROBABLE CAUSE	WHAT TO DO
Green warning light comes on while you are driving	13. Gasoline may be contaminated by water, dust or dirt.	13. See your VW dealer for cleaning of all components of the fuel system.
Red warning light comes on while you are driving	14. If green light goes on, the oil pressure is too low.	14. Stop at once and check oil level. Add oil as necessary. If the oil level is sufficient and green light goes on during driving, contact the nearest Authorized VW Dealer before driving on.
Red warning light comes on while you are driving	15. If red light goes on, V belt may be torn.	15. Do not continue driving because engine cooling fan is no longer working. Fit spare belt (see page 52).
Red warning light comes on while you are driving	16. Generator does not charge	16. Switch off all unnecessary electrical equipment (radio, etc.). Drive to nearest VW dealer as otherwise the battery will soon get run down.

## How to change the wheels

While changing a flat is never a pleasant job, it will be somewhat easier and safer if you follow these instructions. Remember, if you are changing a wheel at the roadside be sure to turn on your Safety Flasher lights.

The spare wheel is stowed in the cab behind the bench seat and is secured with a retaining bracket and wing nut. To take the wheel out, just tip the seat forwards.

1. Set the hand brake securely and chock the wheels on the opposite side of the one to be removed to prevent the vehicle from shifting off the jack.



2. Insert jack into the square jacking port nearest to the flat tire, and turn the hexagonal nut until the base of the jack touches the ground.



7. When reinstalling the spare, operate the jack until the five holes in the wheel are nearly lined up with the holes in the brake drum.



3. Remove hub cap with hub cap removal tool.
4. Loosen wheel bolts with the socket wrench while the wheel is still on the ground.
5. Raise vehicle until tire clears ground.
6. Remove wheel bolts and take off wheel.

8. First, insert one wheel bolt only. Tighten it enough to allow the wheel to be swung around this point by hand, until the remaining holes in the wheel and brake drum coincide.
9. Insert and tighten the remaining bolts until the self-aligning heads of the five bolts are centered in the corresponding recesses of the wheel.
10. Tighten every other wheel bolt in turn.
11. Lower the vehicle. To release jack insert handle into socket on side of jack and depress, forcing downward on trigger. Remove the jack and make sure that all bolts are tight.
12. Replace the hub cap firmly and make sure it is secure. Remove chocks.

# How to push it and how to pull it

**Pushing (to start).** Turn the ignition key to the ON position, with the gears in neutral. After the pushing vehicle has left the Volkswagen free rolling and the VW has reached a speed between 15 and 20 mph shift into third gear and slowly let out the clutch. Never attempt to start your Volkswagen by towing it with another car.

**Towing.** Place your Volkswagen in neutral (be sure hand brake is released) when it is being towed. Normally the vehicle should be towed forward with the tow chain or rope attached securely to the front torsion bar tubes. If the front wheels are lifted off the ground, as by a tow truck, attach rope to the torsion bar tubes and then wrap once around the front bumper.

If the transmission is damaged, your Volkswagen will have to be towed backwards with the rear wheels off the ground. Attach tow rope to the rear torsion bar tubes, then wrap once around the rear bumper. Since the front wheels will be on the ground be sure to secure the steering wheel tightly with the wheels in a straight-ahead position.

**Rocking (to free).** If your Volkswagen should ever become stuck in snow or mud you may be able to free it by rocking the vehicle back and forth. Rock it as far rearward as you can, then hold it there by rapidly applying the hand brake. Shift into third and take the vehicle as far forward as you can.

Repeat this back and forth movement as long as it seems feasible. If your Volkswagen has a tendency to move either in a forward or rearward direction (should you be stuck on an incline) it will be best to rock the vehicle only in third gear or reverse.

These are your tickets for many thou

- 5 - Valve clearance.
- 6 - Clutch pedal free-play.
- 7 - Tie rods, and dust seals on tie rods and steering ball joints.
- 8 - Tire pressures, tightness of wheel bolts.
- 9 - Brake system for damage and leaks, fluid in reservoir, foot and hand adjustment.
- 10 - Operation of electrical system, headlight adjustment.

**THE SERVICE ADVISER (Quality Control)**

**During roadtest:**

Efficiency of braking, steering, heating and ventilation systems. Overall performance.

**After roadtest:**

Cylinder head covers for leaks. Idling adjustment.

WS 5

## Oil Change 3,000 miles

Having the oil changed and the other minor services listed on the back of this coupon performed at this time at an Authorized Volkswagen Dealership assures you of the best preventive maintenance for your vehicle at the lowest possible cost.



# sands of carefree miles

**Oil Change 3,000 miles**  
and Maintenance Service **6,000 miles**

**Oil Change 3,000 miles**  
and Maintenance Service **12,000 miles**

**Oil Change 15,000 miles**  
and Maintenance Service **18,000 miles**

**Oil Change 21,000 miles**  
and Maintenance Service **24,000 miles**

**Oil Change 27,000 miles**  
and Maintenance Service **30,000 miles**

**Repack front wheel bearings 30,000 miles**

The Service Booklet contains more than just numbered tickets. It contains a plan to keep your Volkswagen troublefree, operating economically and maintaining its high resale value. The coupons will tell you when to have your car lubricated, the oil changed, and when it's time for a regular check-up. And the stubs become a documented record of the excellent care your VW has received. To introduce you to VW Preventive Maintenance we have made the first coupon "on the house" — your vehicle gets a free check-up at 300 miles.

There is, throughout the United States and Canada and 130 foreign countries, an extensive network of Authorized VW Dealers, staffed with well-trained and experienced men, and supplied with all the special tools and equipment required to service your vehicle properly. If you should ever need service when you are away from home, look for the well-known Service Sign. The workshop displaying this sign is your assurance of the same expert, prompt, and courteous service you are accustomed to receiving at home. In case you can't get to an Authorized VW Dealer in time, we are giving you some information which, if needed, will help you to carry out normal maintenance work. However, difficult repair jobs which are beyond your experience should be performed by the nearest VW Dealer. There your Volkswagen will be given expert treatment by those familiar with such jobs.

This will save you time, inconvenience and money.

# Lubrication service

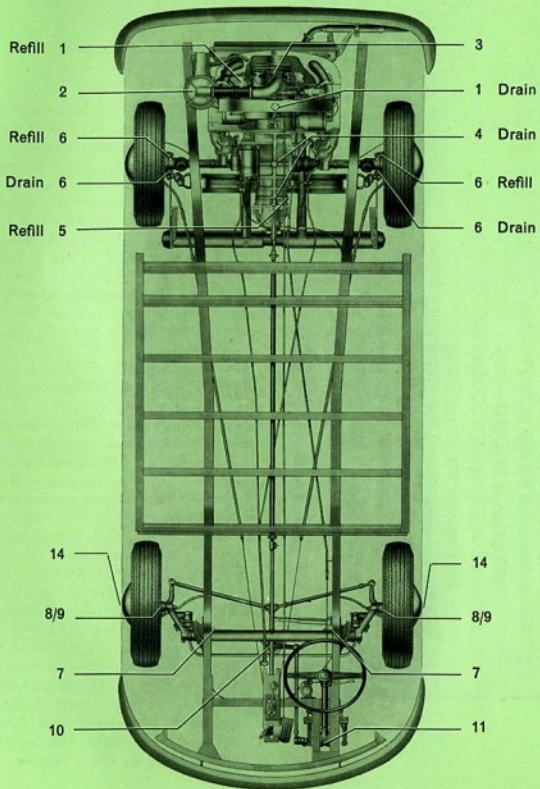

# Lubrication Chart

Initial Lubrication		Subsequent Lubrication			Reference	Lubrication Points
At 500	At 3,000	Every 3,000	Every 6,000	Every 30,000		
x	x	x			1* M	Engine: Change oil, clean oil strainer. Check for leaks
			x		2 M	Check air cleaner, clean lower part if necessary
	x	x			3 M	Lubricate carburetor linkage
			x		5 G	Transmission: Check oil level. Check for leaks
x				x	4/5 G	Transmission: Change oil, clean magnetic drain plugs. Check for leaks
x				x	6 G	Reduction gears: Change oil
x	x	x			7* W	Front axle tubes: Lubricate fittings
x	x	x			8* W	King pins: Lubricate fittings
x	x	x			9* W	Link pins: Lubricate fittings
x	x	x			10* W	Swing lever shaft: Lubricate fitting
	x	x			11 G	Steering gear: Check for leaks
	x	x			12* M	Lubricate door and hood locks and hinges
	x	x			13 W	Check battery, clean and grease terminals
				x	14 W	Clean, grease and adjust front wheel bearings

\*) Every 3 months if the vehicle is driven less than 3,000 miles in 3 months.

## Lubricants

Lubricant	Lubrication Points	Specification
Engine oil HD for "Service MS"	Engine, oil bath air cleaner, carburetor linkage, door hinges	M SAE 30 above 32° F
		M SAE 10 W below 32° F
		M SAE 5 W below -13° F
Transmission oil hypoid	Transmission, reduction gear cases	G SAE 90 all the year*)
	Steering gear case	G SAE 90
Lithium Grease	Torsion bars, king pins, link pins, swing lever shaft, door and hood locks, front wheel bearings, breaker arm fiber block	W Multi-purpose

\*) SAE 80 all the year in countries with arctic climates

### 1. Engine: Change oil, clean oil strainer

Regular oil changes are necessary even if the very best branded oils are used. Diluted and dirty oil in your engine means greater strain and shorter life for your engine. On the other hand, provided that HD oil (for service MS) is used and your Volkswagen is driven under normal conditions, it is unnecessary and uneconomical to change the oil more frequently than called for in the lubrication chart.

The engine oil level should be checked at regular intervals.

The oil level can only be checked with the engine shut off. The oil level is satisfactory when it is between the two marks on the oil level dipstick, but **it should never be permitted to drop below the lower mark.** To make an accurate check, it is best to wipe the dipstick with a clean rag beforehand.

Select an HD oil (for Service MS) of a well-known and dependable brand right at the beginning, and stick to it. Further hints regarding engine oil changes are given in the section "Ice and snow ... you will go" on page 25.

The oil is drained, when warm, by removing the plug in the oil strainer bottom plate. Flushing of the engine is unnecessary, but the oil strainer should be removed and cleaned at every oil change. The two gaskets must be renewed each time.



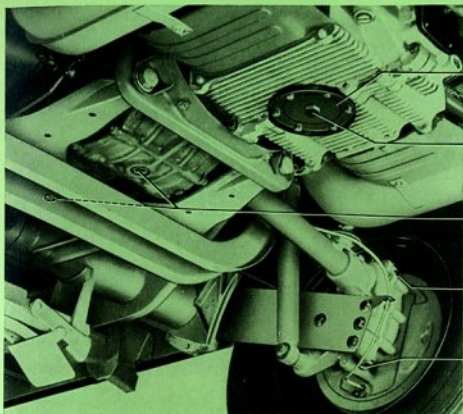

**Oil Strainer**  
with cover

**Oil Drain Plug**  
for crankcase

**Magnetic Oil  
Drain Plugs**  
for rear axle and  
transmission

**Oil Filler Plug**

**Oil Drain Plug**  
for reduction gears  
at rear wheels

The engine is refilled with  
5½ pints of HD oil

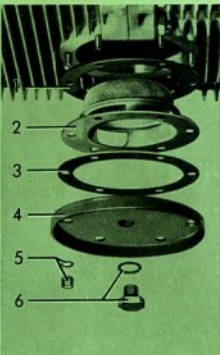

- 1 — Gasket
- 2 — Oil strainer
- 3 — Gasket
- 4 — Bottom plate
- 5 — Cap nut with  
sealing  
washer
- 6 — Drain plug  
with washer

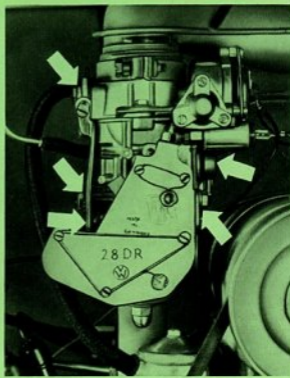
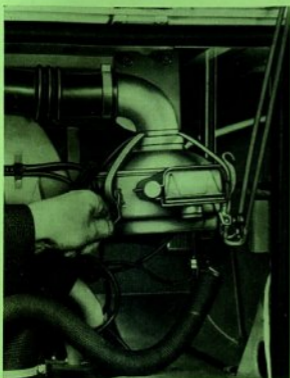

## 2. Checking Air Cleaner

The oil bath air cleaner should be checked every 6000 miles.

All the dust present in the air drawn in by the engine is retained by the filter insert in the upper part of the air cleaner and washed out when the vehicle is in motion by the oil in the lower part of the cleaner. In time, this causes a layer of sludge to form at the bottom of the lower part. If the cleaner check reveals that there is only .16—.2" of oil above the sludge layer, the lower part should be carefully cleaned and filled with fresh oil. The top part does not need cleaning. However, if the filter insert has become so dirty due to overdue cleaning or oil shortage that the air inlet holes on the underside are partly blocked, the encrusted dirt should be removed, preferably with a small piece of wood.

A dirty filter insert not only reduces the engine output, it can also cause premature wear in the engine. If the local conditions are such that the vehicle is

frequently driven over very dusty roads it is advisable to clean the air cleaner more often.

The warm air control flap in the intake elbow should be checked each time for freedom of movement. This flap regulates the flow of warm air to the carburetor in conjunction with the speed of the engine.

### Servicing Air Cleaner

Pull crankcase breather hose off air cleaner.

Pull warm air hose off air cleaner intake elbow.

Take air cleaner off intake elbow and disassemble.

Never lay the upper part down with the filter element upwards.

Clean the lower part thoroughly and fill to the mark with fresh SAE20 engine oil.

When installing the air cleaner, ensure that it fits properly on the intake elbow.

## 3. Carburetor linkage: lubricate

Oil all joints in carburetor linkage.



Draining oil

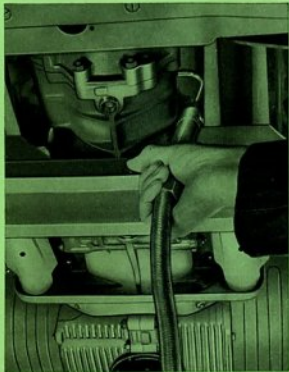

Putting oil in

#### 4. Transmission: check oil level

The transmission and differential gears are combined in the transmission case and share a common supply of hypoid oil. The oil level in the transmission case should be checked every 6000 miles and the rear axle checked for leaks at the same time.

#### 5. Transmission: change oil, clean magnetic drain plugs

During the oil changes at 300 miles and then again at 30,000 miles, the oil is drained when warm by removing both magnetic oil drain plugs. The plugs should be cleaned thoroughly before being replaced.

When the old oil has been drained, the transmission case is refilled with 5 $\frac{1}{2}$  pints of hypoid oil. Wait a few minutes until oil has settled then fill to capacity. The oil should be level with the edge of the filter hole.

**Additives** should not be mixed with hypoid oils.



#### **6. Reduction Gears: change oil**

Each reduction gear case should be drained and refilled with  $\frac{1}{2}$  pint of the same oil which is used in the transmission oil change, and should be performed at the same intervals.

#### **7. Front Axle Tubes: lubricate fittings**

The four fittings of the axle bearing points can be greased properly only if the front axle is raised so that the vehicle weight is taken of the wheels.

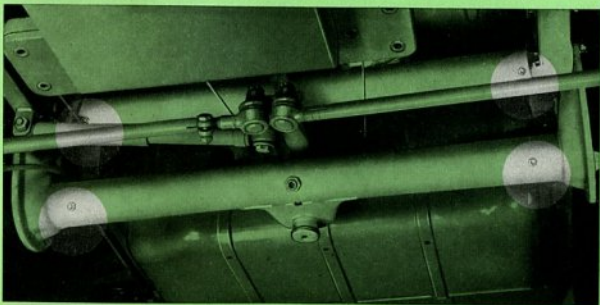





#### **8/9. King Pins and Link Pins: lubricate fittings**

The fittings on king pins and link pins should be greased every 3000 miles.

If the vehicle is frequently driven over bad roads it is advisable to grease the king pins in between the normal lubrication services, i.e. every 1500 miles. Before greasing, the nipples should be wiped clean to prevent dirt from being forced into the bearings. Do not allow grease to get on the brake hoses or tires, as grease and oil will corrode rubber. Even small amounts should be removed immediately.

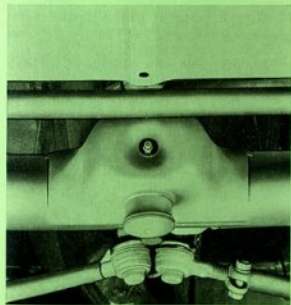

#### **10. Swing Lever Shaft: lubricate fittings**

Proper lubrication of the swing lever shaft is essential to steering ease and safety.



### **11. Steering Gear: check oil level**

The steering assembly should be lubricated exclusively with SAE 90 hypoid oil and under no circumstances with grease or any other oil. The level of the oil in the steering case should be kept at the lower edge of the filler plug hole.

Every 3,000 miles, the steering gear should be checked for leaks.



### **12. Door and Hood locks and Hinges: lubricate**

Apply a few drops of oil to the lid hinges. The door hinges should be oiled at every lubrication service.

Door cylinder locks should be treated with graphite. Dip the key into the graphite, insert key and move it back and forth several times.

### **13. Check battery: Clean and grease terminals**

Clean terminals and outside of battery with a cloth, or if badly corroded, use bicarbonate of soda, being careful not to get any inside the battery. Coat the clean posts and terminals with light grease to prevent corrosion. Then tighten securely and make sure that there is a proper connection to ground.

#### 14. Front Wheel Bearings: repack

Front wheel bearings are packed with grease at the factory. The caps on the front wheel spindles should be free of grease after repacking.

The front wheel bearings are to be cleaned and repacked with grease every 30,000 miles. The brake drums must be removed for this purpose. The bearings must be adjusted after repacking. It is recommended that this job be performed only by your Authorized VW Dealer.

#### Driver's Seat

The upper and lower surfaces of the runners for the driver's seat should be greased lightly to ensure the desired freedom of movement. The runners should be cleaned with a rag before the grease is applied.

#### What lubricants should be used?

It is left to your discretion to select an oil of a well-known and dependable brand of the proper viscosity to suit your seasonal and driving requirements. In cases of doubt, refer to your authorized VW Dealer who will be glad to help you with your lubrication problems. It is recommended that you select "your" brand and type of oil right at the beginning and stick to it at all future oil changes.

The requirements of the VW engine are met by all commercial brand HD oils. Viscosity of the lubricant is an indication of its resistance to flow at a given temperature. The SAE numbers classify lubricants in terms of viscosity, for example: SAE 20 W, SAE 10 W etc. Outside air temperature is decisive for the selection of the SAE grade to be used.

**SAE 30** is suitable for all temperatures above 32° F.

**SAE 10 W** should be used in the winter when it is expected that the temperature will fall below 32° F.

**SAE 5 W** is used only in arctic climates, where the temperature falls below -13° F.

**CAUTION:** Avoid sustained speeds above 55 mph when using SAE 5 W oil.

Where the API (American Petroleum Institute) Classification applies the HD oils suitable for the VW engine are referred to as "For Service MS".

**Additives** should not be mixed with HD oils.

For additional information on the proper lubricants to use during cold weather see page 25.

# These vouchers guarantee you a complete maintenance job

W 10

## **Lubrication and Maintenance Service 6,000 miles**

Having the Lubrication and Maintenance Services listed on the back of this coupon performed at this time at an Authorized Volkswagen Dealership assures you of the best possible preventive maintenance for your vehicle at the lowest possible cost.

Lubrication  
and Maintenance Service **6,000 miles**

# Maintenance Chart

At 300	At 6,000	Every 6,000	
x	x	x	Check fan belt
x	x	x	Clean fuel pump filter
x	x	x	Check contact points and replace if necessary. Lubricate distributor. Adjust contact breaker gap and ignition timing
x	x	x	Adjust valve clearance and check cylinder covers for leaks
	x	x	Clean spark plugs. Check compression
	x	x	Check exhaust system for damage. Check rubber valve for crankcase ventilation
x	x	x	Adjust clutch pedal free-play
x			Check rear axle shaft nuts
	x	x	Steering gear: Check and adjust play between peg and worm
x	x	x	Check tie rods, dust seals on tie rod and ends steering ball joints
	x	x	Check and adjust torsion arm link pins and toe-in
x			Check tire pressures and tightness of wheel bolts
	x	x	Check tire pressures, wear and damage
x	x	x	Check brake system for damage and leaks. Check brake fluid in reservoir. Adjust foot and hand brakes
	x	x	Check thickness of brake linings through inspection hole
x	x	x	Check operation of electrical system. Adjust head lights
x	x	x	Check efficiency of braking, steering, heating and ventilation systems
x	x	x	Adjust idling

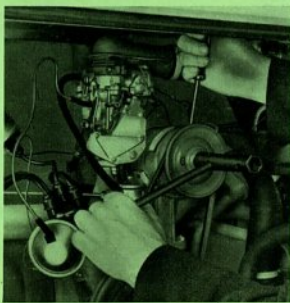
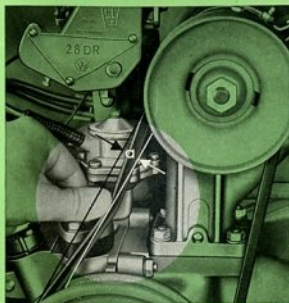

## 1. Check and adjust fan belt

**Checking tension.** The V-belt drives the generator and the fan. **Perfect condition and correct tension ensure long belt life and adequate engine cooling.** Checking is very simple: when pressed with the finger the belt should give between  $\frac{1}{2}$  and  $\frac{3}{4}$  inch (dimension a).

If you find any sign of wear, such as frayed edges, see your Authorized VW Dealer. In spite of its long life there should always be a spare belt in the vehicle.

### **Adjusting and replacing the Fan Belt.**

To adjust or replace the fan belt, remove nut and outer half of generator pulley. When loosening or tightening nut, insert a screwdriver in the slot in the inner half of the pulley and support it against the upper generator housing bolt. The adjustment of the fan belt tension is effected by means of spacer washers situated between the two pulley halves. Belt slackness is taken up by removing one or more washers. If the belt is too taut,

one or more washers should be added. Store extra adjustment washers on the shaft between nut and outer pulley half.

The fan belt should not be too slack, nor should it be too tight. Newly installed belts will stretch to some extent and should, therefore, be checked and adjusted at 300 miles. Further adjustment is not necessary as the tension will not change.

Always keep a new fan belt in the vehicle.





## 2. Clean Fuel Pump Filter

The fuel pump filter prevents foreign matter and dirt from entering the carburetor.

The filter should be cleaned at the prescribed intervals.

1. Install clip on fuel hose between tank and engine compartment.
2. Remove fuel pump cover screw and take off cover.
3. Remove filter and wash in solvent. (When installing the filter do not forget the gasket for the cover.)

## 3. Ignition Timing

Particular attention must be paid to correct ignition timing. In many cases poor performance, high fuel consumption and even damage to the engine can be the result of incorrect ignition setting. The ignition must not be advanced arbitrarily under any circumstances.

Before setting the ignition timing, the breaker contact point gap must be checked. The ignition timing must be set to  $7.5^\circ$  before TDC when the engine is cold.

### Clean Contact Points

A certain amount of material movement takes place between the contact breaker points in the course of time. This creates a small point and a crater on the contact surfaces of the breaker points but does not normally affect the ignition. It is important, however, that the points are always clean and free of oil and grease. The best way to clean the points is to draw a piece of cardboard between them while pressing them lightly together. Badly burned contacts should be renewed.

### Lubricating Ignition Distributor

The breaker arm fiber block in the ignition distributor should always be lubricated with Lithium grease. Every 6,000 miles check whether this location must be cleaned and provided with new grease. Only a very small amount of grease should be used and none of it must come in contact with the breaker points as otherwise the ignition will be affected. Every 6,000 miles, one drop of oil must be applied to the breaker base plate felt ring.

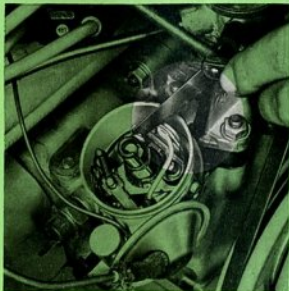

### Adjust Point Gap

Remove distributor cap and rotor. Turn engine until the breaker arm is fully lifted by a cam lobe.

Loosen breaker point screw.

Place a screwdriver between the two lugs on the breaker plate and the slot in the fixed point and adjust points gap to .016". Tighten screw and install rotor.

After adjusting contacts, adjust the ignition timing.

### Adjust Ignition Timing

Turn the engine clockwise until the right hand mark on the crankshaft pulley (10° before top dead center) is aligned with the crankcase joint and the rotor arm is pointing to the Number 1 cylinder mark on the edge of the distributor housing.

Loosen distributor bracket clamp bolt. Connect one lead of 6 volt test lamp to the primary terminal on the distributor and the other to ground.

Switch on ignition.

Turn distributor clockwise until the points are closed and then turn counter-clock-

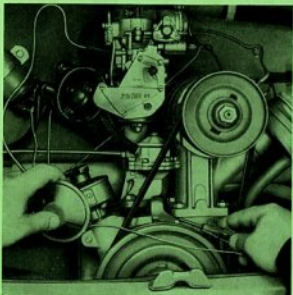

wise slowly until the points just begin to open and the test lamp lights up.

Tighten clamp bolt.

The timing is correct if the test lamp lights up at the moment the right hand mark aligns with the crankcase joint when the engine is turned slowly clockwise. The engine should be turned back about 1/2 turn beforehand to take up the play in the distributor drive.



#### 4. Adjust Valve Clearance

The valves should be adjusted only when the engine is cold. The valve clearance is .004" for the inlet valves and exhaust valves.

To ensure that the valves are fully closed when adjusting, the piston concerned must be at TDC on the compression stroke. The cylinder arrangement is shown by the embossed number on the engine cover plates. The adjusting sequence is 1, 2, 3, 4.

Remove distributor cap.

Turn engine until the right hand mark on the crankshaft pulley is aligned with the crankshaft joint and the rotor arm points to the Number 1 cylinder mark on the edge of the distributor housing.



Remove cylinder head covers.

Loosen lock nuts of adjusting screws for valves of Number 1 cylinder.

Adjust clearance to .004" with the feeler gauge.

Hold clearance screws and tighten lock nuts.

To adjust valves on cylinders 2, 3, and 4, turn the engine counter-clockwise until rotor has moved 90° for each cylinder.

After making the adjustment, ensure that the cylinder head cover gaskets are not leaking.

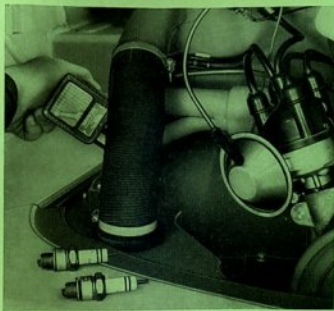

## 5. Check Compression

The compression is checked by inserting a suitable gauge into the spark plug hole when the engine is warm. All the spark plugs should be removed. The accelerator pedal is then depressed fully and the engine turned over with the starter until the gauge reading shows no further change.

The pressure should be at least 100 psi. It is important that only a good accurate instrument is used and a good seal obtained between instrument and spark plug seat.

## ... Clean and Gap Spark Plugs

Remove the spark plugs and check their exterior. The appearance of electrodes and insulators provides considerable information on engine adjustment and condition.

Electrodes and insulator

- |             |  |
|-------------|--|
| medium grey | — good adjustment of carburetor and correct performance of spark plug, |
| black       | — mixture too rich,  |
| light grey  | — mixture too lean,  |
| oiled up    | — misfiring or piston ring blow-by.                                    |



(a) = .028"

Cleaning spark plugs is best accomplished with a spark plug cleaning machine. If none is available you should wire-brush the electrode end of the plug and blow it out with an air hose. The rest of the plug should be wiped with a clean cloth and solvent. The insulator should be clean and dry on the outside in order to avoid short circuits or tracking. Check the electrode gap (.028") and reset if necessary by bending the outer electrode. Use gasket when installing the plugs.

Generally speaking you may count on a spark plug service life of up to 12,000 miles.

## 6. Check Exhaust Systems for Damage

The entire length and all connections of the exhaust system should be visually checked even for the tiniest pin-hole. One method of checking the exhaust system is to cover the ends of both exhaust pipes and turn on engine. If the system is functioning properly the engine should stall.

Because of the possibility of escaping carbon monoxide fumes this important check should be made by an Authorized VW Dealer.

## 7. Adjust Clutch Pedal Free-Play

Easy gear shifting and complete transmission of engine output to gears and wheels can only be guaranteed if the clutch is adjusted as specified.



Measured at the clutch pedal this free play should be  $\frac{1}{2}$ " to  $\frac{3}{4}$ " (a). The clearance can be adjusted with the wing nut at the rear end of the cable.

Ensure that the two lugs in the wing nut engage in the slots in the clutch operating lever. Depress clutch pedal several times and then check play again.

Lubricate bearing surface between lever and adjusting nut with universal grease.

## **8. Check Rear Axle Shaft Nuts**

The checking of the rear axle shaft nuts is only carried out once at 300 miles and should be done by a VW Service Station.

## **9. Adjust Steering**

In the straight-ahead position there should be no steering wheel play and the front wheels should resume their straight-ahead position after the vehicle has taken a turn. All steering adjustments should be performed only by an Authorized VW Dealer.

## **10. Check Dust Seals on Tie Rod Ends**

Check the dust seals of the maintenance-free tie rod ends for damage at every lubrication. Damaged seals should be renewed as soon as possible.

## **11. Check and Adjust: Torsion Arm Link Pins**

The torsion arm link pins should be checked and, if necessary, re-adjusted every 6,000 miles. The front end of the vehicle should be raised so that the weight is taken off the wheels.

### **Checking**

Rock the wheel by hand to check for end play between torsion arm link and torsion arms. If play is present, adjust torsion arm link pins.

## Adjusting

1. First grease torsion arm link pins thoroughly.
2. Back off pinch bolts at torsion arm eyes.
3. Fully tighten link pins first, then back off about  $\frac{1}{8}$  of a turn.



4. Tighten the torsion arm link pins until the resistance of the shoulder making contact can be felt.
5. Tighten the pinch bolts again.

If the range of adjustment is insufficient, the shims are worn and should be replaced by an Authorized VW Dealer. After pins have been adjusted, it is absolutely necessary to check the toe-in.

## ...Toe-in

With the empty vehicle on the ground, front wheel toe-in should be  $0^{\circ} \pm .04^{\circ}$  and with maximum permissible gross weight it should be  $.08^{\circ}$  to  $.20^{\circ}$ . These dimensions can be accurately checked only with a track tester at an Authorized VW Dealer. Fractional deviations can wear the tires quickly and reduce road holding qualities.

## 12. Check Tire Pressure and Wheel Bolts for Tightness

Recommended inflation pressure for tires is as follows:

front tires	— 28 lbs./sq. in.
rear up to $\frac{3}{4}$ payload	— 33 lbs./sq. in.
with full load	— 40 lbs./sq. in.
spare	— 40 lbs./sq. in.



## 13. Check Brake System for Damage and Leaks

Even barely visible leaks in the hydraulic system will be reflected in brake pedal play. If play is excessive the brake lining wear should be visually checked through the inspection hole in the brake drum. If the 6,000 mile maintenance shows that the linings are badly worn (a thickness below .090"), the brakes must be relined. Relining should be done by your Authorized VW Dealer.

All brake lines and unions should be checked for leakage, damage and corrosion. Damaged lines should be renewed immediately.

### ... Adjust Foot Brakes

If brake pedal play is found to be excessive, and visual inspection indicates that the linings are not badly worn, the brakes should be adjusted. You should then proceed as follows:

1. Remove hub caps.
2. Jack up the vehicle and turn the wheel to be adjusted until the hole in the brake drum is in line with one of the adjusting nuts.
3. Insert a screwdriver through the hole and turn the adjusting nut in the direction indicated by the arrows until a light drag is noted when the wheel is turned by hand.
4. Repeat procedure on the other adjusting nut. Note that the two nuts turn in opposite directions.
5. Back off the adjusting nuts by 3 to 4 teeth until the wheel turns freely.
6. Repeat the above operations on the other wheels.
7. Replace hub caps securely.

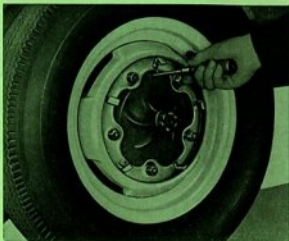

When adjusting the rear wheel brakes, the hand brake must be released. It is advisable to depress the brake pedal sharply before and after adjusting the brake shoes to ensure brake shoe centering, i.e. the proper position of the shoes relative to the brake drum.

### ...Adjust Hand Brake

Always adjust the foot brake before checking or adjusting the hand brake. The hand brake needs adjustment if the Volkswagen's rear wheels are not locked when the hand brake lever is in the fourth ratchet notch.

1. Jack up both rear wheels.
2. Push hand brake boot upwards.
3. Tighten adjusting nuts of the brake cables to a degree which will still allow the rear wheels to turn freely when the hand brake is released.
4. Pull up hand lever two notches and make sure both rear wheels have the same braking effect. At the fourth notch it should be impossible to turn the wheels by hand. Lock adjusting and counter nuts. Push brake boot back in place.



### ... Check Brake Fluid in Reservoir

The brake fluid reservoir should be at least  $\frac{3}{4}$  full.

The reservoir is accessible after lifting the inspection plate in the floor of the cab.





#### **14. Check Acid Level and Specific Gravity of Battery; Clean and Grease Terminals**

The battery should be checked with a cell tester. This is a voltmeter in parallel with a heavy resistance. The voltage of each cell should not fall below 1.6 volts while taking the reading (10—15 seconds). Otherwise the cell is discharged or defective. Under no-load conditions each charged cell should read 2 volts.

Add distilled water to each cell to bring the level just above the plates. The acid level has to be adjusted in accordance with the acid level mark. Losses by evaporation may be replenished by adding distilled water. Never add acid, unless it is known that acid has been spilled from the battery. Check specific gravity afterwards and compensate if necessary.

When storing your vehicle for a prolonged period, it is advisable to take the battery to a workshop for storage. A battery which is not in constant use will discharge itself in time and this can result in permanent damage to the plates if the battery is not checked about every 4 weeks and charged as necessary.

#### **15. Check and Adjust Complete Electrical System**

##### **Check Fuses**

The fuse box, with transparent cover, is located below the parcel shelf. When a fuse has blown out, it is not sufficient merely to replace it with a new one. Inspect the electrical system for evidence of short circuits or other faults which may have caused the fuse to blow. Under no circumstances should you use a fuse patched up with tin foil or wire because this may result in severe damage. We suggest that you carry with you several spare VW fuses.

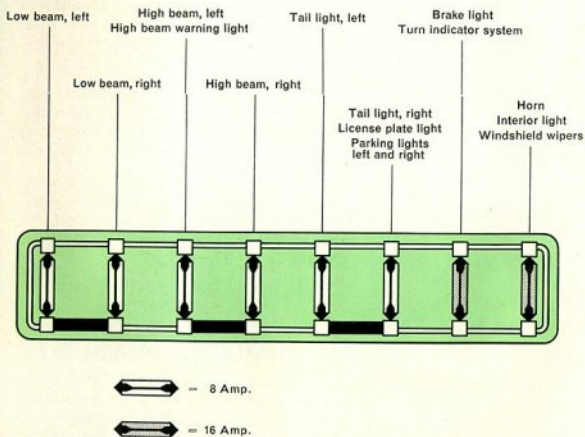
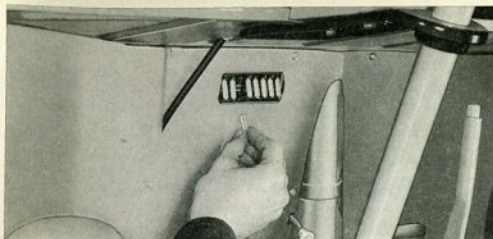

After checking all lights, signals and horn, aim the headlights. It is best to check the headlight alignment on a regulation screen. If no headlight aiming device is available proceed as follows:

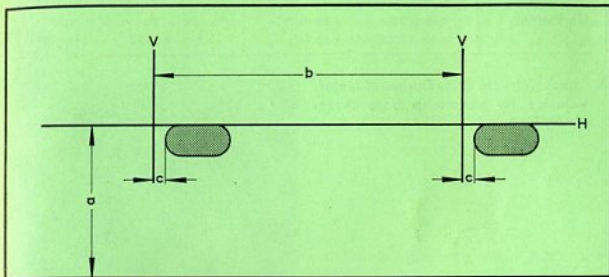

a = Height of headlight centers from ground

b = Distance between headlights =  $39\frac{1}{2}$ "

c = 2"

1. Adjust tires to correct pressures and park vehicle on level surface squarely facing a wall or screen 25 feet in front of the headlights. The driver's seat must be loaded with one person or a weight of 154 lbs.
2. Measure height (a) of center of headlights from ground and draw a horizontal line on screen at this height the full width of the vehicle.
3. Opposite the center of each headlight, draw a vertical line intersecting the horizontal. These lines should be  $39\frac{1}{2}$  inches apart. Drawing a vertical line for the center of the vehicle might help aligning vehicle with screen.
4. Aim the headlights individually by turning the two aiming screws with low beams switched on. Cover up the second headlight.
5. The headlights are correctly aimed when the top edge of the high intensity zone is on the horizontal line H and the left edge is 2" to the right of the vertical line V.

Adjustment	Headlamp: right	left
Vertical	upper screw: clockwise - lowers anti-clockwise - raises	lower screw: clockwise - raises anti-clockwise - lowers
Horizontal	lower screw: clockwise - to right anti-clockwise - to left	upper screw: clockwise - to left anti-clockwise - to right

6. Check with your State Bureau of Motor Vehicles for variations from these dimensions.

#### Replacement of Sealed-Beam units

Loosen the screw in the bottom center of the rim and take out the complete headlight unit. Pull cable connector off the Sealed-Beam unit and disconnect the two cables from the parking light bulb holder.

Remove the five retaining springs and replace the Sealed-Beam unit.

**Caution:** The removal of the springs must be accomplished without using any tools. Hold the unit with one hand and remove the springs with the thumb of the other hand. The use of a screw-driver or of any other instrument to remove the retaining springs may cause a spring to jump out.

The parking light bulb can be replaced after removing the bulb holder.

When installing the headlight, ensure that the Sealed-Beam unit and the sealing ring between lamp and fender are located correctly.





#### **Replacing Front Turn Indicator Bulb.**

Remove two Philips screws and take off lens and rubber gasket. Press bulb lightly into holder, turn and remove. Replace bulb. When replacing make sure the gasket is properly seated all around, insert lens and tighten screws evenly, but do not overtighten. Do not touch metal reflector with hands, as this can corrode the surface.

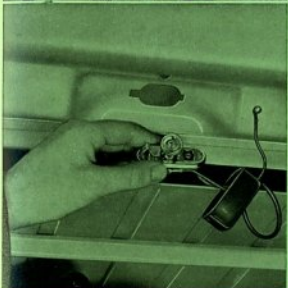

#### **Replacing License Plate Bulb.**

Pull off rubber cap, press spring in holder towards bulb and remove holder. Replace bulb. Make sure that the holder contact springs are clean and that they have sufficient tension for secure bulb contact.

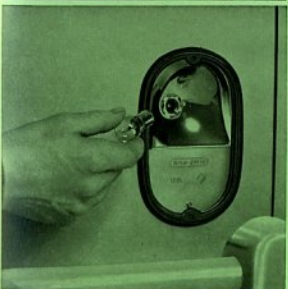

#### **Replacing Rear Turn Indicator Bulb.**

Remove two Philips screws and take off lens and rubber gasket. Press bulb lightly into holder, turn and remove. Insert replacement bulb. As with the front turn indicator, be sure the gasket is properly seated, then replace lens and tighten the screws evenly.

## Replacing Warning Light Bulb

The warning lights for oil pressure, generator charging, flashing indicators, headlight main beam as well as the speedometer and gas gauge lights are accessible from under the instrument panel. The bulb sockets can easily be removed.

## 16. Check Efficiency of Brakes, Steering and Heating System

Note any deficiencies which show up during the road test and make the proper adjustments.

## 17. Adjust Idling

The carburetor is tested at the factory and properly adjusted to the engine. Do not alter this adjustment by exchanging the jets for other than the prescribed sizes. This would be detrimental under normal operating conditions, and many result in hard starting, excessive fuel consumption or unsatisfactory engine performance.

Only the idle setting may require occasional adjustment. Before attempting to adjust the carburetor, make sure the engine is at normal operating temperature.

Also check that the idle adjustment screw is on the lowest step of the fast idle cam in the automatic choke.

1. Turn the idling adjusting screw (1) in or out until normal idling speed is attained (about 700–800 rpm) this speed is reached just as the generator warning light goes out.
2. Gradually turn the volume control screw (2) to the right until the idling speed drops, then back it off a  $\frac{1}{4}$  to  $\frac{1}{3}$  turn to the left.
3. Finally re-adjust the idling speed.

1

2

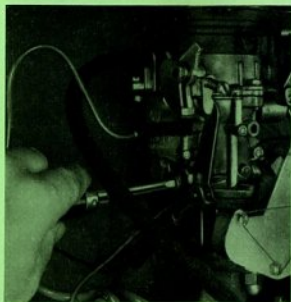
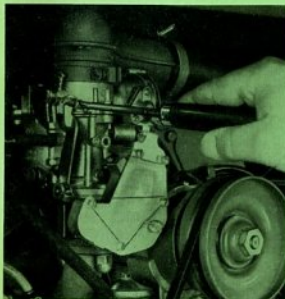

The adjustment is correct if the engine does not stall when the throttle is either suddenly opened or shut with the clutch pedal depressed. Poor idling may also be the result of damaged gaskets, loose intake manifold flanges, faulty ignition or leaky valves. Checking and adjustment of the carburetor, automatic choke and the accelerator pump should be left to an Authorized VW Dealer, who has the experience necessary for such adjustments.

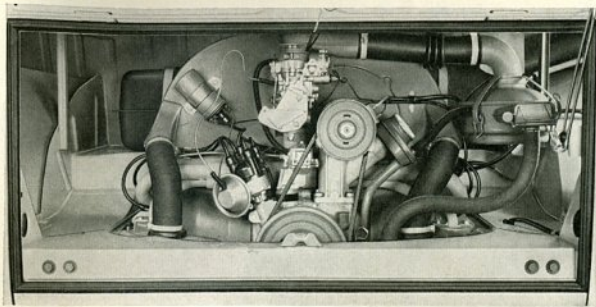

## How your Volkswagen works

### ENGINE

The engine, located in the rear of the vehicle, is attached by 4 bolts to the recessed flange of the rubber-mounted transmission. Two pairs of cylinders are horizontally opposed. Each pair has one common cylinder head made of a light magnesium aluminium alloy. The overhead valves are located in the cylinder head and are operated from the camshaft by means of push rods, cam followers and rocker arms. The short crankshaft runs in four main bearings and has heat treated journals. It drives the camshaft by means of helical gears. The connecting rods are fitted with lead-bronze bearings. The pistons are made of light alloy.

A downdraft carburetor produces the fuel and air mixture to supply the cylinders. The engine is equipped with battery ignition. The spark advance is controlled automatically by a vacuum mechanism.

The oil pump of the full pressure lubrication system is driven by the camshaft and draws the oil from the crankcase through a strainer and pumps it to the various lubrication points via an oil cooler. In cold weather, when the oil is thicker, an oil pressure relief valve makes it possible for the engine to be lubricated directly, that is, by avoiding the oil cooling system.

The air cooling of the engine is done by means of a fan, which is attached to the extended generator shaft and driven by a V-belt. The generator pulley is adjustable to permit adjustment of belt tension. The fan draws in air through an opening in the fan housing, and the air cools the engine by passing through the cylinder fins. A thermostat controls and regulates the amount of cooling air and ensures well-balanced operating temperatures.



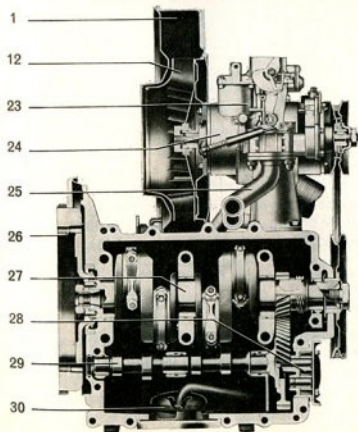
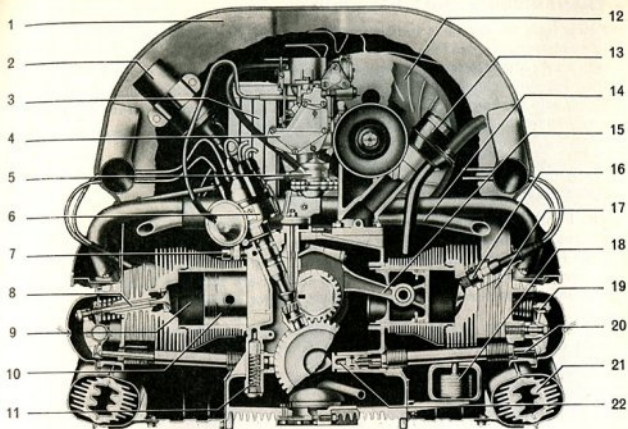

## ENGINE

- 1 - Fan housing
- 2 - Ignition coil
- 3 - Oil cooler
- 4 - Speed limiter
- 5 - Fuel pump
- 6 - Distributor
- 7 - Oil pressure switch
- 8 - Valve
- 9 - Cylinder
- 10 - Piston
- 11 - Oil pressure relief valve
- 12 - Fan
- 13 - Oil filler and breather
- 14 - Pre-heating pipe
- 15 - Connecting rod
- 16 - Spark plug
- 17 - Cylinder head
- 18 - Thermostat
- 19 - Rocker arm
- 20 - Push rod
- 21 - Heat exchanger
- 22 - Cam follower
- 23 - Carburetor
- 24 - Generator
- 25 - Intake manifold
- 26 - Flywheel
- 27 - Crankshaft
- 28 - Oil pump
- 29 - Camshaft
- 30 - Oil strainer

## **TRANSMISSION AND FINAL DRIVE**

Power from the engine is transmitted to the gears via a single-plate dry clutch. The transmission provides four speeds forward and one reverse. All models are equipped with a synchromesh transmission. The gears are helically cut to provide silent operation. The drive pinion and the ring gear of the rear axle are also helical. The two rear swing axle shafts pivot at the differential housing. Spur wheel reduction gears are provided on the outer ends of the rear axle tubes.

## **AXLES AND STEERING**

The front axle consists of two rigidly joined tubes containing the torsion bars and the suspension arms. The front wheels are sprung independently. The suspension arms for parallelograms assuring proper steering and suspension geometry under all driving conditions. Stop with rubber buffers are provided to prevent excessive rebound. A stabilizer is fitted to the lower torsion arms.

The steering gear, which is of a worm and rolling stud type, actuates the steering arms of the independent suspension by a draglink and a divided tie rod.

The rear axle is of the swinging half-axle type. The rear wheels are also independently sprung by means of adjustable round steel torsion bars. Double acting hydraulic shock absorbers of the telescope type in front and rear control wheel movement.

The hydraulic foot brake operates on all four wheels; the hand brake acts only on the rear wheels through cables.

## **BODY**

The body is of a unitized, all-steel design, provided with a strengthening frame to support the axles. The position of the load space within the wheelbase ensures an even distribution of the load on all four wheels. The loading compartment is accessible through a double-wing door from the side and through a hinged rear panel. The tarpaulin of the Pick-up as well as the bows which are fastened to the platform by means of a few screws can easily be removed and replaced. The driver's compartment for 3 persons offers exceptional driving visibility. Ventilation is through vent wings and sliding windows in addition to an overhead fresh air regulator.

## **HEATING**

The air drawn in by the fan is warmed by the heat exchangers. The warm air then passes along a tube in the center of the vehicle into the cab through two adjustable outlets at foot level and two defroster vents at the windshield. On the VW Station Wagons the passenger compartment is also heated by outlets under the rear seat. The heating is regulated by a knob which is operated from the driver's seat.

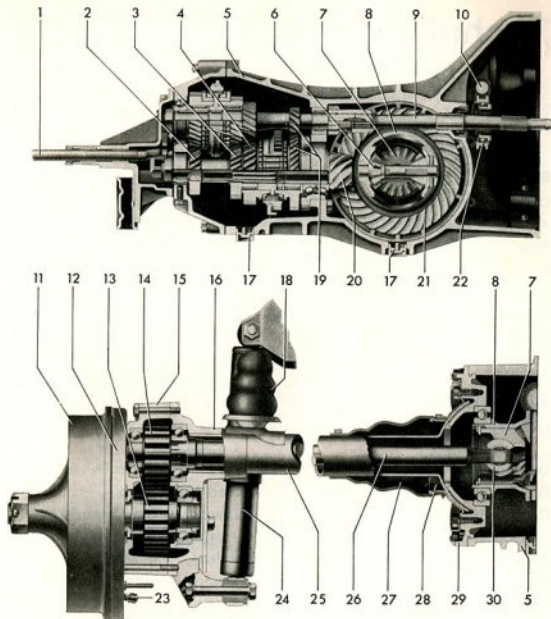

### REAR AXLE AND TRANSMISSION

- |                             |                                      |                                |
|-----------------------------|--------------------------------------|--------------------------------|
| 1 - Selector shaft, inner   | 12 - Brake back plate                | 20 - Drive pinion              |
| 2 - 4th gear                | 13 - Reduction driven gear and shaft | 21 - Ring gear                 |
| 3 - 3rd gear                | 14 - Reduction drive gear            | 22 - Clutch release bearing    |
| 4 - 2nd gear                | 15 - Reduction gear case cover       | 23 - Bleeder valve             |
| 5 - Transmission case       | 16 - Reduction gear case             | 24 - Telescopic shock absorber |
| 6 - Differential pinion     | 17 - Magnetic oil drain plugs        | 25 - Rear axle tube            |
| 7 - Side gear               | 18 - Rubber buffer                   | 26 - Rear axle shaft           |
| 8 - Differential housing    | 19 - 1st gear                        | 27 - Dust sleeve               |
| 9 - Main drive shaft        |                                      | 28 - Rear axle tube retainer   |
| 10 - Clutch operating shaft |                                      | 29 - Final drive cover         |
| 11 - Brake drum             |                                      | 30 - Fulcrum plate             |

# Technical Data

## ENGINE

Design	4 Cylinder, 4 Stroke, in Rear of Vehicle
Arrangement of Cylinders	Horizontally Opposed
Bore	3.27 ins. (83 mm)
Stroke	2.72 ins. (69 mm)
Capacity	91.10 cu. ins. (1493 cc)
Compression Ratio	7.5:1
Valves	O.H. Type
Valve Clearance	Intake .004 ins. } to be adjusted when Exhaust .004 ins. } engine is cold
Brake Horsepower (SAE)	53 bhp at 4200 rpm
Lubrication	Full pressure (Gear Pump with Oil Cooler)
Oil Capacity	5.3 Pints (4.4 Imp. Pints)
Fuel Pump	Mechanical Type
Carburetor	Downdraft Type Solex 30 PICT-1
Cooling System	Air Cooling by Fan, Thermostat controlled
Battery	6 Volts, 77 Ampere Hours
Starter	Electric, 6 Volts, .6 HP
Generator	6 Volts, 180 Watts at 1700 rpm with Voltage Regulator
Ignition Distributor	Vacuum spark advance
Firing Order	1-4-3-2
Spark advance	7.5° before T.D.C.
Breaker Point Gap	.016 ins.
Spark Plugs	14 mm thread Beru 175/14, Bosch W 175 T 1, Champion L 87 y, or other spark plugs of correct heat range
Spark Plug Gap	.028 ins.
Clutch Design	Single Disc, Dry
Clutch Pedal Free-Play	$\frac{3}{4}$ ins.

## TRANSMISSION

4 Synchronized Forward Speeds, 1 Reverse

Gear Ratios

First: 3.80:1

Second: 2.06:1

Third: 1.22:1

Fourth: (Manually operated overdrive):  
0.82:1

Reverse: 3.88:1

## REAR AXLE

Power is transmitted through a helically-cut drive pinion and ring gear, via two swinging axles and spur gear reduction drives to the rear wheels.

Ratio

4.375:1

Refill Oil Capacity of Transmission and  
Rear Axle

5.3 Pints (4.4 Imp. Pints)

## REAR WHEEL REDUCTION GEARS

Ratio

1.26:1

Oil Capacity of Reduction Gear Cases

0.53 Pint (Imp. 0.44 Pint)

## CHASSIS

Suspension, Front

Two Laminated Torsion Bars

Suspension, Rear

Two Solid Torsion Bars

Shock Absorbers

Double-Acting Telescopic Type, Front  
and Rear

Steering

Ross type cam and lever steering gear  
with rolling stud contact and hydraulic  
steering damper

Turns of Steering Wheel, Lock to Lock

2.8

Turning Circle

about 39 Ft.

Foot Brake

Hydraulic, Operating on all 4 Wheels

Hand Brake

Mechanical, Operating on Rear Wheels

Wheels	5 JK × 14, Drop-Center Type
Tires	7.00 — 14 tubeless
Inflation Pressure	Front: 28 lbs./sq. in. Rear: up to $\frac{3}{4}$ payload 33 lbs./sq. in. with full load 40 lbs./sq. in.
Wheel Base	Spare: 40 lbs./sq. in.
Track (Tread)	94.5 ins. Front: 54.1 ins. Rear: 53.5 ins.
Toe-in (Vehicle empty)	0 ± .04 ins.
(Vehicle fully loaded)	.08 — .20 ins.

## DIMENSIONS AND WEIGHTS

	<u>Standard Station Wagon and Kombi</u>	<u>De Luxe Station Wagon</u>
Length	168.5 ins.	169.3 ins.
Width	68.9 ins.	70.9 ins.
Height	75.8" ins.	75.8" ins.
Ground Clearance	7.8" ins.	7.8" ins.

## LOAD SPACE (seats removed)

Mean Length	106.3 ins.
Mean Width	59.1 ins.
Mean Height	53.1 ins.
Mean Capacity	170 cu. ft.

## LUGGAGE COMPARTMENT

Mean Length	27.6 ins.
Mean Width	57.1 ins.
Mean Height	31.5 ins.
Mean Capacity	28 cu. ft.

## WEIGHT IN LBS.

	<u>Payload</u>	<u>Unladen Weight</u>	<u>Gross Vehicle Weight</u>	<u>Max. Seating Capacity</u>
Kombi	2050	2515	4563	8
Standard Station Wagon	2028	2535	4563	8
Deluxe Station Wagon	2028	2535	4563	8

Permissible axle loads in lbs. Front: 2094 Rear: 2315

Performance	65 mph
Climbing ability first speed	28%
second speed	14.5%
third speed	8%
top speed	4.5%

## REFILL REQUIREMENTS

Fuel tank capacity	10.6 gallons (8.8 Imp. Gallons)
Engine	5.3 pints (4.4 Imp. Pints)
Transmission and rear axle	5.3 pints (4.4 Imp. Pints)
Reduction gear cases	0.53 pints each (.44 Imp. Pints)
Steering gear	0.53 pints (.44 Imp. Pints)
Brake system	0.63 pints (.53 Imp. Pints)
Windshield washer container	1 quart (approx.)

Fuel Consumption 25.0 mpg

This is the measured consumption plus 10%, determined with half the permissible payload at a continuous  $\frac{3}{4}$  of maximum speed (53 mph) on level road.

Fuel rating	91 Octane (Res. No.)
Oil Consumption	Approx. 1.7—4.8 pints per 1000 miles (1.4—4.0 Imp. Pints)

## DRIVING LIGHTS

Headlight	No. 6006 Type 2
Front Parking	No. 81
Front Turn and Safety Flasher	No. 1129
Tail, Turn and Stop	No. 1154
License	No. 81

# Index

Accelerating	20	Engine: care in winter	25
Accelerator Pedal	15	description	70
Additives, oil	49	lubrication	42/43
Ash tray	13	number	80B
Axle loads	77	oil level	42
		oil strainer	43
		sectional view	71
		specifications	74
		type of oil	49
Battery: Maintenance	48	Engine compartment door	2
care in winter	24		
Body, description	72		
Brakes: adjusting	59—61		
application	20	Fan belt: checking and adjusting	52
care in winter	24	Foot brake, adjusting	60
checking	59—61	Fresh air regulator	11
description	72		
Carburetor: adjusting	67	Front axle: description	72
type	74	Front wheel bearings: repacking	49
Chains, tire	24	Fuel consumption	77
Chassis, care in winter	24	Fuel pump, filter, cleaning	53
Chassis number	80B	Fuses, replacing	63
Cleaning	27		
Climbing ability	77	Gas gauge	13
Clutch: design	74	Gear shift pattern	18
pedal	15	Generator	70
pedal free-play	57	Ground clearance	76
Controls and instruments	12		
Cold weather hints	24		
Cooling of engine	70	Hand brake: adjusting	61
		description	72
		Headlights: aiming	65
		changing unit	66
Dimmer switch	14	Heater: description	72
Door locks: care in winter	24	operation	15
lubrication	48	Horn button	12



Identification plate	80 B	Seats, removing and reversing	7
Idling, checking and adjusting	67	Shock absorbers, design	75
Ignition: breaker point gap	54	Spark plugs, care of	68, 69
firing order	74	Specifications, general	74
timing	54	Speedometer	13
Jack	36	Speed ranges for shifting	19
Keys	2, 3	Starting	16
License plate light, replacing	66	Steering: adjusting	57
Light switch	12	description	72
Lubrication	40	type	75
Lubrication chart, lubricants	41	Stoplight: bulb replacement	66
Lubrication points	40	Sunroof: cleaning	28
Maintenance chart	51	opening	11
Oil consumption	77	Suspension	75
Oil Level: engine	42	Tires: inflation pressure	59
steering gear	48	Toe-in, adjusting	59
transmission	45	Tool kit	80
Parking	22	Towing	37
Pushing (to start)	37	Track (tread)	76
Ratios: rear axle and transmission	75	Transmission: description	72
Rear axle: description	72	oil change	45
reduction gear lubrication	46	sectional view	73
sectional view	73	Troubleshooting	31-35
Rocking	37	Turn indicator lever	12
Safety flasher switch	12	Turning circle	76
Seat adjustment	6	Upholstery care of	29
		Valves: adjusting	55
		arrangement	74
		Vent wing	11
		Warning lights	21, 35, 67
		Weights	77
		Wheelbase	76
		Wheels: changing	35, 36
		rim size	76
			79

## Tools and Accessories that came with your VW Station Wagon

- 1 Fan Belt
- 1 Tool Roll
- 1 Spare Wheel
- 1 Jack
- 1 Wheel Cap Removal Tool
- 1 Square Key
- 1 Combination Pliers
- 1 Screwdriver with reversible Blade for slotted and Phillips screws
- 1 Open End Wrench 8/13 mm
- 1 Socket Wrench 14 mm
- 1 Socket for plugs, with bar
- 1 Socket Wrench for Wheel Bolts, Pulley and Jack
- 1 Bar for Socket Wrench
- 1 VW Service Booklet



The Identification Plate is located on the right-hand side of the fresh air duct in the cab.



The Engine Number is located on the crankcase flange for the generator support.



The Chassis Number is stamped on the engine cover plate near the battery.

Reference Data Record

Serial Number \_\_\_\_\_ License Plate Number \_\_\_\_\_  
Engine Number \_\_\_\_\_ Registration Number \_\_\_\_\_  
Chassis Number \_\_\_\_\_ Taxable Horsepower \_\_\_\_\_  
Ignition Key Number \_\_\_\_\_ Max. Gross Vehicle Weight \_\_\_\_\_  
Unladen Weight \_\_\_\_\_

Personal

Name \_\_\_\_\_  
Address \_\_\_\_\_  
City \_\_\_\_\_ State \_\_\_\_\_ Phone \_\_\_\_\_

Insurance Company

Collision/Comprehensive \_\_\_\_\_  
Liability \_\_\_\_\_  
\_\_\_\_\_  
\_\_\_\_\_  
\_\_\_\_\_

