

VOLKSWAGEN 1300

KARMAN
Ghia





COUPÉ AND CONVERTIBLE

KARMANN
by
Ghia

August 1965

VOLKSWAGENWERK · AG

Contents:	Operating instructions	4
	Practical driving	18
	Cold weather hints	24
	Care of the tires	27
	Care of the car	30
	Lubrication	34
	Maintenance	41
	General description	64
	Technical data	68
	Bulb chart	71
	Lubrication chart	73
	Lubricants	73
	Maintenance chart	74
	Tools and accessories	75
	Index	76
	Identification plate, Chassis and engine numbers	79

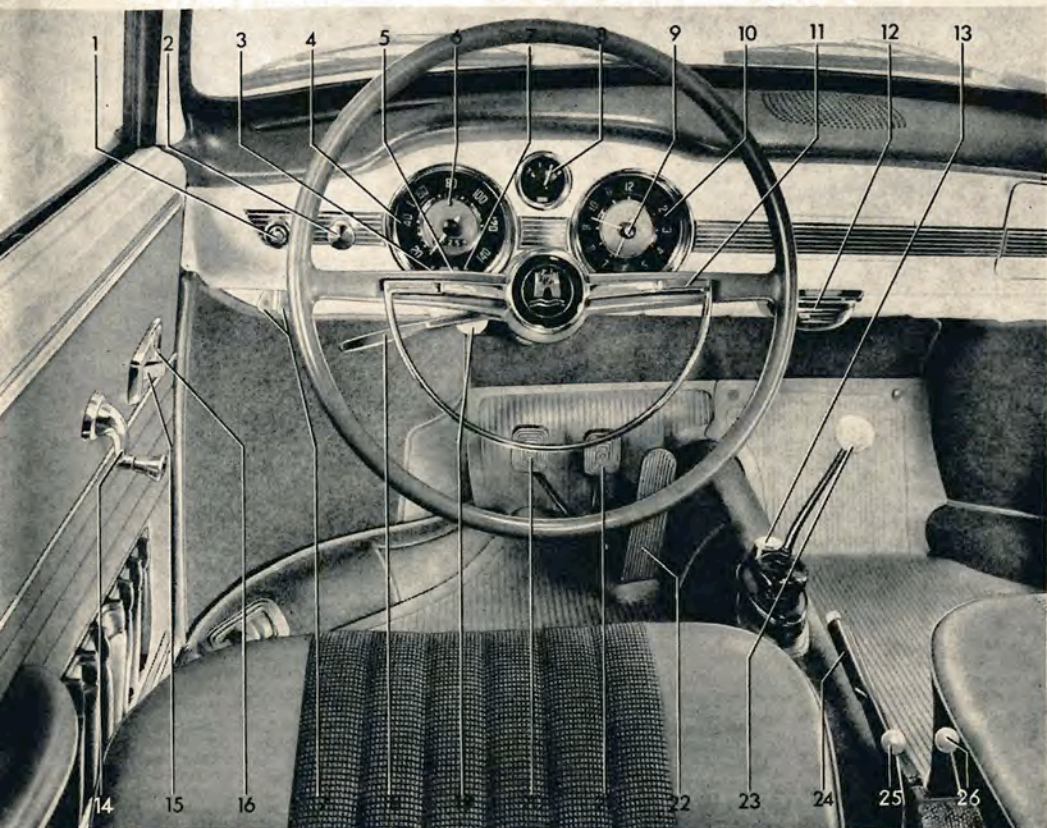

- | | |
|---|--|
| 1 — Windshield wiper and washer switch | 15 — Locking lever |
| 2 — Headlight and instrument lighting switch | 16 — Inner door handle |
| 3 — Generator and cooling warning light - red | 17 — Lever for fresh air ventilation |
| 4 — Speedometer | 18 — Turn indicator lever with dimmer / headlight flasher switch |
| 5 — Turn indicator warning light - green | 19 — Front hood control knob |
| 6 — High beam warning light - blue | 20 — Clutch pedal |
| 7 — Oil pressure warning light - green | 21 — Brake pedal |
| 8 — Fuel gauge | 22 — Accelerator pedal |
| 9 — Clock setting knob | 23 — Gearshift lever |
| 10 — Clock | 24 — Handbrake |
| 11 — Horn half ring | 25 — Lever for rear foot well heating |
| 12 — Ashtray | 26 — Heating control lever |
| 13 — Gearshift / starter lock | |
| 14 — Window winder | |

Operating instructions

Before driving off acquaint yourself with your new vehicle. You have been given a separate key for the door locks and the gearshift-starter lock. You should take note of the key numbers so that you can get a replacement if you should lose a key. Vehicles without the gearshift-starter lock have only one key to open the doors and operate the starter.



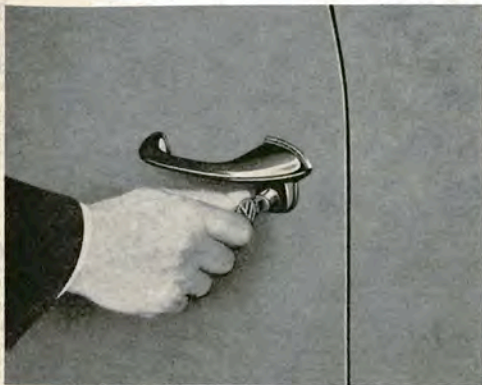

The doors can be unlocked from outside. A quarter of a turn with the key and the doors can be opened with the press button under the door handle.

Naturally both doors can also be locked from outside. It is, however, more convenient to push in the lever above the inner door handle and then to depress the button below the outer door handle when closing the door. If the door closes accidentally after the inner lever has been depressed, it will not lock itself automatically. This prevents you from locking the door unintentionally while the keys are still inside the car.

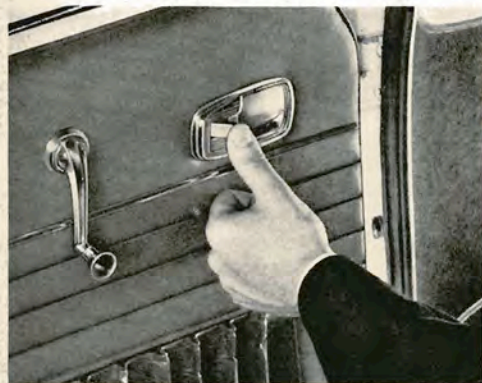

The front seats can be adjusted individually even when the vehicle is moving. To release the seat, just lift the lever at the front on the right. The seat can then be moved backwards or forward as desired. The seat runners are inclined so that the seat is raised as it is pushed forward and lowered as it is pushed to the rear.

The back rests of the front seats can be inclined to three different positions by moving a lever.

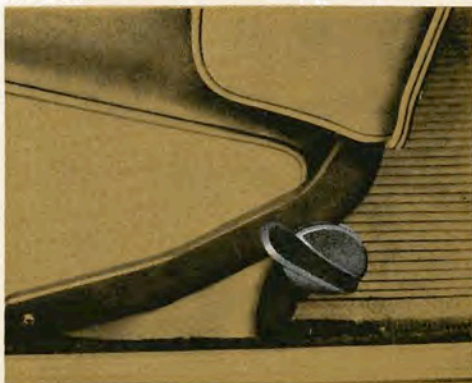

Sitting and driving for hours on end places a great strain on the human body. It is therefore essential to sit correctly when driving. Make full use of the possibilities of adjusting the seat to suit your individual requirements so that you still feel fresh even after driving for many hours.

The rear view mirrors are adjustable and should be set to give clear vision to the rear at all times without having to alter ones position. The height of the interior mirror can be altered by turning it 180°. Check the position of the mirrors every time the driver's seat is moved.



The sun visors can be swivelled towards the door windows and offer protection against the sun from the side.

The sun visor on the passenger's side is fitted with a make-up mirror.

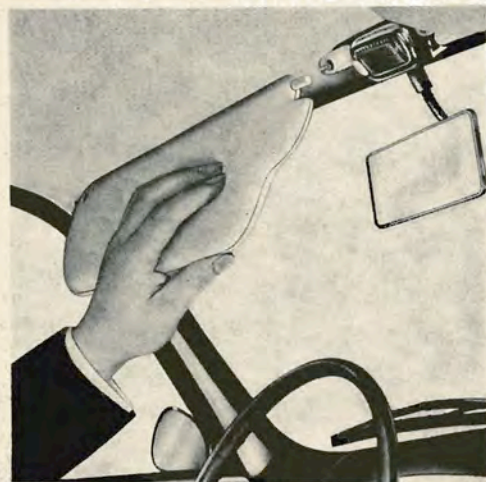

Turn indicator lever. You can operate the indicator lever with your fingers without taking your hands off the steering wheel.

Lever upwards - right indicator

Lever downwards - left indicator

As long as the indicators are switched on, a green double arrow in the speedometer dial lights up in time with the flasher impulses.

The indicators switch off automatically as soon as the steering wheel is returned to the straight-ahead position.

When the headlamps are on, they can be switched from high to low beam with the button in the turn indicator lever. A blue warning lamp in the speedometer dial shows when the headlights are on high beam.

When the lights are off or only the parking lights are on, the button in the turn indicator lever serves as a headlight flasher.



The windshield wipers are controlled by the switch on the left of the instrument panel. They park automatically when switched off.

The windshield washer is operated with the knob in the center of the windshield wiper switch. The washer is worked by compressed air so that by just holding the knob down you can spray water on to the windshield until the field of vision is quite clear.

Do not forget to check the windshield washer container from time to time. It is located under the front hood behind the spare wheel

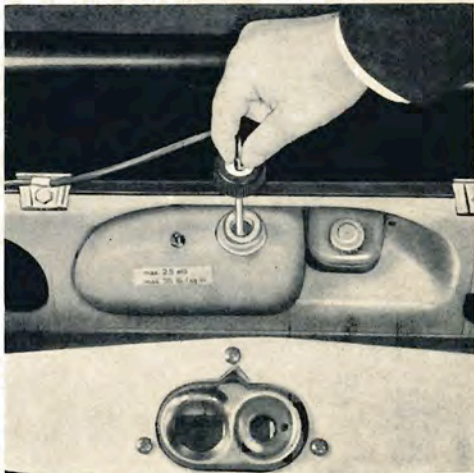

and holds about 1 quart of water. As the air pressure in the container escapes when the cap is removed, it is advisable to refill the container at a filling station. The container can be filled until it overflows. The pipe in the container neck ensures that there is always sufficient air to operate the washer. The correct air pressure is 2.5 kg/cm². (36 psi.). The addition of 25% pure spirit to the water in winter will protect it from freezing down to a temperature of approximately — 12° C (10° F). An anti-freeze solution can be used instead of methylated spirits. The correct mixing proportions are given by the manufacturers.

The wiper blades should be removed occasionally and thoroughly cleaned with a fairly hard brush and methylated spirits or a strong detergent solution. Particularly during long dry periods they tend to become clogged with tar splashes, oil and insects. The blades should be replaced once a year.



The lights are switched on with the pull switch near the speedometer. When pulled out to the first stop - you can feel the stop engage in this position - the parking lights, the rear lights and the license plate light are switched on. To switch the headlights on, pull the switch out to the second stop. The dimmer switch is in the turn indicator switch on the steering column.

The instrument lighting can be varied in brightness by turning the lighting switch. It can also be switched off completely by turning the switch to the left as far as it will go.

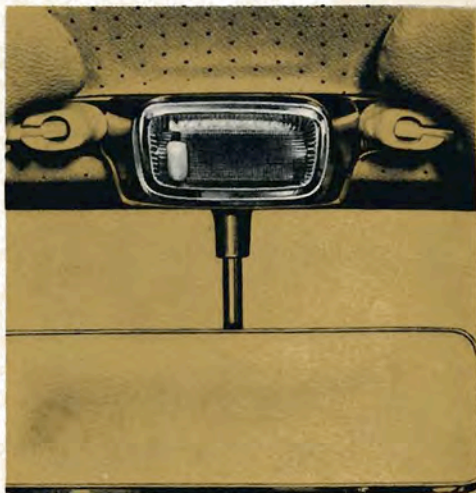

The interior light is located between the sun visors. The switch is built into the light and has three positions:

- down — light comes on when a door is opened
- center — light does not come on when doors are open
- up — light remains on when doors are closed



The fresh air ventilation can be controlled separately to each side of the vehicle by the two levers on the lower edge of the instrument panel. The air enters through the defroster vents at the windshield.

A — on

B — off

By turning on heating and fresh air ventilation at the same time you can admit a mixture of warm fresh air into the car.

The hinged quarter windows can also be used to control ventilation. Good ventilation of the interior calls for extraction of the fresh and warm air inside the body. It is therefore advisable to open a quarter window slightly even when it is quite cold outside. This will keep the windows clear and prevent the misting-up caused by the moisture in the occupant's breath.



The clock is electrically driven. To set the time, press the button in the dial inwards and turn.

The ashtray can be taken out after pressing down the leaf spring slightly. When the ashtray is pushed back in again, the spring engages automatically.

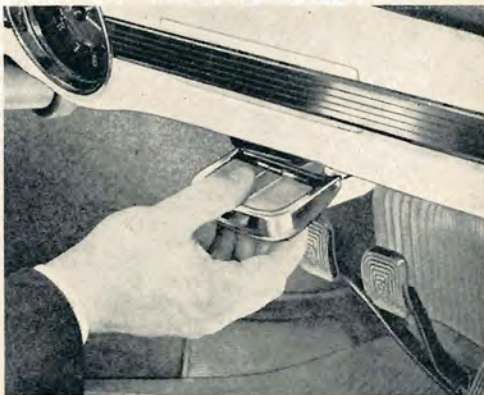

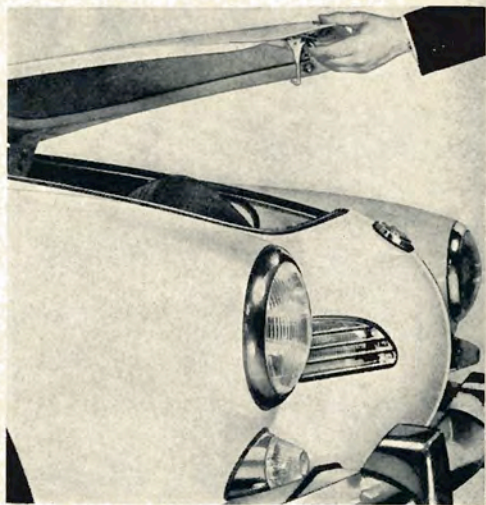

The luggage compartment under the front hood is theft-proof when the car is locked. The control knob for the hood is situated under the instrument panel on the left. The hood springs up slightly when the knob is pulled and can then be opened fully after pressing the safety hook upwards.

On the Convertible, the knob is fitted with a lock so that you can lock up the spare wheel, fuel tank and luggage when the vehicle is open. The key for the lock is also used for the door and the lockable glove box lid on the Convertible. When closing the hood, ensure that the lock engages firmly.



There is a second luggage compartment behind the emergency seats. This compartment is ideal for all the things you need to have handy when on the move. The rear back rest can be folded forward when loading and unloading luggage. If you wish to carry very large pieces of luggage you can secure the back rest to the seat support in this position. In the normal position, the back rest is held by a rubber loop.

The engine compartment is unlocked by means of the knob near the left lock pillar. The hood is held in the opened position by springs. To close it, press down on the license plate lamp housing until the lock engages.

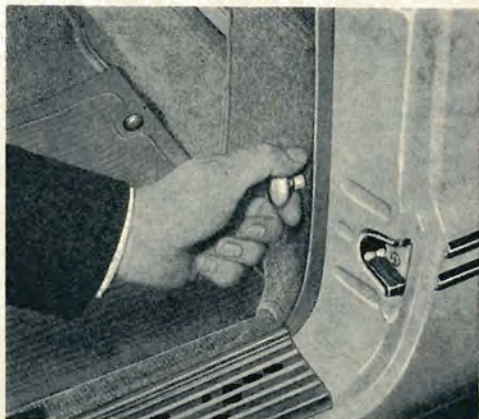

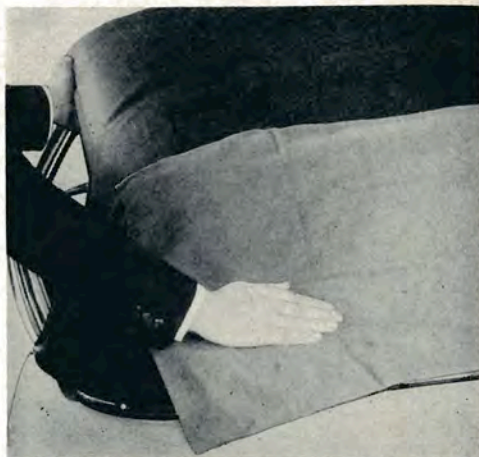
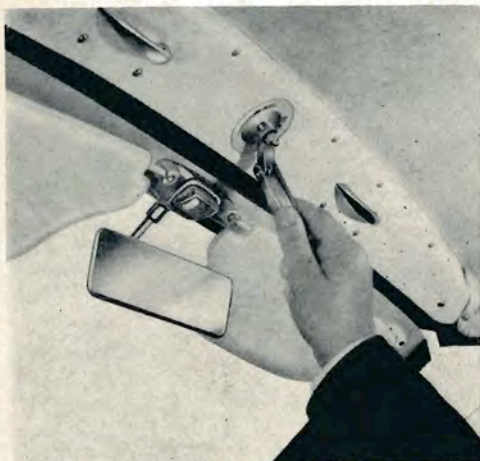

The Convertible top

can be raised and lowered easily by one person. As the life of the top depends on the way it is treated it is advisable to learn the few movements required off by heart.

The top must only be opened when dry. After driving on dusty roads for long periods we recommend that you wipe the top carefully before opening it in order to prevent the dust particles from damaging the material and causing friction marks. These marks can also be caused if the top is not held securely by the fasteners when it is open. When this is the case it is best to consult your VW workshop.

Fold the rear window and the top material smoothly between the bows with the back of the hand and lay the top slowly back at the same time.

Press the top down until the spring-loaded fasteners on each side engage.

Secure the top boot with the press studs inside first and then outside.

To open the top

Fold the crank handle down.

Unlock the top by turning the handle one full turn to the right.

Lift the top at the handles.

Lay the protective cloth over the rear window.

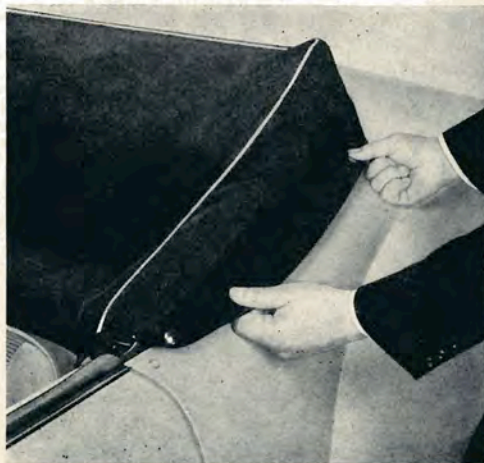



To close the top

Take top boot off.

Press top down and free the fasteners on each side.

Fold top forward.

Pull top down with the two handles until the locking levers engage in the slots.

Lock the top by turning the crank handle one full turn to the left.

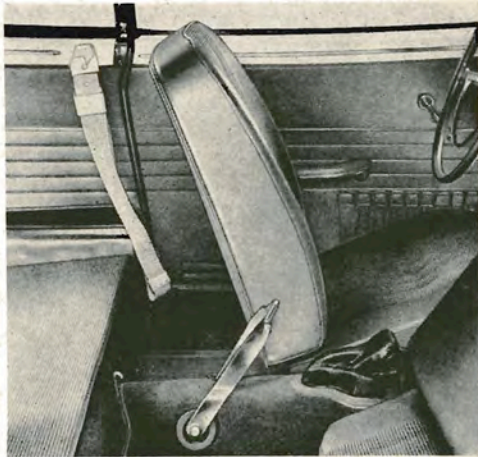
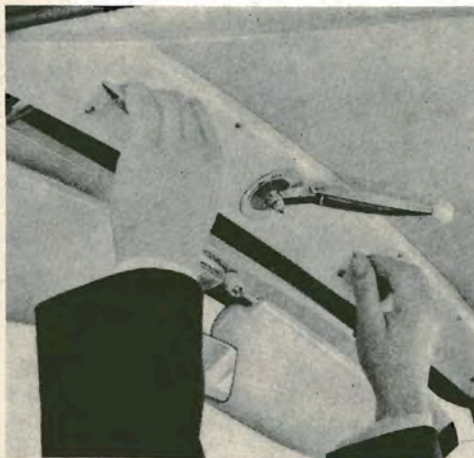

Safety belts are obtainable from any VW workshop. The securing points are on the lock pillar and on the frame tunnel in the rear footwell.

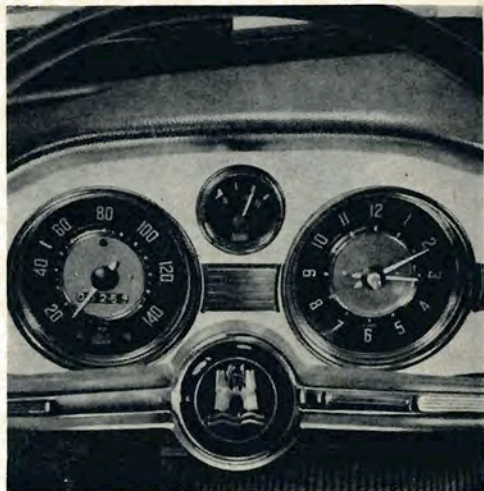

Please check

the brakes, lighting and the amount of fuel before every trip. The oil level and tires of your car should also be checked at regular intervals.

The fuel tank contains sufficient fuel when full, that is when the fuel gauge needle is hard over to the right, to cover a good 450 kilometers (280 miles). As soon as the needle moves to "R" (Reserve) it is time to refuel. There is still 5 liters of fuel left in the tank which is enough for 50 to 60 kilometers (30 to 37 miles) so that you can reach the next filling station.

The choice of fuels is left to you. The engine of your car is so designed that it will run satisfactorily on all normal reputable fuels which fulfil the octane requirements of the engine (87 O.N.). If regular fuel with adequate anti-knock properties is not available, premium fuel can be used or mixed with the regular fuel. All good brands, including premium and regular mixtures, are distinguished by their consistent composition and freedom from harmful ingredients.

The tank holds 40 liters (10.6 US gallons, 8.8 Imp. gallons). The filler neck is under the front hood which can be opened with the knob on the left under the instrument panel.

The brakes must be checked before starting out on a trip as the safety of your car depends mainly on them. When the car is in motion, depress the brake pedal a few times to make sure that the brakes are working efficiently.

The stop and turn indicator lights are an essential part of the lighting system. The ignition has to be switched on if you wish to check them.

If a turn indicator bulb is defective, the other lights and the warning light in the speedometer dial flash much quicker than they do normally. The stop lights only work when the brake pedal is depressed.

The oil level should only be checked when the engine is not running. It should always be between the two marks on the dipstick and must never fall below the lower mark. Wipe the dipstick with a clean rag before checking the oil level.

If possible always use the same branded HD oil (for Service MS).

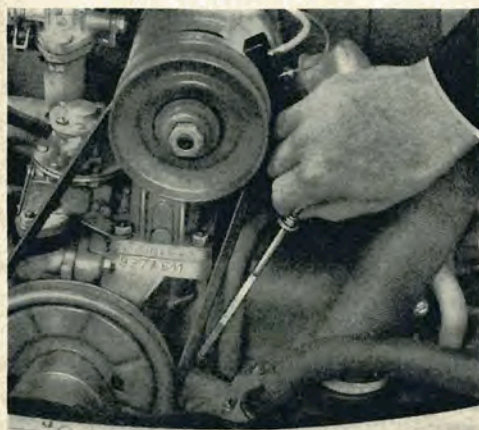

Tires

Correct tire pressures are essential for ensuring the excellent road-holding properties of your car. It is not too much to be expected for you to check the tire pressure occasionally.

When the car is fully loaded, the tire pressures should be 1.2 kg/cm² (17 psi.) at the front and 1.8 kg/cm² (26 psi.) at the rear. Otherwise 1.1 kg/cm² (16 psi.) at the front and 1.7 kg/cm² (24 psi.) at the rear is sufficient.

For long, high speed motorway trips, the tire pressures should be increased by 0.2 kg/cm² (3 psi.) at front and rear.

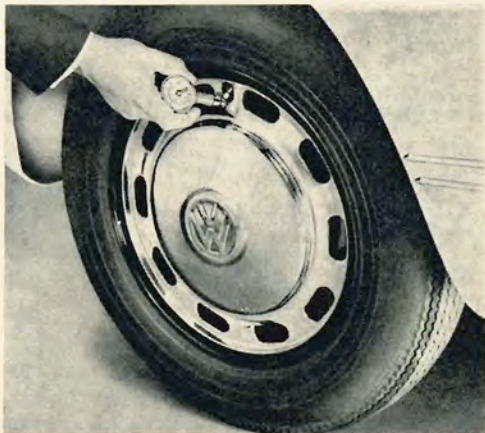



Starting the engine

The ignition and starter are switched on, one after the other, by means of the combined starter-ignition switch. As starter operation stresses the battery heavily, other big current users, such as the headlights, windshield wiper and radio, should not be switched on when starting. Make sure, also, that the gear shift lever is in neutral.

First switch on the ignition by turning the key to the right until the red and green warning lights in the speedometer come on. Then operate the starter without delay by turning the key further to the right.

At temperatures above freezing point or when the engine is still warm, depress the accelerator pedal slowly while operating the starter. Depress the accelerator pedal fully only when the engine is very warm.

At temperatures below freezing point and when the engine is cold, depress the accelerator pedal fully and then release it before switching on the ignition. This enables the automatic choke to close the choke valve. As the engine and transmission oil tend to become thick when cold, you should also declutch when starting so that the starter motor only has to turn the engine.

As soon as the engine starts, release the ignition key so that the starter is switched off. You can move off at once. The automatic choke regulates the mixture and idling speed to suit the operating temperature. Do not race the engine when it is still cold.

If the engine does not start within the first 10 seconds, pause for about the same length of time to rest the battery before repeating the starter operation. The ignition will have to be switched off first and then on again as a non-repeat lock in the switch prevents the starter from being operated repeatedly when the ignition is on and thus being damaged by the engine when it is running. The starting procedure should not be interrupted if the engine is heard to fire a few times.

The red warning light for the generator and cooling goes out as the engine speed increases. If this light comes on when you are driving, stop at once and check the belt which drives the generator. When this belt breaks, the cooling of the engine is interrupted. The proper way to replace the belt is described on page 42.

If the generator ceases to charge for any other reason, you can drive on, but only to the next workshop if possible as otherwise the battery will soon be run down.

The green warning light for the oil pressure goes out when the engine is started. If this warning light comes on whilst driving you must stop at once as the chances are that the oil circulation has been interrupted. Check the oil level at once. If the oil level is correct, get in contact with the nearest VW workshop.

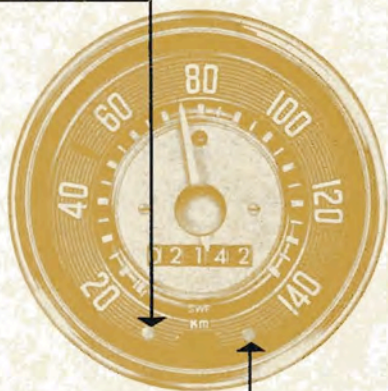

Caution

Be careful when starting the engine in the garage. Provide ample ventilation so that the exhaust fumes, which contain carbon-monoxide gas, can escape.

Practical driving

Breaking-in instructions are not necessary for your Volkswagen. The most modern production and inspection methods have made it possible to dispense with the initial speed restrictions which are normally required. You can drive the vehicle at full speed from the first day. It is advisable, however, to observe certain general driving rules.

Gear shifting

Glance occasionally at the speedometer especially during the initial period.

Shift the gears within the permissible speed ranges only:

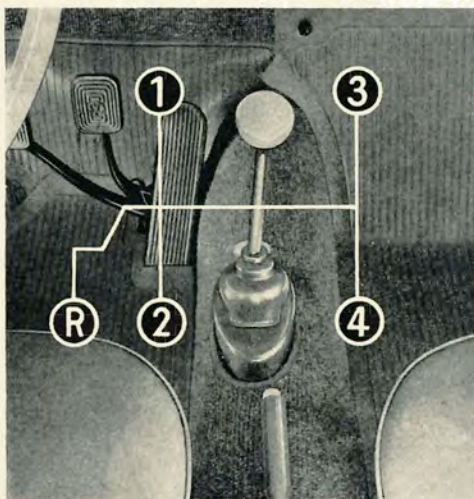

1st gear

0—15 mph
0—25 kph



You can drive very economically between:

Do not race or labor the engine in the individual gears. This practice can have a decisive effect on the life of the engine.

Engage the reverse gear only when the car is stationary. A locking device prevents unintentional shifting. Depress the gear lever slightly and then move it to the left and to the rear to engage reverse.

Shifting to a lower gear

Shift down to a lower gear in good time when on inclines and also when accelerating from low speeds. The transmission of your

2nd gear

6—30 mph
10—50 kph



6 and 22 mph
10 and 35 kph

3rd gear

18—50 mph
30—80 kph

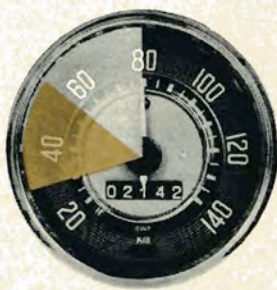

18 and 35 mph
30 and 55 kph

4th gear

28—80 mph
45—128 kph



28 and 62 mph
45 and 100 kph

car is fully synchronized so please do not hesitate to shift the gears.

Certain speed ranges have to be adhered to when shifting to a lower gear. Shifting down to a lower gear at excessive speeds puts an unnecessary strain on the transmission. On the other hand very low speeds in the individual gears are harmful to the engine. Shift down from 4th to 3rd gear approximately between 80 and 45 kph (50

and 28 mph) and from 3rd to 2nd gear between 50 and 30 kph (30 and 18 mph). The 1st gear is only used for moving off, driving at walking pace or on very steep inclines.

When shifting gears, it is absolutely essential to depress the clutch pedal fully. Incomplete declutching makes gear shifting difficult and leads to rapid wear of the synchronizer stop rings.

Economical operation is one of the outstanding features of your car. However, getting a few extra miles from each gallon depends on your driving habits:

Make good use of the lower speed ranges in the individual gears. Under normal circumstances you can shift into 2nd gear at 10 kph (6mph) into 3rd gear at 30—35 kph (18—21 mph) and into top at 45—50 kph (28—31 mph).

Depress the pedal gradually when accelerating. Only use the full acceleration and particularly the excellent brakes of your vehicle when a critical traffic situation makes it absolutely essential.

Do not pump the accelerator pedal unnecessarily. Even the small quantity of fuel additionally discharged each time the accelerator pedal is depressed results in a marked increase in the overall fuel consumption.

Do not continue to depress the accelerator pedal when your speed begins to drop on an incline, shift down in good time so that you keep the engine running at the best speed.

Reduce your speed in good time before corners and when stopping. Do not coast downhill. High speeds always result in higher fuel consumption figures and, what is more, the consumption does not increase uniformly but goes up rapidly.

However, you can drive quickly and economically if you accelerate to the desired speed and then ease the pedal back slowly to the point where the vehicle just remains at this speed. This method can prove very economical, particularly on long motorway trips.

The most advantageous engine operating conditions result from brisk driving and correct gear shifting.

Brakes

The brake responds to even the slightest foot pressure. Apply the brakes carefully and avoid locking the wheels. Locked wheels do not shorten the braking distance but may cause you to lose control over the vehicle and will affect the tires.

When driving downhill, make use of the braking effect of the engine and shift to that gear which you would use in driving uphill.

The ignition must never be switched off when going downhill.

Violent braking can only be justified in an emergency. Nevertheless, it is advisable to check the full braking effect at certain intervals so that you will be familiar with the behaviour of the car and the actual braking distance.

Parking

Parking in limited spaces can be quite simple:

Stop your car level with the car in front of the space. Turn the steering wheel sharply to the right and reverse slowly into the gap:

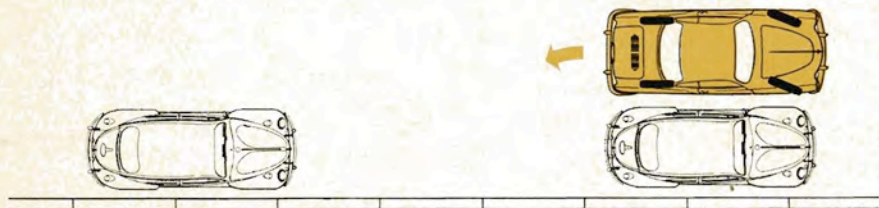

When the front bumper of your car is level with the rear bumper of the car ahead of you, turn the steering wheel fully to the left and back up further towards the curb:

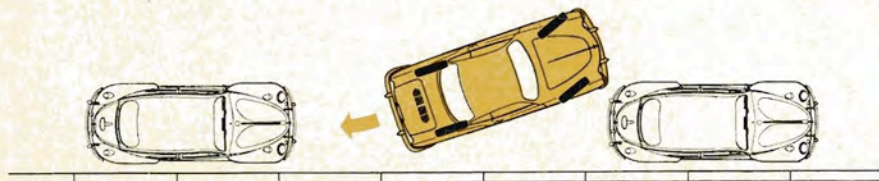

Now turn the steering wheel to the right again and pull up a little bit, until both ends of the car are as close to the curb as possible:

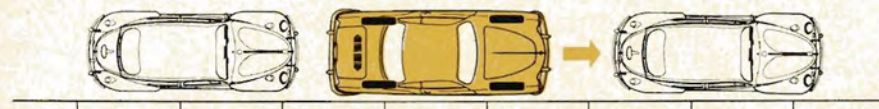

When parking on a steep slope, set the handbrake to stop the car rolling and engage reverse gear to be on the safe side. Do not forget to take the key out of the ignition switch before you leave your car.

If a gearshift-starter lock is fitted you can lock the lever in neutral or in reverse and protect the vehicle against theft.

Towing

Just in case you wish to attach a towrope to your vehicle one day, please note that the bumpers are not suitable for this purpose. If you do not expect the towing effort to be excessive, the rope can be attached at the rear to a lower shock absorber bracket. Otherwise, we advise you to use the cross tube which houses the torsion bars for the rear suspension. Neither of these points are very easy to reach but they at least ensure that your desire to help does not result in damage to your vehicle.

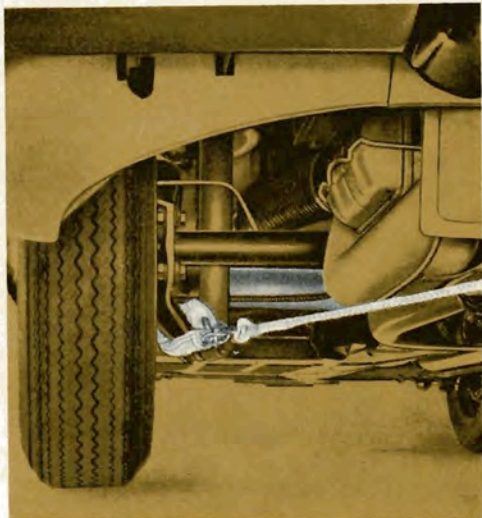

At the front, the rope should be attached to the lower axle tube as near to the frame head as possible.

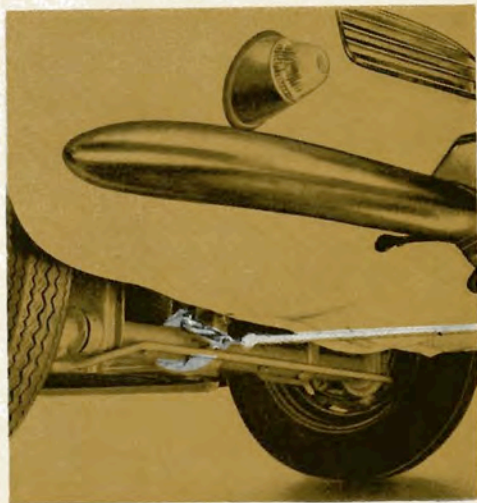

Cold weather hints

Your car has two features which you will appreciate: Air cooling and heating. You can leave your car out in the bitter cold without fear. Its air-cooled engine will always be ready to start and supply warm air for the interior of the car.

The warm air heating can be fully regulated. The distribution of warm air can be varied to suit the wishes of the occupants by means of controllable outlets at foot level.

The right-hand lever between the front seats turns all the heating on and off and the left-hand lever controls the heating in the rear foot well. The outlets in the front foot well can be closed with slides.

At very low temperatures, it is advisable to always close the rear outlets when first moving off. This increases the flow of air to the windshield and the rear window and also helps to prevent steaming up when air humi-

Lever up — on
Lever down — off

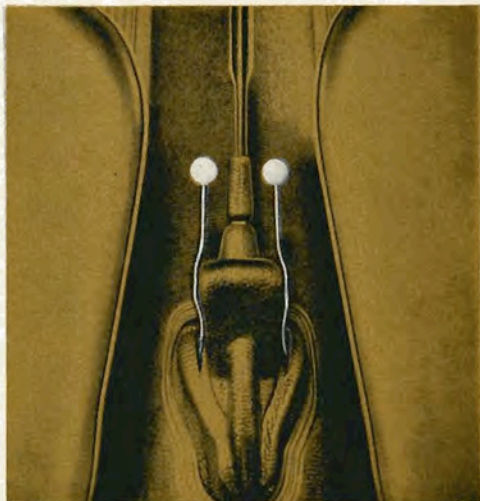

dity is high. As soon as the windshield is clear, the rear foot level outlets should be opened so that the interior of the body heats up as quickly and uniformly as possible.

If you open a window slightly when the heating is on, the heat output will increase noticeably because the fan can then force the warm air into the body more easily.

Never attempt to influence the cooling and heating of your car in winter by covering the air intake slots below the rear window. These slots must always remain open to ensure the flow of fresh air to the carburetor and fan.

Engine oil. SAE 30 oil will thicken at temperatures below freezing point and result in difficult starting. Change over to the thinner SAE 10 W engine oil at oil changes when temperatures under freezing point are expected.

If your car is operated mainly over short distances **during** the winter it is advisable to have the oil changed at more frequent intervals, say every 2,500 km. (1,500 miles), using the right HD oil.

If you only drive a few hundred miles a month under these conditions, it is advisable to have the oil changed every 6 to 8 weeks. In the warmer seasons, additional oil changes are unnecessary and uneconomical.

In territories where exceptionally low temperatures prevail (below — 25° C / — 13° F), SAE 5 W oil should be used instead of SAE 10 W and the oil changed every 1,250 km. (750 miles).

Transmission oil. SAE 90 oil can generally be used all the year round. Only in countries with arctic climates is it necessary to replace it with the thinner SAE 80.

The chassis is naturally exposed to very severe conditions in the winter. The steadily

increasing use of chemicals to de-ice the roads produces solutions which attack even the most durable paintwork after a time. The underside of your vehicle is sprayed with a wax-based compound to protect it from these influences. It is advisable to examine the protective film at the beginning of the winter and have it repaired by respraying so that the full protective effect is retained.

Oil-based anti-corrosion compounds should not be applied to the wax-coated underside of the vehicle.

The battery requires special care in winter because of the increased consumption of current when starting the engine and using the lights at night. Furthermore, its efficiency decreases at low temperatures. If the car is mostly used over short distances or in city traffic, it is advisable to have the battery recharged occasionally. The connections between battery and starting motor must be kept perfectly clean.

The spark plugs should not have an excessively large gap especially in winter. The normal spark plug gap is 0.7 mm. (.028"). In extremely cold weather the gap can be reduced to between 0.4 and 0.5 mm. (.016" and .020") to facilitate starting.

The brakes are exposed to splash water and condensation which in winter is apt to freeze in the brake drums. Therefore, when parking your car engage reverse gear but do not set the handbrake.

The door lock can freeze up in winter, especially if water gets into the lock cylinder when washing the car. Do not aim the water jet directly at the lock, but instead, cover up the key hole when washing. A frozen lock can be opened by warming the key before insertion and then squirting anti-freeze into the lock cylinder straight away.

Tires with badly worn treads are very dangerous particularly in the winter so ensure that they are replaced in good time.

M + S tires with special heavy treads give good road holding in snow and slush. They can be fitted to all four wheels, but should not be fitted to the front wheels only.

Better still are M + S ice tires (spiked) which increase the safety margin even on hard snow and ice. Even with these tires, which should always be fitted to all four wheels, you should not allow yourself to be misled into driving faster than you would under the same conditions with normal M + S tires.

In general, special winter tires only have real advantages when conditions on the roads are really wintry. For safety reasons, it is not advisable to drive a vehicle fitted with any type of winter tire at top speed. You cannot expect a winter tire to have the same degree of adhesion on dry snow-free roads as a normal tire. Furthermore, under these conditions M + S tires wear rapidly, particularly at high speeds.

Snow chains, in conjunction with normal and winter tires, can only be used on the rear wheels. Only thin chains which do not stand clear of the tire tread and walls more than 13 mm, including tensioner, are suitable. When driving over long stretches of road which are free of snow the chains should be removed. They serve no useful purpose here and merely damage the tires and wear out quickly.

Apart from the tire pressures, your driving habits also affect the service life of the tires considerably. Rapid acceleration, violent braking and cornering result in more uneven tire wear than careful driving.

Avoid overloading the car and protect the tires from intense sunlight, fuel or oil.

The tires should be checked occasionally for foreign matter and external damage.

The tires should always be replaced when the tread has worn down to a depth of 1 mm (.04") which is the absolute minimum required for safe usage. If the tires show signs of uneven wear after a considerable mileage consult your local VW dealer.

Statically and dynamically balanced wheels have a beneficial effect on the driving characteristics of the vehicle and on tire life, particularly at high speeds. The wheels are balanced but as they can get out of balance in time due to natural tire wear they should be balanced again every 10 000 km (6 000 miles).

When mounting the tires, the red mark should be positioned at the valve so that the unbalance is equalized to a certain extent.

Care of the tires

Changing wheels

The spare wheel, jack and tools are found under the front hood which is opened by means of the knob under the instrument panel. The jack is secured by a clip near the spare wheel.

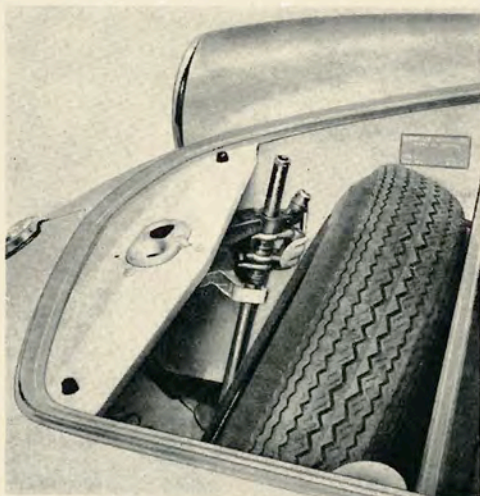

Set the hand brake.

Take off the wheel cap with the removal tool and loosen the wheel bolts about one turn with the wrench and operating bar.

Insert operating bar into lower link on jack and press the square support bracket down to the bottom of the jack.

Insert the jack in the square tube on the frame and push down the jack base plate until it makes contact with the ground.

Insert the operating bar into the jack and raise the car until the wheel is clear of the ground.

Remove wheel bolts and take off the wheel.

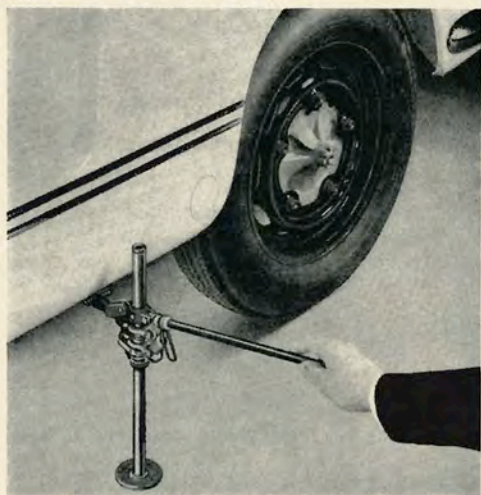



Raise the car until the five holes in the wheel are nearly in line with the holes in the brake drum.

Insert one wheel bolt and tighten it to such degree as to allow the wheel to be swung round this point by hand until the remaining holes in the wheel and brake drum coincide.

Insert the other wheel bolts.

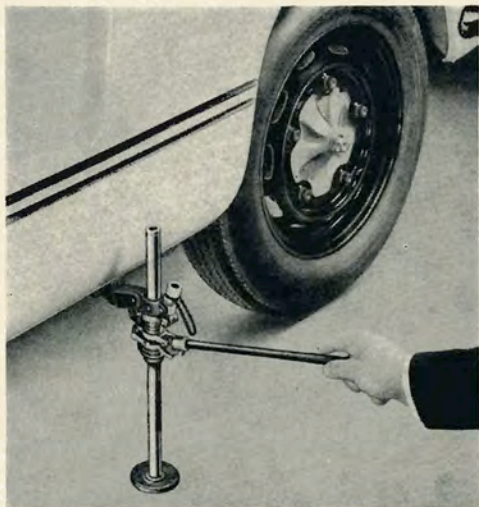

Tighten the screws until the wheel, centered by the spherical shape of the screw heads, contacts the brake drum evenly.

Place the bar in the lower link on the jack and lower the vehicle.

Fully tighten the screws uniformly.

Place trim ring in wheel and install wheel cap with a firm blow with the hand.

Care of the car

Clean and smart appearance. To keep your car looking smart and new should be a matter of pride to the driver or owner. It is our object to provide you with paintwork which not only looks good and has a sparkling lustre but is most durable. A chemical treatment protects the body against rust and anchors the synthetic resin enamel to the metal.

Even the best paintwork requires regular care. You will realise the importance of this if you consider that the paint is exposed to sunshine, rain, dust, and dirt.

Wash your new car frequently during the first weeks as this is good for the finish. When washing you require a soft sponge for the body, a soft brush for the wheels, a sturdy, longhanded brush for the chassis, and plenty of water.

The chassis and underneath part of the body should first be flushed with water to soak off the dirt, and afterwards a brush should be used.

Spray the exterior finish of body and wheels evenly with water until dirt is soaked off. Do not allow a powerful jet of water to hit the painted surface. Using plenty of clear water, remove dirt with a sponge. Clean the sponge at short intervals to avoid scratching the paintwork.

There are many proved auto soaps and detergents available which greatly facilitate this job. Do not buy just any product, let your VW dealer advise you. It is of utmost importance to rinse the body thoroughly with water to ensure that no traces of the detergent remain on the body. After washing, dry off with a clean chamois to prevent water spots from forming.

Preservation (Waxing) should be carried out for the first time after approximately 8 to 10 weeks and afterwards, if possible, at regular intervals of between 6 and 8 weeks. Waxing means to restore to the finish certain substances it has lost by exposure to the weather. At the same time a protective water-repellent coat of wax is applied to the body.

The "Genuine VW Preservative" (L 190) was specially produced for the Volkswagen and is obtainable from every VW dealer. After washing and drying the car thoroughly, apply the preservative thinly with a soft cloth. Let it dry for approximately 20 minutes and then rub it down with polishing cotton or a soft polishing cloth until iridescent colours can no longer be seen when you are standing at an angle to the polished area.

Do not forget to wax the car after each detergent washing as the intensive cleansing properties of the chemical detergent will partially dissolve the protective film of wax.

Polishing. You should polish your car only if its appearance has been affected as a result of insufficient care, or if the application of the preservative no longer restores the original lustre. Avoid the use of abrasives or chemically harmful products.

A special polish for the synthetic-resin enamel finish is also available from your Volkswagen dealer under the designation "Genuine VW Polishing Fluid" (L 170). Prior to applying the polish, the car must be washed and dried carefully. The polish should be applied with a soft clean cloth or polishing cotton — use a straight horizontal or vertical motion rather than a circular motion. After rubbing for some time you will notice a slight resistance, which indicates that the ingredients of the polish have settled in the finish and that the solvent has evaporated. Now take clean polishing cotton and rub the body down until the high polish is restored.

To prevent the polishing fluid from drying off prematurely, do not apply it on too large an area of the body at a time. A subsequent application of the preservative and your efforts will be rewarded with a long-lasting shine.

Never wash, wax or polish the car in sunlight.

Tar spots. Tar splashes have a tendency to corrode the finish within a short time and should be removed as soon possible with Genuine VW Preservative.

On the road you usually have nothing at your disposal but fuel. Kerosene or turpentine may also be used. After this, the treated spots should be washed with a mild, luke warm detergent solution, and rinsed, in order to remove traces of the cleansing agent.

Insects are caught, especially in hot weather, on the front of the car and on the windshield. Insects should not be allowed to remain on the paint finish for long and should be removed with water and a sponge. Once baked on they can only be removed with luke warm detergent solution.

Parking under trees. Vehicles which are parked under trees for long periods in summer are often found to be covered with spots. These spots can be removed fairly easily with luke warm detergent solution if the treatment is not delayed too long. It is advisable to apply a coat of preservative afterwards.

Chrome parts should be treated with "Genuine VW Chrome Cleaner Chromlin" when dry. Apply Chromlin thinly and allow to dry for 10 minutes before polishing with a dry cloth.

The Convertible top does not require any special attention. It is, however, essential to clean the plastic top cover regularly and in good time. When very dirty, it should be cleaned with a soap solution or a normal plastic cleaner. A hard brush can be used to remove dirt from the grained surface of the material but take care that the brush does not scratch the paint at the rear edges of the top. When the top has been cleaned, the whole vehicle should be rinsed thoroughly with clean water.

Never attempt to remove spots from the top with paint thinner, chlorine based spot removers or similar solutions because they will damage the plastic material. The spots should be wiped off with a benzine moistened cloth and the area then washed thoroughly with an lukewarm soap solution.

Cloth upholstery. If a vacuum cleaner is not available, the upholstery should be cleaned thoroughly with a brush or whisk broom. Stains can generally be removed with luke warm soap suds. Grease and oil stains are removed with cleaning paste or cleaning fluid. Do not pour the cleaning fluid directly on the upholstery as otherwise rings will form. Moisten a clean, uncoloured cloth with the fluid and rub with a circular motion, starting outside the spot and working inwards.

Leatherette headlinings, side trims and seats can best be cleaned with a soft cloth or soft brush. If very dirty, use a luke warm detergent solution or a dry foam cleaner.

Grease and paint spots should be wiped off before they dry on. Soaked-in spots can be removed by wiping carefully with a rag moistened with fuel or alcohol. Spots caused by shoe polish can be removed with turpentine. Use these agents carefully and sparingly as they tend to dissolve the dust-repellent finish of the leatherette. Solvents such as trichlorethylene or paint thinner must not be used for cleaning.

After cleaning, the leatherette should be dried thoroughly with a soft cloth. So-called preservatives are not suitable for leatherette because they do not soak into the material and will merely collect dust and make clothing dirty.

The windows can be cleaned best with a clean sponge and warm water. A glass cleaning solution should only be added to the water in exceptional cases as these solutions tend to affect the paint preservative. Always use a special clean leather to dry the windows. This leather must not be used for the paintwork in any circumstances as most paint cleaners and polishes contain ingredients which will cause unpleasant streaks to appear on the windshield when it rains, even if only the smallest trace is present.

These streaks can only be removed with a good windshield cleaner and a lot of care. Do not forget the windshield wiper blades.

Door and window weatherstrips. It is important to keep the rubber parts undamaged and supple to ensure perfect sealing. To retain the original flexibility of the rubber, these parts should be coated occasionally with talcum powder.

Airing the interior. If the car is left in your garage for a long period, it must be aired regularly. Permit air to circulate freely by opening the doors and lowering the windows to prevent the formation of mould and damp stains.

Lubrication Service

To lubricate correctly means to lubricate carefully and at the prescribed intervals. Therefore, do not omit to have the lubrication service carried out at regular intervals. A lubrication chart indicating the correct mileages at which to lubricate can be found on page 73.

The Service Booklet makes it possible for you to have your car lubricated at our authorized workshops by skilled personnel, at the lowest cost and in a minimum of time. You really cannot afford to miss this opportunity.

Engine

Regular oil changes are necessary even if the very best branded oils are used. Dirty oil in your engine simply means increased wear and a shorter service life.

Draining engine oil

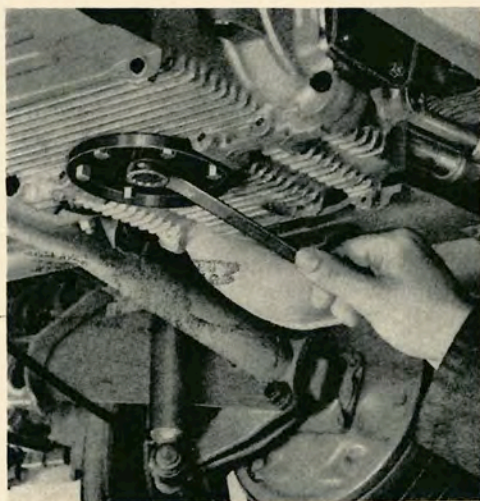

The oil is drained, when warm, by removing the plug in the oil strainer cover plate. Flushing of the engine is unnecessary but the oil strainer must be removed and cleaned at every oil change. The two gaskets and the washers for the cap nuts must be renewed each time. The engine is refilled with 2.5 liters of HD oil (5.3 US pints/4.4 Imp. pints).

It is superfluous and uneconomical under normal operating conditions to change the oil at shorter intervals than every 5,000 km (3,000 miles). We recommend oil changes at more frequent periods only in winter if you drive mainly short distances and in city traffic or only cover a few hundred miles a month under the same conditions.

Cleaning oil strainer

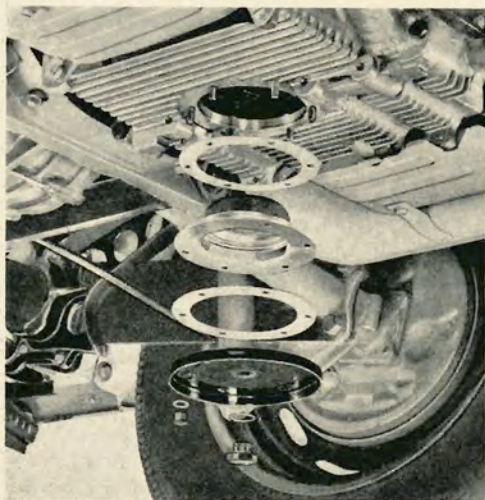

Putting engine oil in

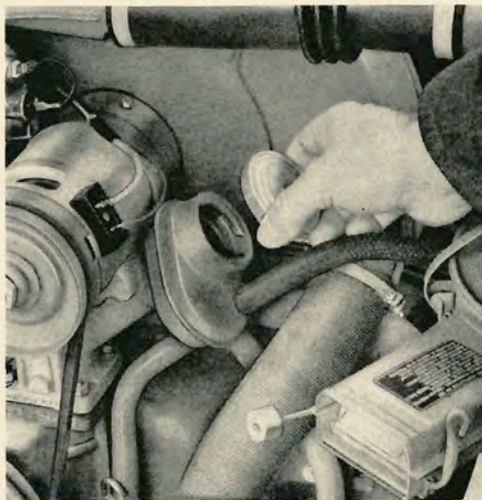

Types of lubricant

HD oils are prescribed for the engine lubrication. HD oil is an oil with proved oxidation stability, bearing corrosion prevention properties and detergent-dispersant characteristics which tend to hold in suspension foreign contaminants which would normally deposit on engine parts. These foreign contaminants will drain out with the oil at the periodical oil changes. The detergent properties of HD oil will make the fresh oil darker after a short time in use. This is quite natural and there is no reason whatsoever to change the oil earlier than called for in the Lubrication Chart.

Some more information on oils

The quality of branded oils is such that the choice is left to your discretion. In cases of doubt, your authorized VW dealer will be glad to assist you. We recommend that you select "your" oil after the first 500 km (300 miles) and stick to it at all future oil changes.

The viscosity grades of the different oils are shown by the designations SAE 30, SAE 10 W and so on. The viscosity of a lubricant is an indication of its resistance to flow at a given temperature. The lubricant chart on page 73 shows you which oil to select to suit the existing temperature.

Temporary deviations in the temperatures for the various viscosity grades are of no importance. It is permissible to mix oils of different viscosity grades when it is necessary to add oil between the oil changes, and the outside temperature no longer corresponds to the viscosity grade of the oil in the engine. It is, however, essential that the same brand of oil be used.

In some countries the API classification is applied (API = American Petroleum Institute). According to this classification, the HD oils suitable for the VW engine are referred to as "For Service MS". No additives of any kind should be mixed with HD oils.

Transmission

The transmission and differential gears are combined in the transmission case and both lubricated with hypoid oil. The oil should be up to the edge of filler hole. At oil changes — at 500 km (300 miles) and then again at 50,000 km (30,000 miles) — the old oil is drained by removing both the magnetic drain plugs while the oil is at operating temperature. The magnetic drain plugs should be thoroughly cleaned. The transmission is filled with 2.5 litres (5.3 U.S. pints/4.4 Imp. pints) of branded hypoid oil.

Additives should not be used with hypoid oils.

Draining the transmission oil

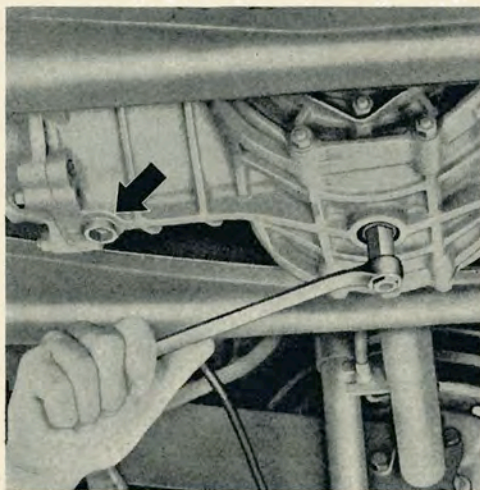

Putting transmission oil in

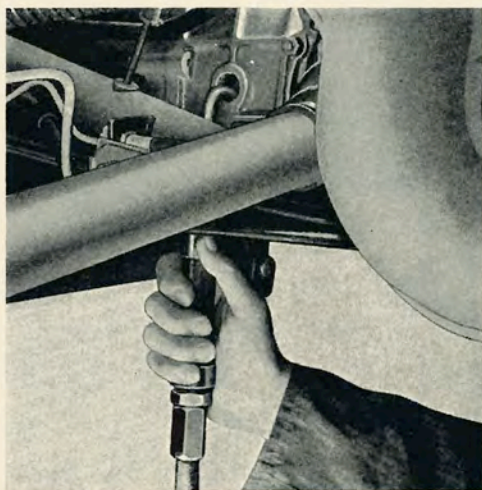

Chassis

The front axle can only be lubricated properly when the axle is free of load, that is, with the vehicle lifted.

The front axle has four grease fittings which must be lubricated every 10,000 km (6,000 miles).

Prior to lubrication, the grease fittings should be cleaned thoroughly with a cloth to prevent dirt from being forced into the bearings.

The dust seals of the maintenance-free ball joints and the tie-rod ends must be checked

for damage and security at every lubrication service. Damaged seals should be replaced immediately if possible.

Oil and grease should be kept off the tires and brake hoses. Even small quantities should be wiped off immediately.

Annually at the beginning of the cold season the cables for the accelerator, clutch and heating as well as the clutch cable adjusting nut should be checked and, if necessary, cleaned and lubricated.

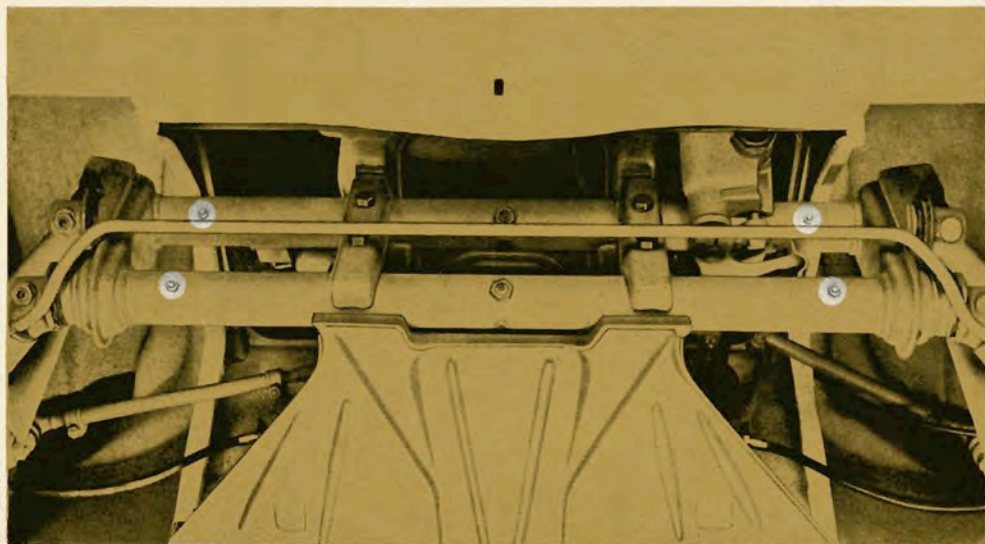

The front wheel bearings

are packed with grease at the factory. The caps on the front wheels hubs must be free from grease.

Every 50,000 km (30,000 miles) the bearings should be carefully cleaned and packed with the grease prescribed under „Lubricants“.

The brake drums must be removed for this purpose. Finally the front wheel bearings must be adjusted. In order to avoid damage to the bearings, this operation should, if possible, be carried out in a VW workshop only.

Front seats

If the front seats become hard to push, the runners should be greased lightly from above and below. Before greasing, the runners must be cleaned with a cloth. The seats can be taken out of the runners by pushing them right forward.

Doors and hoods

The door hinges are the maintenance-free type and do not need oiling.

The lock cylinders are lubricated with graphite. The key should be dipped in graphite powder and then turned to and fro in the lock a few times.

All sliding surfaces on locks and striker plates should be greased lightly as and when necessary. Hood hinges should be oiled and the locks greased lightly.

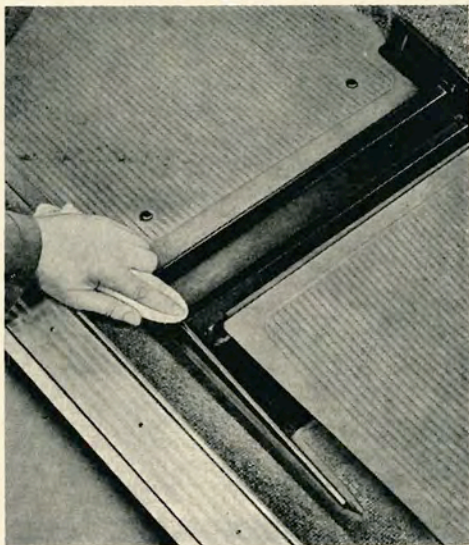

Convertible top

As and when necessary, the pivot points of the top linkage should be cleaned carefully and lubricated with a few drops of oil. Afterwards, it is advisable to wipe the joints thoroughly to prevent the top material from being soiled by excess oil.

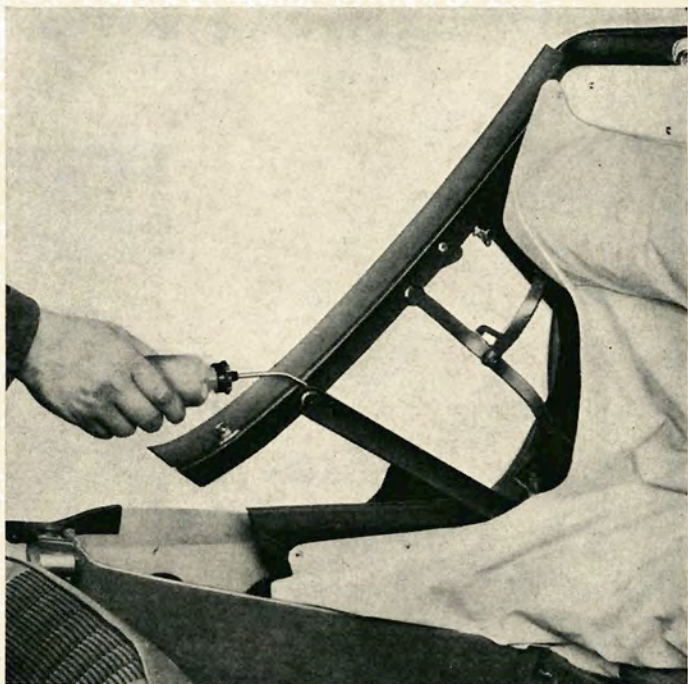

The Volkswagen Service Organization has made available for you an extensive network of authorized VW workshops staffed with well trained and experienced personnel, and equipped with all the special tools required to service your car. If ever you should need service when touring and away from home, look for the well-known VW Service Sign. Here you will receive prompt and expert assistance.

Maintenance Service

In case you cannot get to an authorized VW workshop quickly and have to carry out small repairs yourself, we have listed here the most important tasks which are normally part of the maintenance check. However, it is important that repair jobs which are beyond your capacity should be performed by the nearest VW workshop. Your car is then in capable hands. This will save you time, inconvenience, and money.

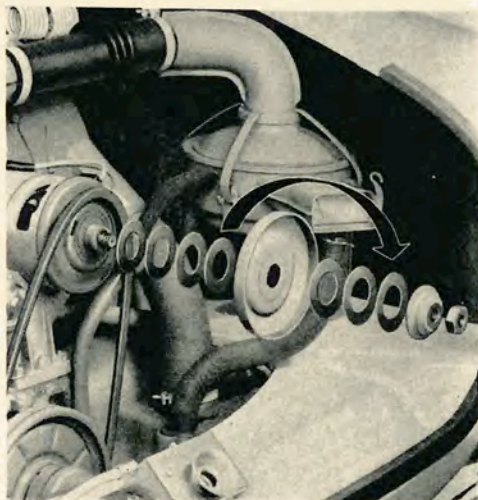
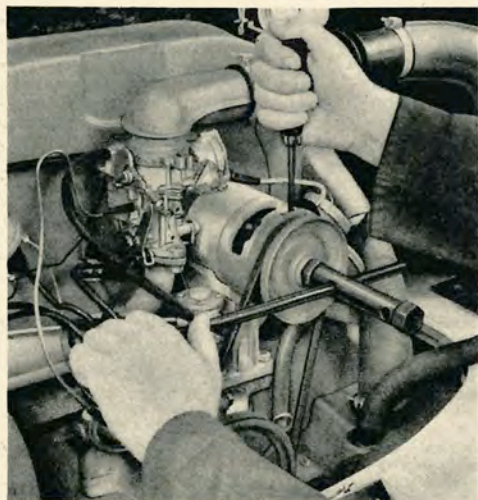

Checking the V-belt

The belt which drives the generator and the fan should be checked at regular intervals for tension and wear. When pressed with the thumb it should yield approximately 1.5 cm. (.6") and should not show signs of excessive wear.

To adjust the belt, remove the rear half of the pulley on the generator. When loosening and tightening the nut, insert a screwdriver in the slot in the front half of the pulley and support it against the upper housing screw in the generator. To replace the belt, the cover plate for the crankshaft pulley must also be taken off after removing the securing screws.

The belt is tensioned by increasing or decreasing the number of washers between the pulley halves. Taking washers out increases the tension and putting them in decreases it. New belts stretch slightly at first and must be checked after 500 km (300 miles) and the tension corrected. The tension does not change any more after this so it is not necessary to re-adjust the belt again. To have the belt too tight is just as bad as having it too loose.

Even though the belt normally has a long service life, it is advisable to always carry a spare.

Checking air cleaner

The oil bath air cleaner should be checked every 10000 km (6000 miles).

All the dust present in the air drawn in by the engine is retained by the filter insert in the upper part of the air cleaner and washed out when the vehicle is in motion by the oil in the lower part of the cleaner. In time, this causes a layer of sludge to form at the bottom of the lower part. If the cleaner check reveals that there is only 4—5 mm (.16—.2") of oil above the sludge layer, the lower part should be carefully cleaned and filled with fresh oil. The top part does not need cleaning. However, if the filter insert has become so dirty due to delayed cleaning or oil shortage that the air inlet holes on the underside are partly blocked, the encrusted dirt should be removed, preferably with a small piece of wood.

A dirty filter insert not only reduces the engine output, it can also cause premature wear in the engine. If the local conditions are such that the vehicle is frequently driven over very dusty roads it is advisable to clean the air cleaner more often.

The warm air control flap should be checked each time for freedom of movement. This flap regulates the flow of pre-heated air to the carburetor in conjunction with the speed of the engine.

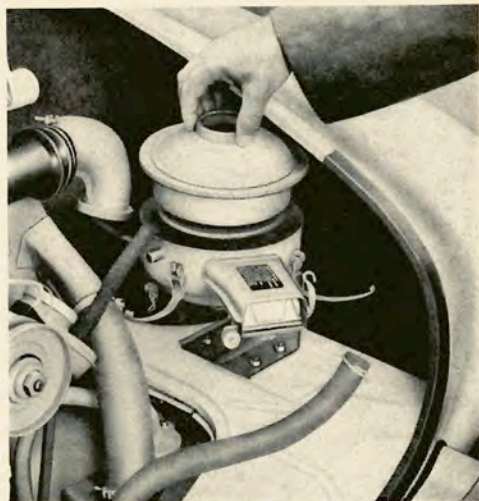

Servicing air cleaner

Pull crankcase breather hose off air cleaner.

Pull pre-heater hose off air cleaner intake elbow.

Loosen four quick-release clips and take intake pipe off upper part of cleaner.

Take upper part out. The upper part must never be laid down with the filter insert upwards.

Loosen two clips and take lower part of cleaner out.

Clean the lower part thoroughly and fill to the mark with fresh engine oil.

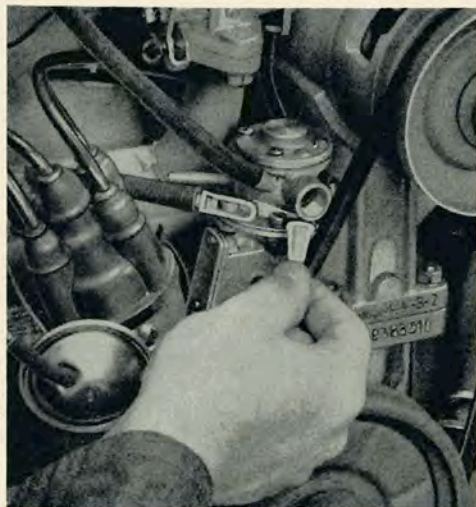

Cleaning the fuel pump filter

The fuel pump filter prevents foreign matter and water from entering the carburetor. It should be removed and cleaned at the prescribed intervals.

Pull suction line off pump and seal it.

Remove plug and take out filter.

Wash filter thoroughly in benzine.

When installing the filter do not omit the gasket for the plug.

Ignition timing

Particular attention must be paid to correct ignition timing. In many cases, poor performance, high fuel consumption and even damage to the engine can be the result of incorrect ignition setting. The ignition must not be advanced arbitrarily even when using premium fuels. Altering the ignition is not only pointless it can, as stated above, damage the engine.

Before setting the ignition timing the breaker contact point gap must be checked. With the breaker arm fully lifted by the cam, the clearance should be 0.4 mm (.16"). The initial spark advance must be set to 7.5° before top dead centre. The ignition timing must be set with the engine cold or when it is slightly warm.

Cleaning contact points

A certain amount of material movement takes place between the contact breaker points in the course of time. This creates a small build-up and a crater on the contact surface of the points but does not normally affect the ignition system. It is important, however, to ensure that the points are always clean and free of oil and grease. The best way to clean the points is to pull a piece of cardboard between them while pressing them lightly together. Badly burned points should be replaced.

Lubricating ignition distributor

The breaker arm fiber block in the ignition distributor should always be lightly greased with lithium grease. Every 10000 km (6000 miles) check whether this location must be cleaned and provided with new grease. Only a very small amount of grease should be used and none of it must come in contact with the breaker points as otherwise the ignition will be affected.

Adjusting contact points

Remove distributor cap and rotor.

Turn the engine by means of the generator until the contact arm rests on the highest point of the cam lobe.

Loosen the breaker point locking screw.

Insert a screwdriver between the two lugs on the contact plate and the slot in the point carrier and adjust the gap to 0.4 mm (.016") as at (a).

Tighten locking screw and install rotor.

After the contact points have been adjusted, the ignition timing must be reset.



Setting ignition timing

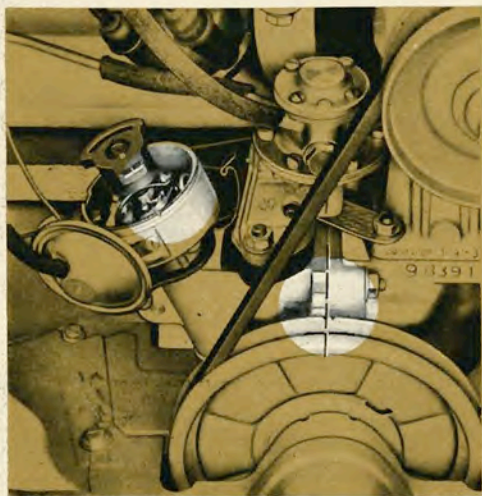

Turn the engine clockwise until the left-hand mark on the crankshaft pulley lines up with the crankcase joint and the distributor rotor arm is in line with the number 1 cylinder mark on rim of distributor.

Loosen clamp screw on distributor retainer. Connect a 6 Volt test lamp to terminal 1 of the ignition coil and to ground.

Switch on ignition.

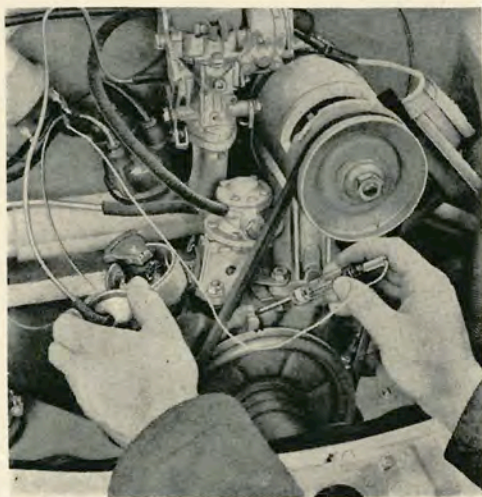

Rotate the distributor clockwise until the contact points are closed and then slowly anti-clockwise until the contact points just start to open and the test lamp comes on.

Tighten the clamping screw of distributor retainer.

Install distributor cap.

The ignition is correctly set if, on cranking the engine slowly clockwise, the test lamp comes on when the left-hand mark on the crankshaft pulley is in line with the crankcase joint. Beforehand, the engine should be turned back anti-clockwise approximately a quarter of a revolution to take up the play in the distributor drive.

Checking the spark plugs

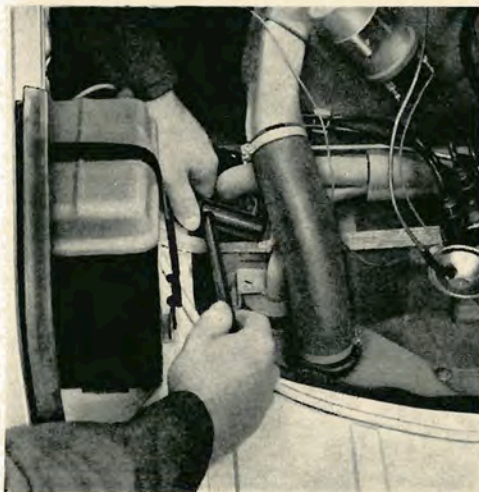

The appearance of the electrodes and insulation gives valuable information on the adjustment and condition of the engine:

- medium grey — correct carburetor adjustment and proper performance of spark plug
- black — mixture too rich
- light grey — mixture too lean
- oiled up — failure of spark plug or piston ring blow-by

The spark plugs have an average service life of approximately 20,000 km (12,000 miles) and should, therefore, be replaced in time. To prevent any breakdowns in the ignition system, the spark plugs should be removed every 10,000 km (6,000 miles) and checked. Deposits can easily be removed with a brush and a chip of wood. Moreover, the insulator should be clean and dry on the outside in order to avoid short circuit and tracking. If necessary, adjust the spark plug gap to 0.7 mm.

Do not omit the gasket when screwing in the spark plug. Do not overtighten the spark plugs.

Checking the compression

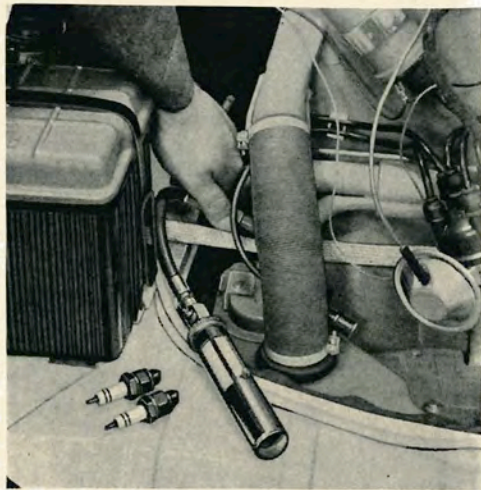

The compression is checked by inserting a suitable gauge into the spark plug hole when the engine is warm. All the spark plugs should be removed when checking the pressure. The accelerator pedal is then depressed fully and the engine turned over with the starter until the gauge reading shows no further change.

The pressure should be at least 6.5 kg/cm^2 (92 psi). It is important that only a good accurate instrument is used and a good seal obtained between instrument and spark plug seat.

Adjusting the valves

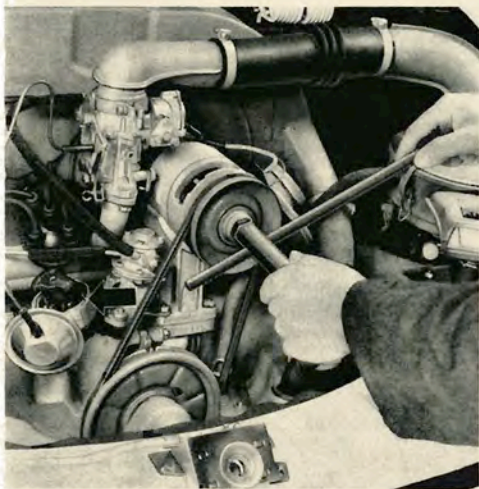

The valves must only be adjusted when the engine is cold or slightly warm. The valve clearance is 0.10 mm (.004") for the intake and exhaust valves.

When adjusting, both valves must be closed, i. e. the piston of the cylinder concerned must be at TDC. on the compression stroke. The arrangement of the cylinders can be seen by the numbers 1 to 4 on the engine cover plates. Valve adjustment is carried out in the following sequence: cylinders 1, 2, 3, 4.

Remove distributor cap.

Turn the engine until the rotor arm points to the No. 1 cylinder mark on the rim of the distributor.

Remove cylinder head cover.

Loosen the adjusting screw lock nuts for the valves of No. 1 cylinder.

Adjust valve clearance with a feeler gauge.

Hold the adjusting screws and tighten the lock nuts.

To adjust the valves for cylinders No. 2, 3 and 4, turn the engine further anti-clockwise until the rotor arm is 90° offset each time.

Adjusting the carburetor

Each carburetor is checked at the factory and adjusted to the engine. Special knowledge and experience is required to check and adjust the carburetor with automatic choke and to carry out repairs to the accelerator pump. For this reason, these operations should only be carried out by a VW workshop. Do not alter the adjustment by replacing the jets by other than the prescribed sizes. This would be detrimental under normal operating conditions and is not permissible.

Only the idling speed may require occasional readjustment. The adjustment must be carried out when the engine is at operating temperature. Check that the idling adjusting screw is no longer resting on the fast idle cam of the automatic choke.

Turn the idling adjusting screw until an idling speed of 700—800 rpm has been attained (1).

Turn the volume control screw clockwise until the engine speed begins to drop. Then give it a $\frac{1}{4}$ to $\frac{1}{3}$ of a turn in an anti-clockwise direction (2).

Re-adjust the idling adjusting screw (1).

The adjustment is correct if the engine does not stall when the throttle is either suddenly opened or shut.

Poor idling may also be the result of damaged gaskets, loose intake manifold flanges, faulty ignition or leaky valves.

1

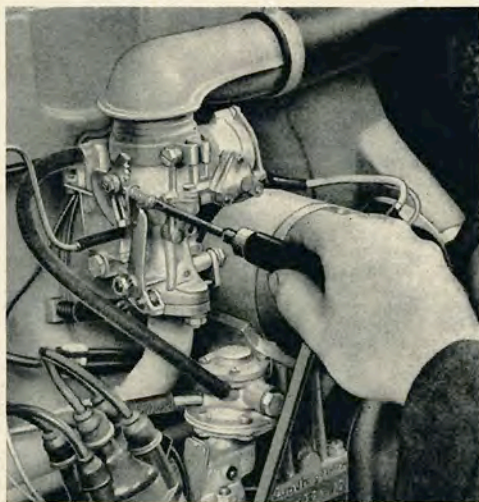

2

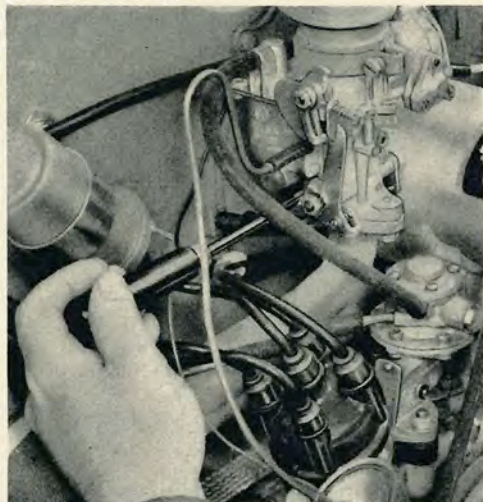

Checking clutch pedal free-play

Easy gear shifting and complete transmission of engine power to gears and wheels can only be guaranteed if the clutch is adjusted as specified.

Measured at the clutch pedal, this free-play should be between 10 and 20 mm / .4 and .8 in. (a). The clearance is adjusted with a wing nut on the cable end.

Ensure that the two lugs on the wing nut engage in the slots in the clutch operating lever.

After adjusting, depress the clutch pedal several times and recheck pedal free-play.

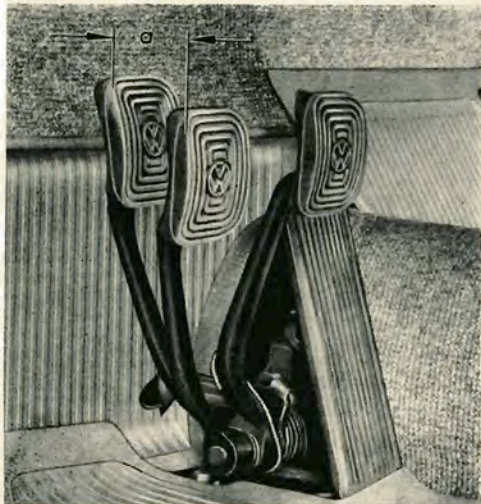

The front wheel toe-in and camber

can only be checked properly in the workshop. When the vehicle is unladen, the camber should be $30' \pm 15'$ and the toe-in 2 to 4,5 mm. Excessive deviations from these values will have a detrimental effect on the riding characteristics of the vehicle and on the service life of the tires.

Checking the steering

The steering should not have an excessive amount of play in the straight ahead position. Moreover, the wheels must self-center after cornering.

To check the steering, move the steering wheel lightly to and fro until resistance is felt in both directions. The steering gear is correctly adjusted if there is not more than 25 mm (1") play when measured at the steering wheel circumference.

Adjustments to the steering require special experience as well as special tools, and these operations should be carried out in a VW workshop only.

Checking and adjusting brakes

As a result of natural wear, the clearance between brake shoes and drum will increase during the course of time. If the foot brake pedal travel becomes excessive, the brakes must be relined or re-adjusted.

The brake lining wear must be checked through the inspection hole in the brake drums every 10,000 km (6,000 miles). The brake lining thickness must not be less than 2.5 mm (.1"). Moreover, check the brake system for damage, leaks and corrosion. Damaged brake lines must be replaced immediately.

Spongy brake pedal travel indicates the presence of air in the system. Before bleeding the brakes, check the brake fluid level in the reservoir behind the spare wheel. The reservoir should be at least three quarters full. Only use Genuine VW Brake Fluid or Lockheed Brake Fluid when topping up.

Handle the brake fluid carefully as it can damage the paintwork severely.

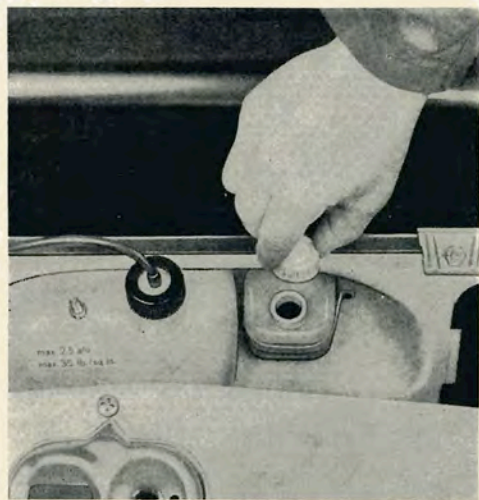

Adjusting the foot brake

The brake shoes are adjusted individually on all four wheels. Before and after adjustment, completely depress the brake pedal several times to allow the brake shoes to centralize in the drums. When adjusting the rear brakes, the hand brake must be released.

Remove wheel cap.

Jack up a wheel and turn it until the hole in the brake drum is in line with one of the two adjusting nuts.

Turn the adjusting nut with a screwdriver in the direction indicated by the arrow until a slight drag is noted when wheel is turned by hand.

Repeat procedure on the other adjusting nut. Note that the two nuts turn in opposite directions.

Back off the adjusting nuts 3 to 4 teeth until the wheel rotates freely.

Install wheel cap and make sure that it is correctly seated.

Repeat the above operations on the other wheels.

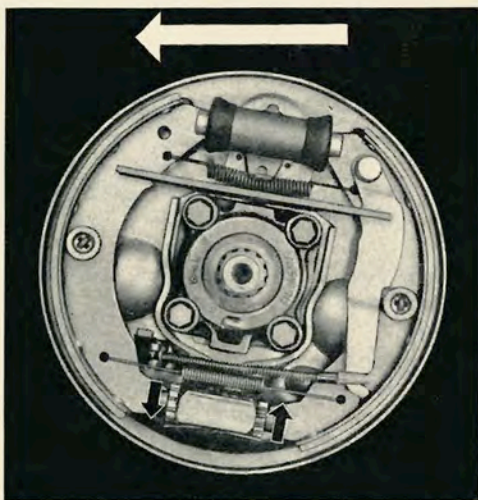
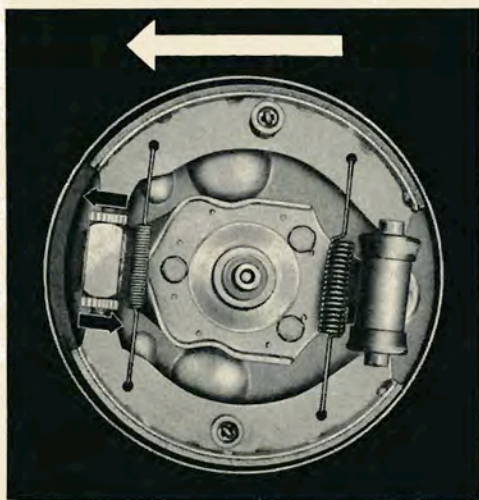

Bleeding the brakes

When bleeding the brakes, always begin with the wheel which is farthest away from the master brake cylinder. The sequence for cars with left-hand drive is as follows: Right and left rear wheels, then the right front and finally the left front wheel.

Remove rubber cap of the bleeder valve and attach bleeder hose.

Submerge the free end of the hose in a glass container partially filled with brake fluid. The end of the drain hose should, if possible, be above the level of the bleeder valve.

Slacken the bleeder valve between $\frac{1}{2}$ and 1 turn using a 7 mm wrench.

Pump the brake pedal several times until the air bubbles cease to appear.

Keep the brake pedal in the fully depressed position until the bleeder valve is closed.

Remove the bleeder hose and replace rubber cap.

Repeat the above operations on the other wheels. Make sure that the brake fluid level in the reservoir is sufficient to ensure that air is not drawn in. After bleeding the complete system, check the brake fluid level and top up if necessary.

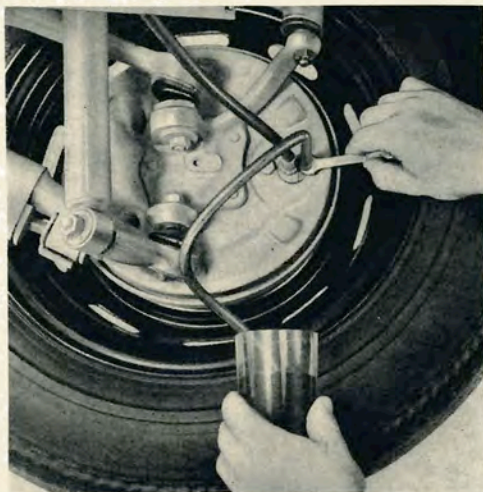

Adjusting hand brake

The hand brake is adjusted at the hand brake lever. The adjusting nuts are accessible through slots in the side of the cover.

Raise both rear wheels.

Back off lock nuts and tighten the adjusting nuts evenly until the rear wheels are just free to turn when the hand brake is released.

Apply hand brake. At the fourth notch it should not be possible to turn the wheels by hand. The compensating lever under the adjusting nuts should be horizontal when the hand brake is on.

Lock the adjusting nuts carefully again.

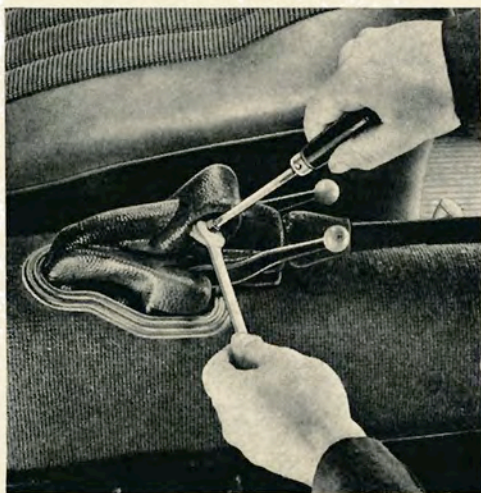

Checking the battery

Ready starting of the engine depends upon the condition of the battery. It should, therefore, be checked and maintained regularly. The battery cover can be removed after releasing the strap.

The acid level must always be slightly above the plates. The acid level has to be adjusted in accordance with the acid level mark. Depending on the type of battery, either the lower edge of the insert or the bar above the plates must just be covered. Losses by evaporation can be replenished by adding distilled water. Do not add acid unless some of the electrolyte has been spilled. If the level is too high the acid can boil over and cause damage. For this reason exercise care when topping up.

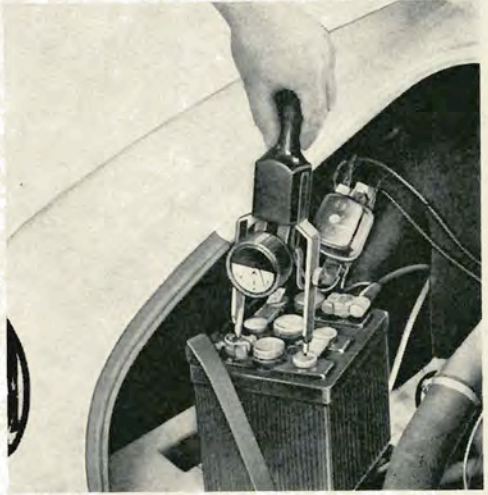

The battery should be checked with a cell tester. This is a voltmeter in parallel with a heavy resistance. The voltage of each cell should not fall below 1.6 Volts while the reading is being taken (10—15 seconds). Otherwise the cell is discharged or defective. The normal voltage is 2 Volts.

The battery poles should be cleaned with a clean cloth, or, if badly corroded, with a stiff brush. The battery poles and cable terminals should be coated with grease. Make sure that the battery is correctly grounded.

The state of charge of the battery can be checked with a hydrometer. The specific gravity of the acid will increase with the charging of the battery. The gravity can be read from a scale.

Battery fully charged	1.285 = 32° Bé
Battery semi-charged	1.20 = 24° Bé
Battery discharged	1.12 = 16° Bé

When laying your vehicle up for a prolonged period, it is advisable to take the battery to a workshop for storage. A battery which is not in constant use will discharge itself in time and this can result in permanent damage to the plates if the battery is not checked about every 4 weeks and charged as necessary.

Headlight adjustment

When adjusting the headlights, ensure that the tires are inflated to the correct pressure. If a headlight aiming device is not available, proceed as follows:

1 - Headlights with separate reflector and bulb

Position the vehicle on a level surface 5 m. (16 ft. 5 ins.) away from a vertical wall. The rear seat must be loaded with one person or a weight of 70 kg. (154 lbs.).

Draw two crosses with setting lines on the wall to the measurements in sketch 1. The longitudinal center line of the vehicle must be aligned exactly with the centre between the two crosses and at right angles to the wall.

Aim the headlights individually by turning the two slotted screws in the head lamp rim with the beams dimmed. Cover up the second headlight.

The headlights are correctly aimed when the light-dark border line is horizontal on the adjusting line to the left of the cross and the angle on the light-dark border line is exactly on the cross.

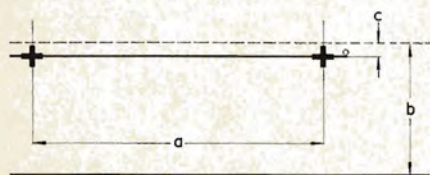

Sketch 1

a - 1240 mm. (48.8")

b - Height of headlight center from floor

c - 50 mm./2" (at a distance of 5 m. from the screen)

A — Lateral aim

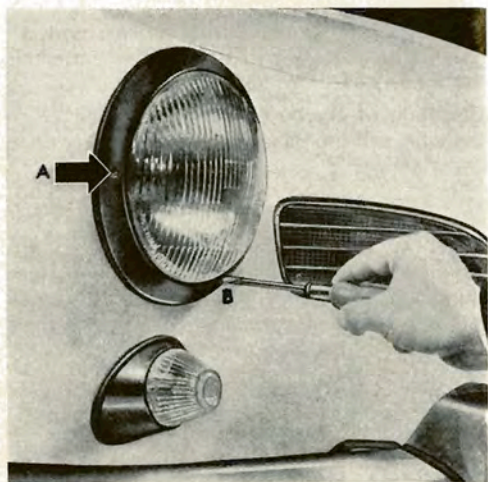

2 - Sealed-Beam Headlights

Position the vehicle on a level surface 7.6 m. (25 ft.) away from a vertical wall. The drivers seat must be loaded with one person or a weight of 70 kg. (154 lbs.).

Draw three setting lines on the wall to the measurements in sketch 2. The longitudinal center line of the vehicle must be aligned with the center between the two vertical lines and and at right angles to the wall.

Aim the headlights individually by turning the two slotted screws in the head lamp rim with low beams switched on. Cover up the second headlight.

The headlights are correctly aimed when the top edge of the high intensity zone is on the horizontal line H and the left edge is 2" to the right of the vertical line V.

B — Vertical aim

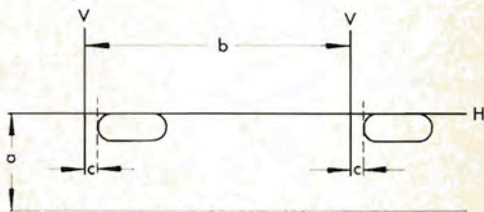
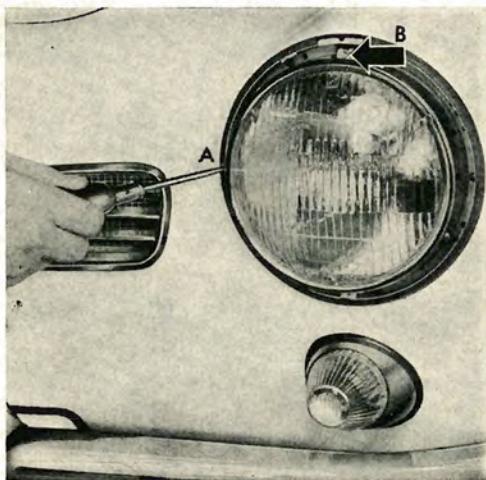

Sketch 2

- a - Height of headlight center from floor
- b - Distance between headlights (48.8")
- c - 2"

Headlight bulb replacement

Loosen screw in the center below the headlight and take the trim ring off.

Loosen the slotted fixing screw at the bottom of the headlight rim and take out the headlight unit. Turn the cap to the left and take the holder out of the reflector. Pull the connector off the bulb base and replace the bulb.

When installing the new lamp, hold it with a clean cloth or paper serviette and not with the bare hand.

The lug in the lamp holder must engage in the notch provided in the reflector.

Install the cap so that the contact strip is on the base of the parking light bulb. Check the headlight settings.



Replacement of Sealed-Beam units

Loosen screw in the center below the headlight and take the trim ring off.

Remove three screws in Sealed-Beam retaining ring and take ring off.

Take Sealed-Beam unit out of support ring and pull cable connector off.

When installing new Sealed-Beam units, ensure that the three glass lugs engage properly in the support ring.

Check headlight settings.

Front turn indicator bulb replacement

Remove two Phillips screws

Take ring and lens off

Replace bulb

When installing, ensure that the rubber seal is located properly

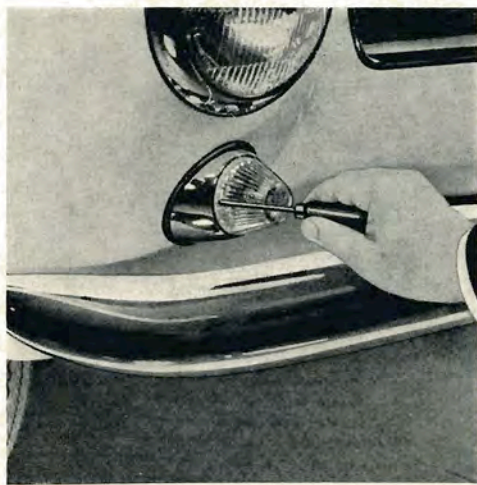

Stop, tail or rear indicator bulb replacement

Remove two Phillips screws

Take lens off

Replace bulb

Arrangement of bulbs:

- Top — Turn indicator lamp
- Center — Stop lamp
- Bottom — Tail lamp

When installing the lens, ensure that the gasket is located properly. Tighten screws evenly but not excessively.

License plate bulb replacement

Open rear hood

Remove screws on each side of lens and take lens out.

Replace bulb.

When installing, ensure that the gasket is located properly.

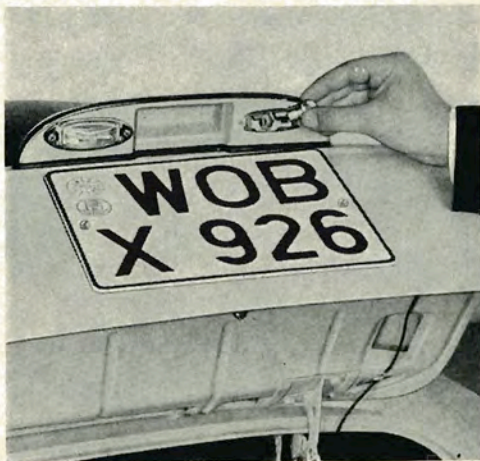
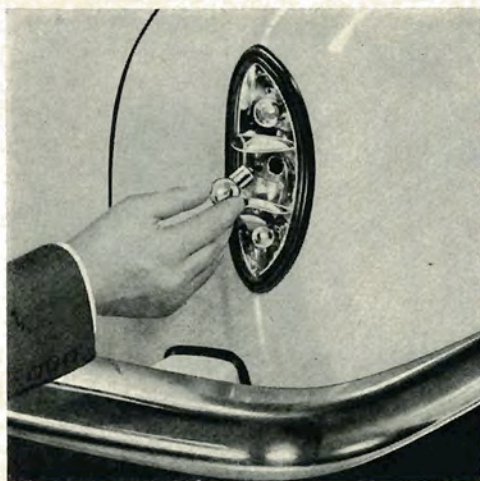

Warning light bulb replacement

The warning lights for oil pressure, generator, turn indicator and high beam and also the instrument lights are accessible after lifting the front hood and folding down the cover at the back of the instrument panel. The bulb holders can be pulled out of their holders easily.

- 1 — Clock light
- 2 — Fuel gauge light
- 3 — Speedometer light
- 4 — High beam warning light
- 5 — Oil pressure warning light
- 6 — Turn indicator warning light
- 7 — Generator warning light

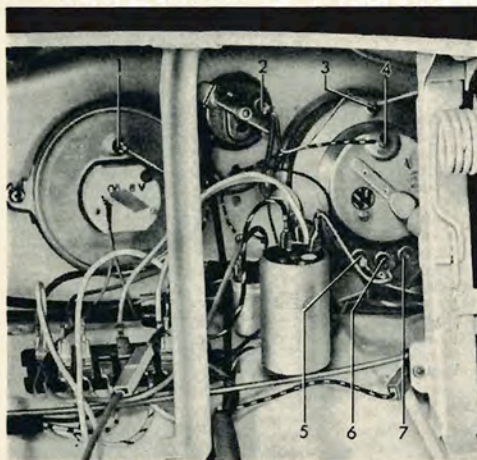

Replacing fuses

The fuse box, with transparent cover, is located under the instrument panel near the steering column. A connector with a fuse is fitted in the cable from the ignition-starter switch to the horn relay.

When a fuse has blown, it is not sufficient merely to replace it with a new one. Inspect the electrical system for evidence of short circuits or other faults which may have caused the fuse to blow.

Under no circumstances use fuses which have been patched up with tin foil or wire as this would be liable to cause severe damage. We suggest that you always carry a few 8 and 16 amp. fuses.

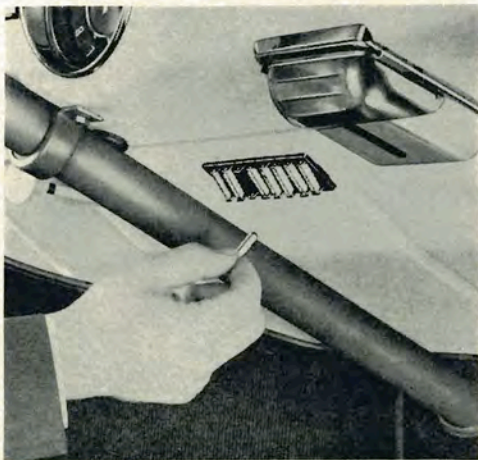

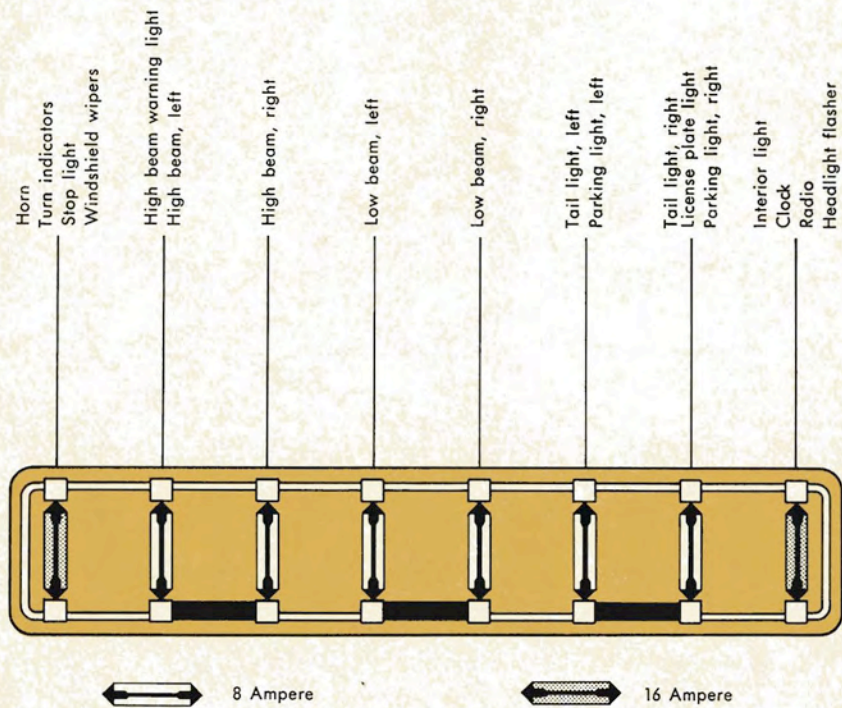

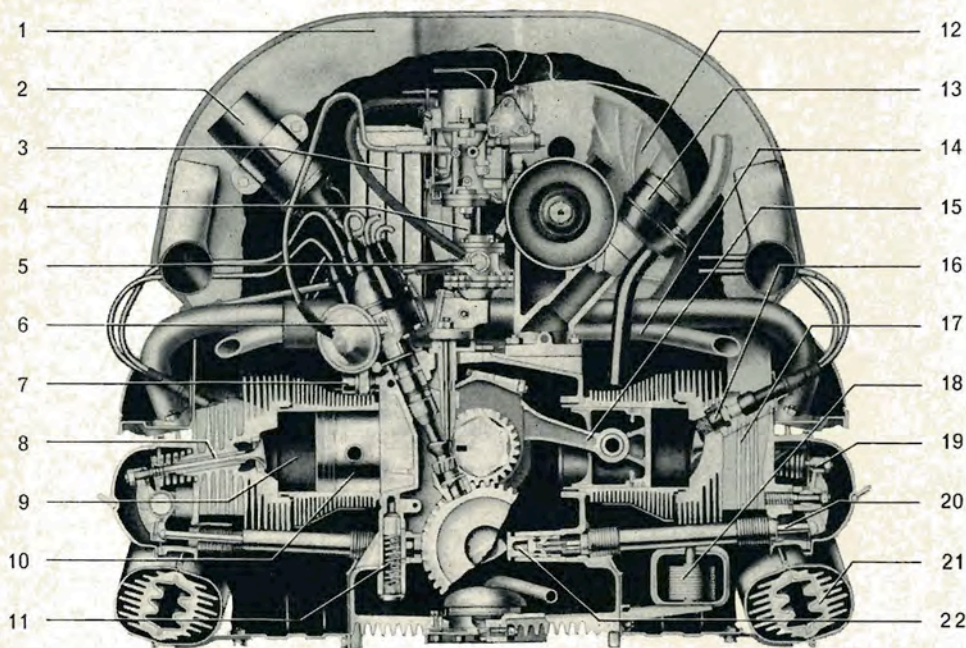

General description

Engine

The engine, located in the rear of the car, is attached by four bolts to the flange of the rubber mounted transmission case. The crankcase is made of a light alloy. Two pairs of cylinders are horizontally opposed. Each pair has a common cylinder head made of light alloy. The overhead valves are located in the cylinder heads and are operated by the camshaft via cam followers, push rods and rocker arms. The short crankshaft runs in four bearings and has induction hardened journals. The camshaft is driven from it by means of helical gears. The connecting rods are fitted with lead-bronze-bearings. The pistons are of light alloy with steel inserts.

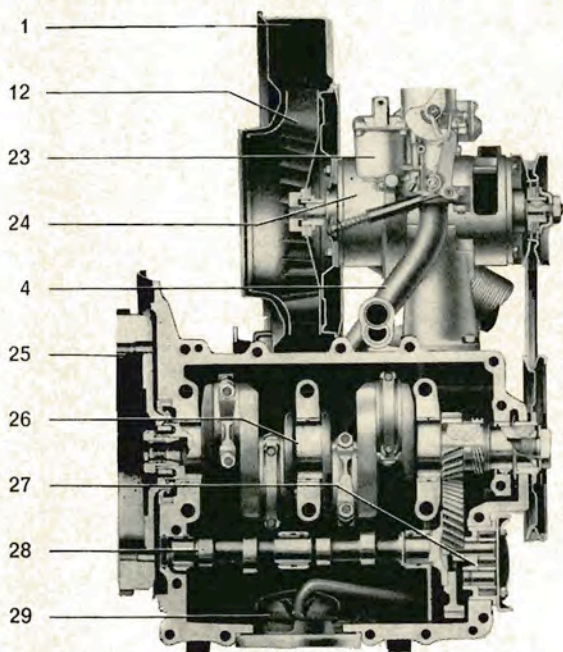

- 1 Fan housing
- 2 Ignition coil
- 3 Oil cooler
- 4 Intake manifold
- 5 Fuel pump
- 6 Distributor
- 7 Oil pressure switch
- 8 Valve
- 9 Cylinder
- 10 Piston
- 11 Oil pressure relief valve
- 12 Fan
- 13 Oil filler and breather
- 14 Pre-heating pipe
- 15 Connecting rod
- 16 Spark plug
- 17 Cylinder head
- 18 Thermostat
- 19 Rocker arm
- 20 Push rod
- 21 Heat exchanger
- 22 Cam follower
- 23 Carburetor
- 24 Generator
- 25 Flywheel
- 26 Crankshaft
- 27 Oil pump
- 28 Camshaft
- 29 Oil strainer

A down-draft carburetor with automatic choke and accelerator pump supplies the fuel-air mixture to the cylinders.

The engine is equipped with battery ignition. The spark advance is controlled automatically by a vacuum mechanism. The generator is driven by a V belt. The generator pulley can be adjusted to alter the V belt tension.

The oil pump of the pressure lubrication system is driven by the camshaft. The oil is drawn from the crankcase via a strainer and forced via an oil cooler to the lubrication points. When the oil is thick, an oil pressure relief valve enables the oil to flow direct to the lubrication points by by-passing the oil cooler.

The engine is cooled by a fan mounted on the generator shaft. The fan sucks in air through an opening in the fan housing and forces it through the fins of the cylinders. The flow of cooling air is regulated by a thermostat and this ensures a constant operating temperature.

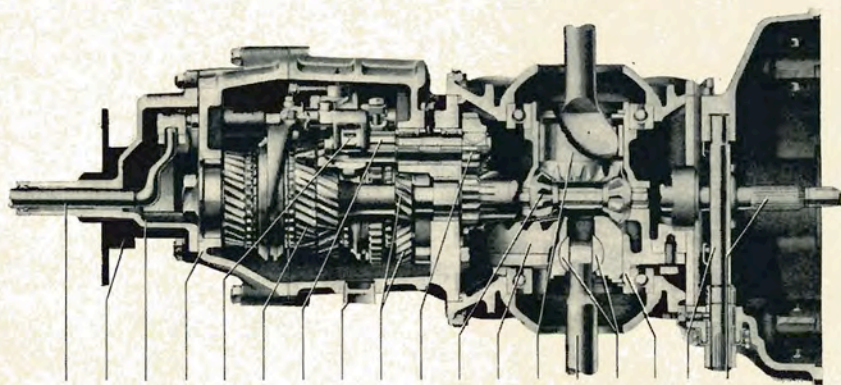
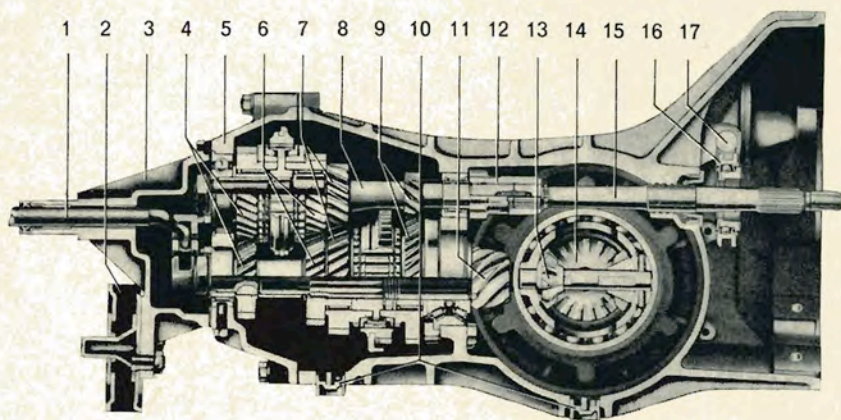

- | | |
|------------------------------|-----------------------------|
| 1 — Transmission shift lever | 14 — Differential side gear |
| 2 — Bonded rubber mounting | 15 — Main drive shaft, rear |
| 3 — Gearshift housing | 16 — Clutch release bearing |
| 4 — 4 th speed | 17 — Clutch operating shaft |
| 5 — Gear carrier | 18 — Reverse sliding gear |
| 6 — 3 rd speed | 19 — Reverse shaft |
| 7 — 2 nd speed | 20 — Oil filler plug |
| 8 — Main drive shaft, front | 21 — Reverse drive gear |
| 9 — 1st speed | 22 — Ring gear |
| 10 — Oil drain plugs | 23 — Rear axle shaft |
| 11 — Drive pinion | 24 — Fulcrum plates |
| 12 — Reverse gear | 25 — Differential housing |
| 13 — Differential pinion | |

Chassis

The frame is of pressed steel. The steel floor of the frame is formed in two pieces. These two pieces are spot-welded together with the channel shaped center section of the frame, the forked rear end of which serves to support the transmission and engine unit.

The gearshift rod, fuel line, and the guide tubes for the hand brake, clutch, throttle, and heating control cables pass through the frame tunnel.

The front suspension is an independent trailing arm type, using torsion bar springs. The front axle is bolted to the front end of the frame and consists of two rigidly joined tubes, which carry the torsion bar springs and the upper and lower arms of the front wheel suspension. A stabilizer is attached to the lower torsion arms.

The roller type steering gear acts on the front wheels via a divided tie rod. A steering damper ensures steering steadiness.

The rear axle is of the swinging half axle design. The rear wheels are independently sprung and have adjustable torsion bars.

Double-acting hydraulic shock absorbers in front and rear prevent excessive rebound.

Transmission and rear axle

Power from the engine is transmitted to the gears via a dry single-plate clutch. The transmission case houses the transmission with four forward speeds, one reverse, and the differential. All the forward gears are synchronized. The gears are helically cut to ensure silent operation. The drive pinion and the ring gear are cut spirally. The two swinging rear axle shafts are pivoted in the differential.

Brakes

The hydraulic foot brakes operate on all wheels, and the handbrake, via cables, on the rear wheels.

Body

The streamlined two-door body is made of pressed steel and electrically welded. It is bolted to the frame. Both window doors can be lowered. Hinged quarter windows ensure draft free ventilation. Both front seats can easily be adjusted while driving.

The luggage compartments are located under the front hood and behind the emergency seat. The lock in the front hood is opened from the driving seat by means of a cable. The fuel tank and spare wheel are also under the front hood.

Heating and ventilation

The fresh air drawn in by the fan is heated in heat exchangers. It is emitted through two defroster vents at the windshield, one defroster vent at the rear window and two controllable outlets each in front and rear foot wells. The heating is regulated by two levers situated beside the driver's seat on the frame tunnel.

The fresh air ventilation is regulated separately for each side by two levers under the instrument panel. The fresh air enters the body via the defroster vents and can thus be mixed with the warm air.

Technical data

Engine

Design	4 Cylinder, 4 stroke, in rear of car
Arrangement of cylinders	Horizontally opposed (Flat four)
Bore	77 mm. (3.031")
Stroke	69 mm. (2.716")
Capacity	1285 c. c. (78.3 cu. in.)
Compression ratio	7.3:1
Valves	Overhead
Valve clearance with engine cold	Intake 0.10 mm (.004") Exhaust 0.10 mm (.004")
Maximum output (SAE)	50 bhp at 4600 rpm
Lubrication	Force feed by gear pump. Oil cooler
Oil capacity	2.5 liters (5.3 U.S. pints, 4.4 Imp. pints)
Fuel delivery	Mechanical fuel pump
Carburetor	Down-draft type, Solex 30 PICT
Cooling system	Air cooling by fan, thermostat controlled
Battery	6 Volts, 66 Ampere hours
Starting motor	Electric, 6 Volts, 0.5 hp
Generator	Voltage regulating, 6 Volts, 180 Watts at 2200 rpm.
Ignition distributor	with vacuum spark advance
Firing order	1 — 4 — 3 — 2
Initial spark advance	7.5° before T.D.C.
Breaker point gap	0.4 mm. (.016")
Spark plugs	14 mm. thread Bosch W 175 T 1 Beru 175/14 Champion L 87 y and plugs of similar values from other manufacturers
Spark plug gap	0.7 mm. (.028")

Clutch

Design	Single plate, dry
Pedal free-play	10 to 20 mm. (.4" — .8")

Transmission

4 Forward speeds, 1 reverse

All forward gears synchronized and silent running.

Gear ratios	First	3.80:1	Third	1.32:1
	Second	2.06:1	Fourth	0.89:1
			Reverse	3.88:1

Rear axle

Power is transmitted through a spiral drive pinion and ring gear, via two swinging shafts to the rear wheels.

Ratio	4.375:1
Oil capacity of transmission	3.0 liters (6.3 U.S. pints, 5.3 Imp. pints)

Chassis

Springs, front	Two torsion bars
rear	Two torsion bars
Shock absorbers	Double acting telescopic type, at front and rear
Steering	Roller steering gear, divided tie rod and hydraulic steering damper
Turns of steering wheel, Lock to lock	2.6
Turning circle	about 11.25 m. (36 ft. 9 ins.)
Wheels	Disc wheels 4 J × 15, drop-center type
Tires	5.60 — 15, tubeless
Inflation pressure	
1 to 2 occupants	Front: 1.1 kg./cm ² Rear: 1.7 kg./cm ² 16 psi 24 psi
fully loaded	Front: 1.2 kg./cm ² Rear: 1.8 kg./cm ² 17 psi 26 psi

For long, high speed motorway trips, the tire pressures should be increased by 0.2 kg/cm² (3 psi) at front and rear.

Wheel base	2400 mm. (94.5 ins.)
Track	Front: 1305 mm. (51.4 ins.) Rear: 1300 mm. (51.2 ins.)
Toe-in (unladen)	2 to 4.5 mm. (.08 ins. to .18 ins.)
Camber (unladen)	30' + 15'
Foot brake	Hydraulic, acting on all wheels
Hand brake	Mechanical, acting on rear wheels

Dimensions and weights

Length	4140 mm. (163.0 ins.)
Width	1634 mm. (64.3 ins.)
Height	1330 mm. (52.4 ins.)
Ground clearance	152 mm. (6.0 ins.)
Kerb weight	830 kg. (1830 lbs.)
Maximum carrying capacity	330 kg. (727 lbs.)
Permissible total weight	1160 kg. (2557 lbs.)
Maximum axle loads	Front 480 kg. (1058 lbs.) Rear 700 kg. (1543 lbs.)

Fuel

Fuel consumption	
according to DIN 70030 . . .	Metric — 8.0 liters per 100 km. U.S. — 29.5 miles per gallon Imp. — 35.0 miles per gallon

(Consumption plus 10 % at half the load and at a steady $\frac{3}{4}$ of top speed 96 kph/60 mph. on level road.)

Fuel rating	87 Octane (Res. F 1)
Oil consumption	0.3—1.0 liter per 1,000 km. (600 miles) 1.0—3.4 U.S. pints per 1,000 miles 0.9—2.8 Imp. pints per 1,000 miles

Refill requirements

Fuel tank	40 liters (10.6 U.S. gall.; 8.8 Imp. gall.)
Engine	2.5 liters (5.3 U.S. pints; 4.4 Imp. pints)
Rear axle and transmission	2.5 liters (5.3 U.S. pints; 4.4 Imp. pints)
Brakes	0.25 liter (0.53 U.S. pint; 0.44 Imp. pint)
Container for windshield washer	approx. 1 liter (1 qt.)
Oil bath air cleaner	0.30 liter (0.63 U.S. pint; 0.53 Imp. pint)

Performance

Maximum and cruising speed	128 kph. (80 mph.)	
Hill-climbing ability	First Speed	42 %
	Second Speed	22 %
	Third Speed	13 %
	Fourth Speed	7.5%

Bulb chart V = Volts, W = Watts

(according to German
Standard DIN 72 601)

Spare Part No.

Headlights	A 6 V 45/40 W	N 17 705 1
Parking lights	HL 6 V 4 W	N 17 717 1
Turn indicator, front	R 6 V 18 W	N 17 731 1
Turn indicator, rear	R 6 V 18 W	N 17 731 1
Stop lights	R 6 V 18 W	N 17 731 1
Tail lights	G 6 V 5 W	N 17 718 1
License plate light	G 6 V 5 W	N 17 718 1
Instrument light and warning lights	J 6 V 1,2 W	N 17 722 1
Interior light	HL 6 V 4 W	N 17 717 1

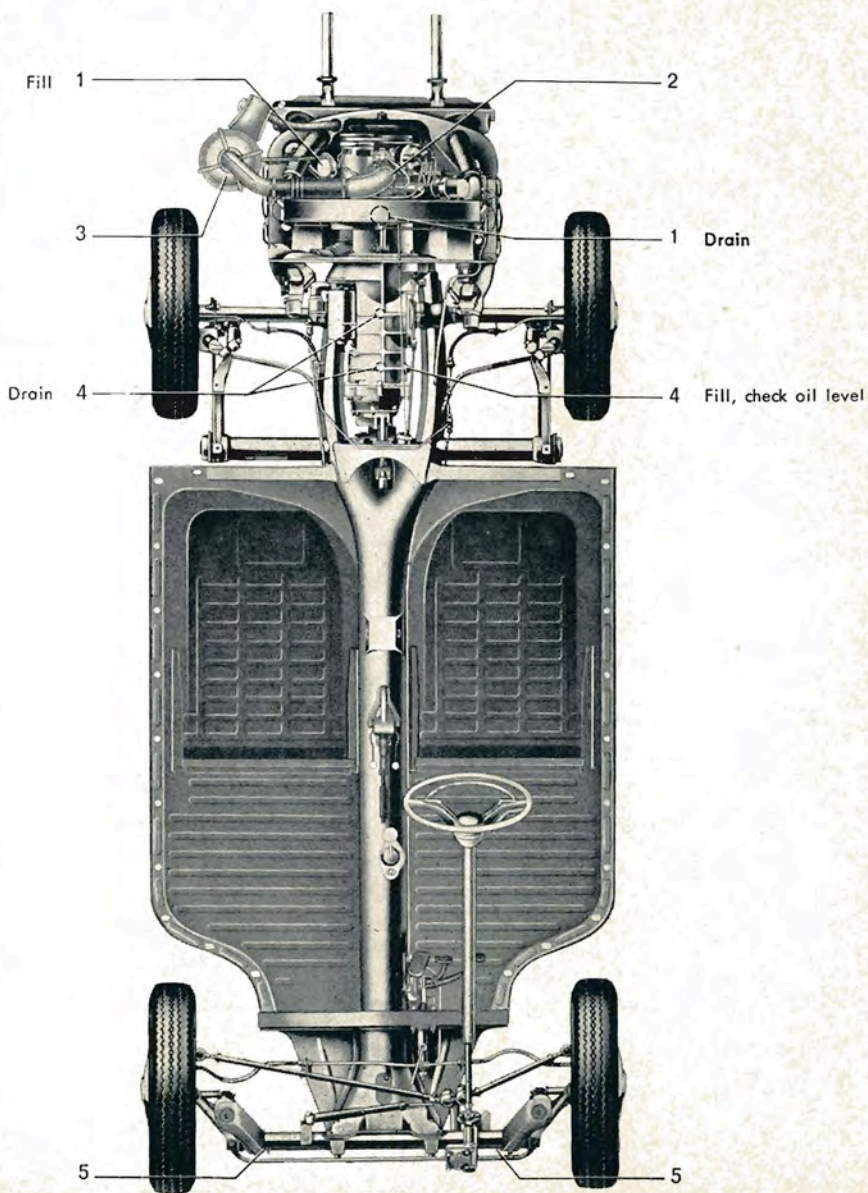

Lubrication chart

500 km. 300 miles	5000 km. 3000 miles	No.	Operation	Every
		1	Engine: Change oil, clean oil strainer, check for leaks.	5 000 km 3000 miles
		2	Lubricate carburetor linkage	
			Check battery, clean and grease terminals	
			Door and hood locks *	
		3	Check air cleaner, clean lower part if necessary	10 000 km 6 000 miles
		4	Rear axle: Check oil level, check for leaks	
		5	Front axle: Lubricate	
		4	Rear axle: Change oil, clean magnetic oil drain plugs, check for leaks.	50000 km 30000 miles

* at least every 3 months.

Lubricants

Lubricant	Lubrication points	Specifications	
		Temperature °C °F	
Engine oil (Approved HD oil for spark ignition engines)	Engine, oil bath air cleaner, carburetor	above 0 32	SAE 30
		below 0 32	SAE 10 W
		below -25 -13	SAE 5 W
Hypoid Oil	Transmission	all the year SAE 90 *	
Universal grease	Door and hood locks	Cold resistant water-repellent high pressure grease	
Lithium grease	Torsion arms, front wheel bearings, breaker arm fiber block in distributor	Multi-purpose grease	

* SAE 80 all the year in countries with arctic climates.

Maintenance chart

500 km. 300 miles	10 000 km. 6 000 miles	Operation	Every
		Check rear axle shaft nuts for tightness.	
		Check tire pressures and tightness of wheel bolts.	
		Check fan belt	10 000 km 6 000 miles
		Clean fuel pump filter	
		Check breaker points and replace if necessary, lubricate distributor, check breaker gap and ignition timing.	
		Adjust valve clearance and fit new cylinder head cover gaskets.	
		Clean spark plugs and check compression pressures.	
		Check rubber valve for crankcase ventilation, check exhaust system for damage.	
		Adjust clutch pedal free-play.	
		Check dust seals on steering joints and tie rod ends and security of tie rods.	
		Check and adjust toe-in.	
		Steering gear: Check and adjust play between roller and worm.	
		Check tire wear, damage and inflation pressures.	
		Check hydraulic brake system for leaks and damage, check brake fluid level and adjust hand foot brakes.	
		Check thickness of brake linings.	
		Check operation of electrical system and adjust headlight alignment.	
		Road test vehicle; check foot and hand brake efficiency. Check and adjust idling and heating.	
		Clean front wheel bearings, fill with grease and adjust.	50 000 km 30 000 miles

Tools and accessories

- 1 Spare fan belt
- 1 Tool roll
- 1 Spare wheel
- 1 Jack
- 1 Wheel cap removal tool
- 1 Combination pliers
- 1 Screwdriver with reversible blade for slotted and Phillips screws
- 1 Open end wrench 8/13 mm.
- 1 Socket wrench for spark plugs, fan pulley nut, wheel bolts
- 1 Socket wrench 14 mm.
- 1 Bar for socket wrench and jack



Index

Accelerator pedal	3
— accelerating	20
Accessories	75
Additives — engine	36
— transmission	37
Air cleaner — checking and cleaning	43
Ash tray	9
Battery — maintenance	56
— care in winter	25
Body — airing	33
— description	67
Brakes — adjusting	53
— application	21
— bleeding	54
— care in winter	26
— checking	52
— description	67
Brake pedal	3
Breaking-in	18
Bulb chart	71
Camber	70
— adjustment	51
Carburetor adjusting	50
— type	68
Care of the car	30
Chassis — care in winter	25
— description	67
— lubrication	38
— number	79
Chromium-plated parts — care	32
Climbing ability	71
Clutch — design	69
— pedal	3
— pedal free-play	51
Cold weather hints	24
Compression — checking	48
— ratio of engine	68
Contact breaker points — setting	45
— cleaning	44
Controls and instruments	3

Convertible — care of top	32	Front wheel bearings — lubrication	38
— lubrication of linkage	40	Fuel consumption	70
— opening and closing top	12/13	— delivery	68
Cooling of engine	64	— filter-cleaning	44
Description — general	64	— gauge	14
Dimensions — overall	70	— capacity	14/70
Dimming — headlights	3	— reserve	14
Dipstick	15	Fuse box	62
Distributor	68	Fuses — replacing	62
— lubrication	45	Gear lever	3
Doors	5	— shifting	18
— care of weather strips	33	— on gradients	18
— inside handle	3	Generator	68
— lubrication points	39	Ground clearance	70
— locks frozen	26	Hand brake — adjusting	54
Driving down-hill	21	— description	67
Economy	20	Headlights — aiming	58
Engine — compartment	11	— changing bulb	60
— description	64	— flasher	6
— design	68	Heating — description	67
— lubrication (oil change)	68	— operation	24
— number	79	Hood lock — convertible	10
— sectional view	64	— knob	3
— technical data	68	Horn half-ring	3
Engine oil — change in winter	25	Identification plate	79
— change and capacities	34/70	Idling — checking and adjusting	50
— oil strainer	35	Ignition — timing	46
— type	34	Instrument light	8
Firing order	68	Interior light	8
Flashing indicator bulb — replacement	60	Jack — operation	28
Flashing indicator switch	6	Keys	4
Foot brake — adjusting	54	Leatherette — care of	33
— bleeding	55	License plate light — replacing bulb	61
— description	67	Lighting	8
Front axle — description	67	Lubricants	73
— lubrication	38	Lubrication service	34
— technical data	69	Lubrication chart	73
Front seats — adjustment	5	Luggage compartments	10
		Maintenance service	41
		Maintenance chart	74

Maximum output	68	Tail light — replacing bulb	60
Maximum speed	71	Technical data	68
Oil consumption	70	Tires — inflation pressure	15/69
Oil level — engine	15	— maintenance	27
— dipstick	15	— M + S tires	26
— transmission	37	— size	69
Operating instructions	4	— wear	27
Paintwork — preservation	31	Toe-in	70
— polishing	31	— adjusting	51
Parking your car	22	Tools	75
Practical driving	18	Towing	23
Ratios — rear axle	69	Track	70
— transmission	69	Transmission — description	67
Rear axle — description	67	— oil change and capacity 37/70	
— technical data	69	— sectional view	60
Rear view mirror	6	— oil change in winter	25
Reverse gear	18	Turning circle	69
Safety belts	13	Type of fuel	17
Seat adjustment	5	Upholstery — cleaning	32
Sealed-Beam adjustment	59	Valves — adjusting	49
Shock absorbers — design	69	— arrangement	68
Snow chains	26	— clearance	68
Spare wheel	27	V-belt — checking and adjusting	42
Spark plugs — checking and cleaning	47	Warning lights — replacement	62
— gap	47/68	— flasher	6
— removal	47	— high beam	3
Speedometer	3	— generator and cooling	17
Speed ranges	18/19	— oil pressure	17
Spots — removal	32	Washing your car	30
Starting the engine	16	Weights	70
Starting motor	68	Wheel base	70
Steering — checking	53	Wheels — balancing	27
— type	69	— changing	28
Stop light — bulb replacement	61	— rim size	69
— checking	14	Windows — cleaning	33
Sun visors	6	— regulator handle	3
Suspension — front	69	— weather strips	33
— rear	69	Windshield wiper	3/7
		— washer	7

Identification plate, chassis and engine numbers. The model designation and the chassis and engine numbers are entered in the vehicle documents. The police or Traffic Department attach much importance to these details.

The identification plate

is found behind the spare wheel, underneath the front hood.



The chassis number

is found on the frame tunnel under the emergency seat.



The engine number

is on the crankcase flange below the generator support.

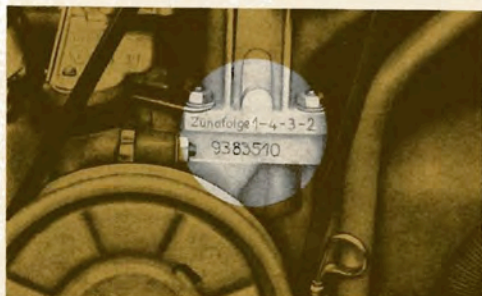

© 1965 Volkswagenwerk Aktiengesellschaft

May not be reproduced or translated in whole or in part without the written consent of Volkswagenwerk.

Specifications subject to alteration without notice.

All rights reserved.





english