

# VOLKSWAGEN 1200



# VOLKSWAGEN 1200

Downs

## Instruction Manual Sedan and Convertible

August 1963 Edition

VOLKSWAGENWERK AG · WOLFSBURG · GERMANY

488 8635  
Don KULHANEK

## Tools and Accessories

- 1 Spare Fan Belt
- 1 Tool Roll
- 1 Spare Tire and Wheel, complete
- 1 Jack
- 1 Hub Cap Removal Tool
- 1 Combination Pliers
- 1 Screwdriver with double-ended blade  
for slotted and Phillips screws
- 1 Open End Wrench 8/13 mm.
- 1 Socket Wrench for Spark Plugs, Fan Pulley Nut, Wheel Bolts
- 1 Socket Wrench 14 mm.
- 1 Bar for Socket Wrench and Jack

© 1963 Volkswagenwerk Aktiengesellschaft

May not be reproduced or translated in whole  
or in part without the written consent of  
Volkswagenwerk.

Specification subject to alteration without notice.





Introduction . . . . .	5
Controls and Instruments . . . . .	6
Operating Instructions . . . . .	9
Practical Driving . . . . .	26
Cold Weather Hints . . . . .	32
Lubrication . . . . .	35
Wheels and Tires . . . . .	43
Care of the Car . . . . .	46
Maintenance . . . . .	53
General Description . . . . .	75
Technical Data . . . . .	78
Bulb Chart . . . . .	81
Lubrication Chart . . . . .	83
Maintenance Chart . . . . .	84
Index . . . . .	85
Sectional View of Volkswagen . . . . .	88

**W**e are sure that the excellent performance and economical operation of your Volkswagen 1200 will justify the confidence you placed in our firm when purchasing this car.

This Manual sets out in full the information necessary for the proper operation, care and general maintenance of your car. In addition, interesting specification details have been included to familiarize you with the construction and mechanical details of this fine piece of mechanism.

No effort has been spared to produce an efficient and reliable automobile. This Instruction Manual can help you obtain lasting satisfaction in the operation of your VW. All information contained in this handbook is based on the actual experience of many years.

In order to maintain maximum efficiency, we particularly stress the importance of following the recommendations set out in this manual. The intimate knowledge obtained by studying this Manual will assure you of the utmost service and satisfaction from your VW.

Regular attention to proper lubrication and maintenance of your car is important. An extensive network of VW Dealers exists throughout the world, and you will readily recognize such stations by the familiar blue VW SERVICE sign.

These Dealers are in constant contact with the Volkswagenwerk through our field engineers, thus providing skillful and speedy execution of any job to be done. You'll enjoy many more miles of trouble-free driving by giving your VW just ordinary care.

All experienced car owners know the value of preventive maintenance. The efforts in regard to care and maintenance will be amply rewarded in the long run.

Happy motoring

**VOLKSWAGENWERK AG**

# CONTROLS AND INSTRUMENTS



## The first thing

you must do is become familiar with the controls and instruments of your new Volkswagen. Sit behind the wheel, make yourself comfortable, and get acquainted with all the various levers, switches, and controls. Some of the features you may already know. Check your present knowledge against this complete list.

### INSTRUMENTS:

Speedometer with mileage recorder . . . . .	5
Warning light - Blue - Headlight high beam	7
Warning light - Red - Generator and cooling	4
Warning light - Green - Low oil pressure . . . . .	8
Warning light - Green - Flashing indicators (dual arrow) . . . . .	6
Fuel gauge . . . . .	21

### FOOT CONTROLS:

Headlight dimmer switch . . . . .	17
Clutch pedal . . . . .	18
Brake pedal . . . . .	19
Accelerator pedal . . . . .	20

### HAND CONTROLS:

Steering / ignition lock . . . . .	9
Headlight and instrument light switch . . . . .	10
Windshield wiper and washer switch . . . . .	12
Gear lever . . . . .	24
Hand brake lever . . . . .	22
Heating control . . . . .	23
Horn lever . . . . .	16
Flashing indicator lever . . . . .	3
Front hood lock control . . . . .	15
Inside door handle . . . . .	13
Window regulator handle . . . . .	14
Vent wing handle release button . . . . .	2
Vent wing handle . . . . .	1
Ash tray . . . . .	11



In the papers which come with your car you will find details regarding the model, year of construction, and chassis and engine numbers. The Police or Traffic Department will check as to whether the information on the papers is identical with that on your car.

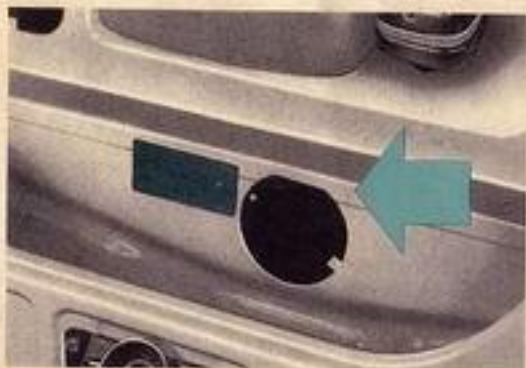

#### **The Identification Plate**

is found behind the spare wheel, underneath the front hood.

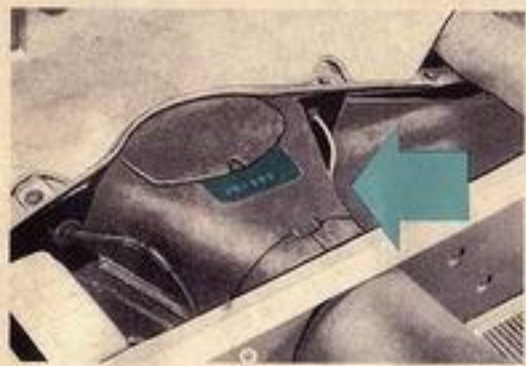

#### **The Chassis Number**

is found on the backbone of the chassis, underneath the rear seat.

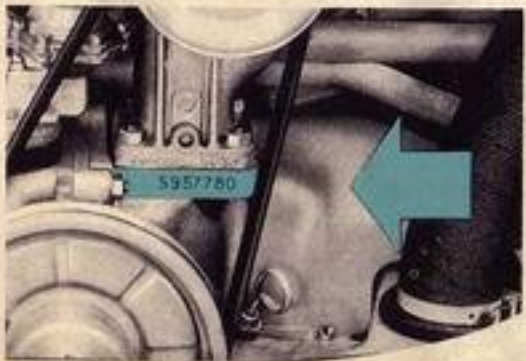

#### **The Engine Number**

is on the crankcase flange for the generator support.

#### **The Vehicle Keys**

You will receive a key for the door lock and one for the steering-ignition lock. On vehicles without the steering-ignition lock, only one key is required to open the door and operate the starter. It is advisable to make a note of the key numbers and keep it with the vehicle documents. If a key is lost, you can then quote the number when ordering a replacement from your VW Dealer.

# OPERATING INSTRUCTIONS

Before you drive away please check

engine oil level

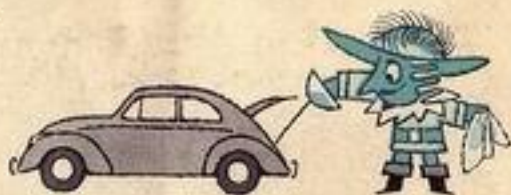

fan belt tension

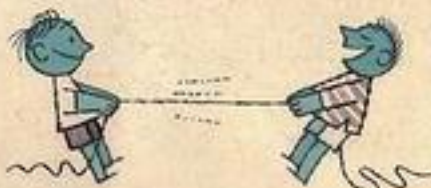

quantity of fuel in the tank



tire pressures



efficiency of brakes

position of driving mirrors



and, if driving in fog or at night, the exterior lights

## Engine Oil Level

The oil level can only be checked with the engine at rest. The oil level is satisfactory when it is between the two marks on the oil dipstick, but it should never be permitted to drop below the lower mark. To make an accurate check, it is best to wipe the dipstick with a clean rag beforehand. Should it become necessary to add oil please remember the following hints: Most oils marketed at present contain chemical ingredients to improve their lubricating qualities. However, oils of different origin behave differently when used as engine lubricants and should, therefore, not be mixed.

**Select an HD oil from among the well-known and dependable brands right at the beginning, and stick to it.**

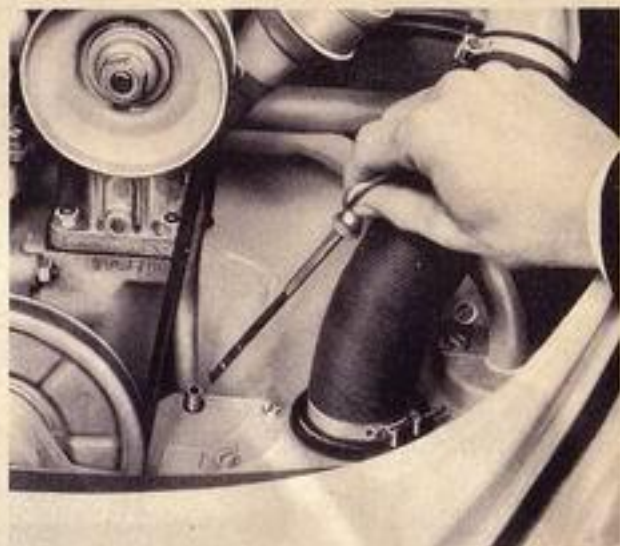

Further hints regarding engine oil changes are given in the sections "Cold Weather Hints" and "Lubrication" on pages 32 and 35-37.

## Fan Belt

The V-belt drives the generator and the engine fan. **Perfect condition and correct tension ensure long belt life and adequate cooling of the engine.**

Checking is very simple:

The belt, when pressed with the thumb at mid-point, should yield:

$$a = 1.5 \text{ cm. (.6")}$$

If you find any signs of wear, such as frayed edges, see your VW Dealer.



Even though the belt, when properly tensioned, has a long service life, a spare should always be carried to meet any emergency.

The adjustment or replacement of the fan belt is described on page 54.

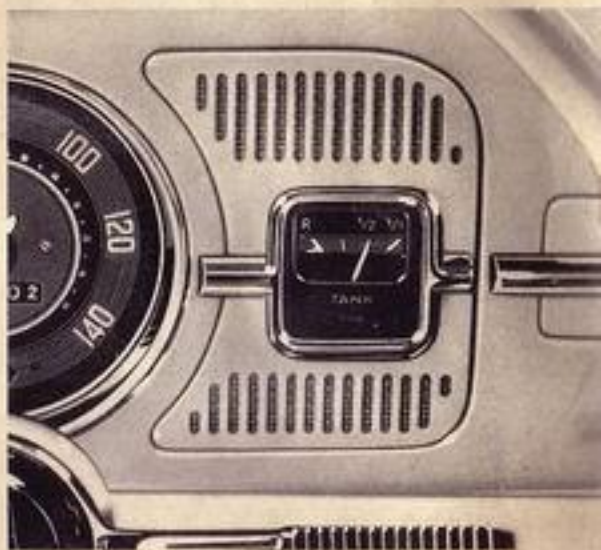

### **The Fuel Tank**

has a capacity of 40 liters (10.6 U.S., 8.8 Imp. gallons) which is sufficient for over 500 kilometers (300 miles). The fuel gauge on the instrument panel shows the actual amount of fuel in the tank. When the needle is on "R" (Reserve) it is time to refuel at the next opportunity. The 5 liters remaining in the tank will last for about 60 kilometers (37 miles).

The choice of fuel type and brand is left entirely to you. The VW engine is so designed that it will run satisfactorily on all normal reputable fuels. All regular and premium mixtures are distinguished by their consistent composition, adequate anti-knock properties and freedom from harmful ingredients.

The fuel tank filler is under the front hood which is opened by means of the knob below the instrument panel.

## The Tires

deserve your special attention. A special section deals with the care of the tires on pages 43-45. The riding comfort and the road-holding of your Volkswagen will greatly depend on their condition. Maintaining correct tire pressures and avoiding driving abuse are the most important factors in obtaining maximum tire life. At least once a week, check that the tires are correctly inflated, using a reliable tire gauge.



Here are the recommended pressures:  
High speed driving conditions on long trips:

front 1.2 kg./sq. cm. (17 lbs./sq. in.)  
rear 1.7 kg./sq. cm. (24 lbs./sq. in.)

Normal conditions:

Car occupied by 1 or 2 persons  
front 1.1 kg./sq. cm. (16 lbs./sq. in.)  
rear 1.4 kg./sq. cm. (20 lbs./sq. in.)

Car occupied by 3 to 5 persons  
front 1.2 kg./sq. cm. (17 lbs./sq. in.)  
rear 1.7 kg./sq. cm. (24 lbs./sq. in.)

## The Brakes

should be checked while the car is in motion before starting out on a trip to make sure they are in good working order.

The section "Apply the brakes gently" on page 16 deals with the correct application of brakes under various circumstances.

## Good Lights

are the first requirement for safe night driving. The three positions of the light switch are as follows:

- Fully pushed in           – Off
- Pulled out to first stop – Parking light, tail and license plate lights
- Fully pulled out           – Headlight high or low beams (depending on position of foot dimmer switch), tail and license plate lights.

When the lighting switch knob is pulled out to either the first or second stop, the instrument light is automatically turned on. By turning the knob, a variable degree of instrument lighting is obtained, turning the knob to extreme left turns out the light entirely.

When checking the lighting system, do not forget the two stop lights which should light up when depressing the brake pedal with the ignition turned on.



### Starting the Engine

The ignition and starter are switched on, one after the other, by means of the combined starter-ignition switch. As starter operation stresses the battery heavily, other big current users, such as the headlights, windshield wiper and radio, should not be switched on when starting. Make sure, also, that the gear shift lever is in neutral.

First switch on the ignition by turning the key to the right until the red and green warning lights in the speedometer come on. Then operate the starter without delay by turning the key further to the right.

**At temperatures above freezing point** or when the engine is still warm, depress the accelerator pedal slightly while operating the starter. Only when the engine is very warm, should the accelerator pedal be fully depressed.

**At temperatures below freezing point** and when the engine is cold, depress the accelerator pedal fully and then release it before switching on the ignition. This enables the automatic choke device to close the choke valve. As the engine and transmission oils tend to become thick when cold, you should also declutch when starting so that the starter motor only has to turn the engine.

As soon as the engine starts, release the ignition key so that the starter is switched off. You can then drive off straight away as the choke valve opens automatically when the engine warms up and regulates the idling speed to suit the engine temperature. Do not race the engine when it is completely cold.

If the engine does not start within the first 10 seconds, pause for about the same length of time to rest the battery before repeating the starter operation. The ignition will have to be switched off first and then on again as a non-repeat lock in the switch prevents the starter from being operated repeatedly when the ignition is on and thus being damaged by the engine when it is running. The starting procedure should not be interrupted if the engine is heard to fire a few times without starting.

### **Caution**

Be careful when starting the engine in the garage. Keep the doors and windows open so that the exhaust fumes, which contain the invisible but very dangerous carbon monoxide gas, can escape.

### **Driving Off**

is extremely easy, if you observe the following points:

- 1 - Depress the clutch pedal as far as possible. Keep it in that position.**
- 2 - Shift to the first gear. Release the hand brake.**
- 3 - Engage the clutch by allowing the pedal to return slowly, and simultaneously depressing the accelerator pedal. The car will start to move forward.**
- 4 - Gradually increase the pressure on the accelerator pedal and remove your foot from the clutch pedal, as the clutch is now fully engaged.**

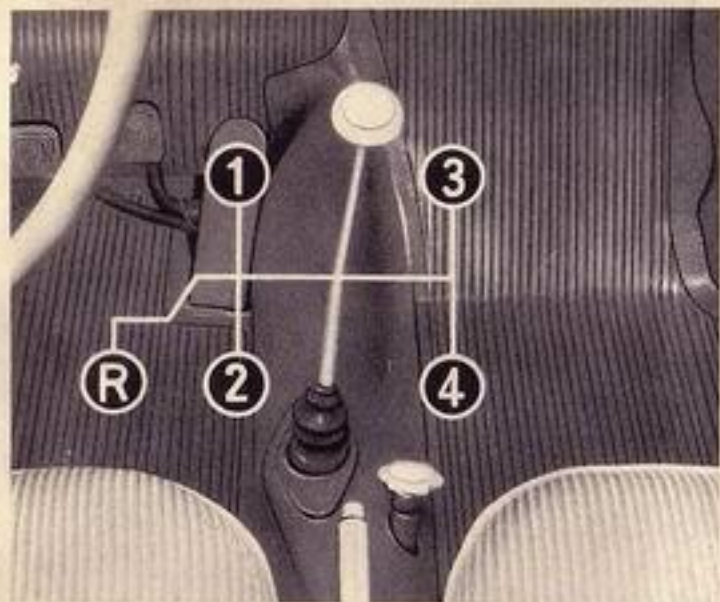

Shifting to second gear is equally simple

- 1 - Take your foot off the accelerator pedal, simultaneously depressing the clutch pedal.**
- 2 - Shift gear lever into second position.**
- 3 - Engage the clutch gently by gradually taking your foot off the pedal, and at the same time depressing the accelerator pedal.**

You now know how to "shift gears", and may at will shift to third and fourth positions. As you have noticed the accelerator and clutch pedals are operated simultaneously, but in opposite directions. It is the coordination of these operations that brings skill in shifting gears.

To shift to **reverse gear**, which should be done only when the vehicle is stationary, first depress the gear lever and then move it to the left and to the rear. A locking device prevents unintentional shifting.

### **Shifting to a Lower Gear**

This is what you should do in dense city traffic, or with sharp turns ahead of you, or when driving uphill.

- 1 - Release accelerator pedal and depress clutch pedal.**
- 2 - Shift to the next lower gear.**
- 3 - Release clutch pedal and depress accelerator pedal simultaneously.**



Of course, this takes less time to do than it does to describe. We do not want to bore you with a technical discourse, but it may be of interest to you to know that, when changing down, the synchromesh device ensures quiet meshing of the gears, as the lower gear is synchronized so that both gears are turning at the same speed.

When shifting gears, it is absolutely essential to depress the clutch pedal fully. Incomplete declutching makes gear shifting difficult and leads to rapid wear of the synchronizer stop rings.

In order to save transmission and engine from damage shift down from

**4th to 3rd between 75 and 40 kph. (45 and 25 mph.)**

**3rd to 2nd between 50 and 25 kph. (30 and 15 mph.) only.**

The 1st gear is only used for moving off, driving at walking pace, or on very steep inclines.

After a little practice, you will take pleasure in the correct shifting of the gears and obtain the utmost satisfaction from the efficient performance of your new Volkswagen. Under no circumstances should you be afraid to shift to a lower gear, or try to avoid shifting by merely "slipping" (partly disengaging) the clutch.

**Do not use clutch pedal as a foot-rest while driving your car.**

### **Apply the brakes gently**

The brakes respond to even the slightest foot pressure. Increasing pressure will slow the car down progressively. However, avoid locking the wheels. Locked wheels will not shorten the braking distance but may cause you to lose control over the movement of the vehicle and will affect the tires adversely.

Here are a few rules on correct braking:

### **Use your brakes before, not while making a turn**

It is neither good practice nor is it economical to shift to a lower gear far ahead of a turn. Do not hesitate to use the brakes and to shift only shortly before entering the curve so that you can accelerate again while still negotiating it.

To jam on the brakes suddenly can only be justified when danger is ahead. Nevertheless, it is necessary to check full braking capacity at certain intervals so that you will be familiar with the behaviour of the car and

with the actual braking distance should sudden braking become necessary. Before carrying out the test, look into the rear view mirror to make sure that you will not endanger any vehicle that might be following you.

Operate the brakes especially gently when the road is wet or covered with ice as locked wheels will cause the car to skid.

**When driving downhill**, make use of the braking capacity of the engine compression by shifting to that gear which you would use in driving uphill.

You will save and preserve the brakes if you use them only to control the speed occasionally, and at the same time you will attain a higher degree of safety. The ignition must never be switched off when going downhill.

### Stopping the Car

Take your foot off the accelerator pedal and apply the brakes gently. Shortly before the car comes to a standstill, depress the clutch pedal, place the gear lever in neutral position and release clutch pedal again. If you wish to stop the engine, just turn the ignition key to the left.

On vehicles with the steering-ignition lock it is important to remember not to withdraw the ignition key until the vehicle is stationary as the steering is locked when the key is in the „Halt“ position.

### The Front Seats

can be adjusted to suit individual requirements. Merely raise the adjusting lever and slide the seat either backward or forward to the most convenient position. The seat rises as it moves forward, enabling short persons to sit higher.



1 — normal    2 — backward    3 — forward

The rake of the front seat backs can be set at three positions by turning a lever.



### **Safety Belts**

can be obtained from every VW Dealer. The belts for the driver and front passenger are attached to the lock pillar and the frame tunnel. You will find the mounting points for the rear seat passenger belts in the rear luggage compartment and behind the back rest.

### **Sitting Comfortably**

Sitting and driving for long periods places a certain amount of strain on the human body. It is therefore important to adjust the seat correctly to your individual requirements, and so avoid unnecessary fatigue.

Make use of the whole of the seat area by sitting well up against the back rest, thus giving yourself a maximum area of support for the legs.

Firstly adjust the rake of the seat back to the normal position. Aim at an easy, relaxed position. The whole of the back should be evenly and comfortably supported. The head should be held erect to avoid neck strain. Then slide your seat horizontally to the position where pedals, gear shift and brake lever can most conveniently be reached.

But even in the correct posture, without moving, long hours at the wheel can prove tiring, and you will soon find out how useful it is to change position from time to time.

For instance, try shifting the weight of your body away from the center, to the left or right. Change the position of your legs and feet and alter your grip on the steering wheel. The rake of the seat back can be adjusted forwards or backwards according to visibility and traffic conditions. Always make sure, however, that your back is properly and comfortably supported.

It is also a mistake to bend too far forward at the hips, with your spine away from the seat back. This causes back-ache and cramps the waist and the legs.

Often too, the driver tends to slide too far forward in his seat with the result that the lower part of the back is unsupported, and the spine bent at an unnatural angle. In this position the normal motion of the car will soon become tiring, for the further forward you slide in your seat, the more awkward your posture becomes and the less support will there be for your legs.

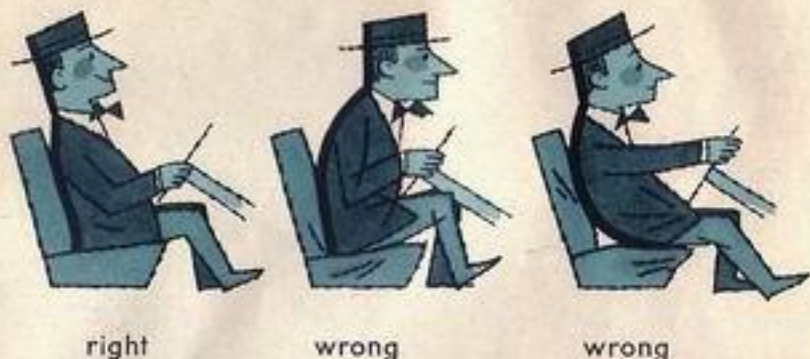

If you lean back too far, the head has to be held at an unnatural angle and the arms stretched awkwardly forward. This results in strain and fatigue in neck and shoulder muscles.



#### **Both Hands**

should be kept on the steering wheel, in an easy, natural position affording maximum control – as shown here, for instance.

### The Interior Light

is automatically operated by opening or closing either of the doors.

As an added convenience, the lamp may be operated by the manually operated three-position switch incorporated in the lamp fitting.

Positions of switch knob:

- Lower - On
- Intermediate - Off
- Upper - Door contacts

This allows the light to be turned off with the doors open.

The Convertible is equipped with a three-position tumbler switch below the instrument panel:

- Rear - On
- Intermediate - Off
- Forward - Door contacts

### The Ash Tray

below the instrument panel can be completely pulled out for emptying by slightly depressing the retaining spring.

The rear ash tray is removed by pressing it down slightly. To reinstall, press it into the housing evenly at top and bottom.

### The Windshield Wipers

operate when the knob on the right of the instrument panel is pulled out. The wipers return to the parked position automatically when switched off. The windshield washer is controlled by the small button in the center of the wiper switch. The washer is air pressure operated so that by pressing the button you can spray water onto the windshield continuously until it is clean.



Do not forget to refill the container from time to time. It is located under the front hood, behind the spare wheel, and holds about 1 liter. As the air pressure in the container escapes when the cap is removed, it is advisable to refill the container at a filling station. The container can be filled until it overflows. The pipe in the container neck ensures that there is always sufficient air to operate the washer.

The correct air pressure is 2.5 kg/sq. cm (35 lbs./sq. in.). The addition of 25% pure spirit (3 parts water, 1 part spirit) to the water in winter will protect it from freezing down to a temperature of  $-12^{\circ}\text{C}$  ( $10^{\circ}\text{F}$ ).

The wiper blades should be removed occasionally and thoroughly cleaned with a hard brush and methylated spirits or a strong detergent solution. Particularly during long dry periods they tend to become clogged with tar splashes and insects. The blades should be replaced once a year.



### **The Luggage Compartment**

under the front hood is secure against theft when the vehicle is locked. The control knob for the hood is under the instrument panel on the left.

On the Convertible the control knob is fitted with a lock. The key - which also locks the doors and the glove compartment on the Convertible - should be turned to the left and withdrawn immediately after the knob has been pulled. The spare wheel, fuel and luggage are then safe when the vehicle is left open.

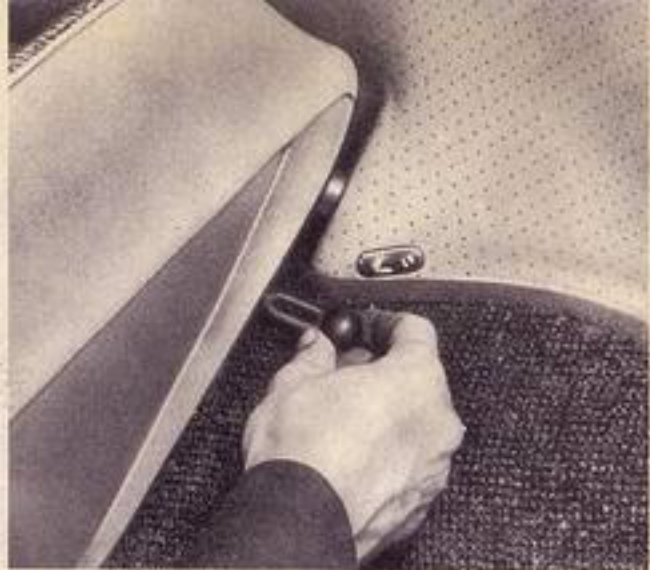

More luggage can be stowed behind the rear seat back rest. The back rest can be folded forward to facilitate stowage. In the normal position the back rest is held by a rubber loop.



### **The Sun Roof**

is operated with a crank. The crank handle is flush mounted in a recess between the sun vizors.

After folding the handle out, the roof can be opened to any desired position and is fixed automatically.

To close the roof, crank it forward as far as it will go, then turn the handle back slightly and fold it into the recess.

## Misted Windows

can greatly obstruct visibility on all sides. This is brought about by the humidity from the passengers' breath in the car and a low outside temperature. By using the vent windows intelligently sufficient fresh air can be provided while the used air is sucked out. Not only will the windows remain clear but so will your head.



## The Convertible Top

can easily be lowered and raised by one person. The service life of the top largely depends on the way the top is lowered and raised. That is why we would particularly stress the importance of the following recommendations.

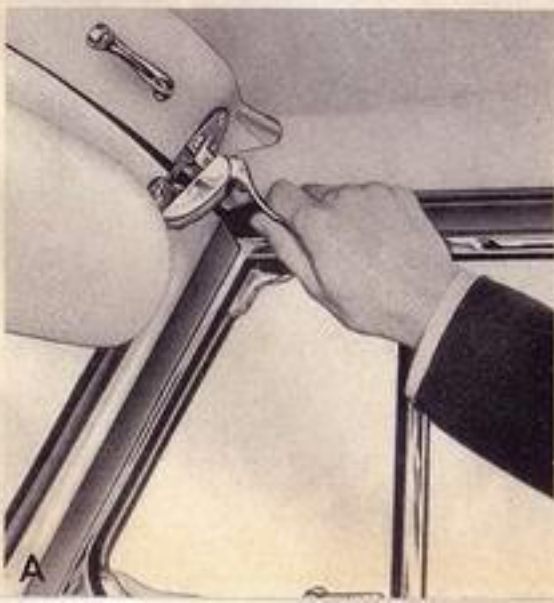

### To Lower the Top

- 1 - Pull the two clamps above the windshield downward to unfasten the top (A).
- 2 - Raise the headers slightly and fold back the top.



- 3 - Withdraw top cover from the linkages on both sides (B).

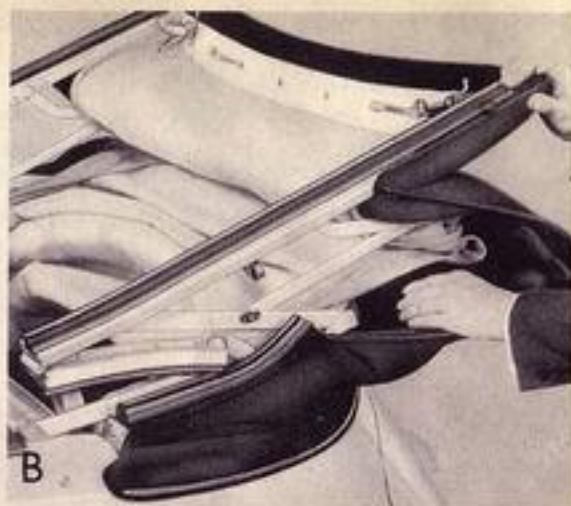

- 4 - Push the top lining inward so that the linkages are free (C).

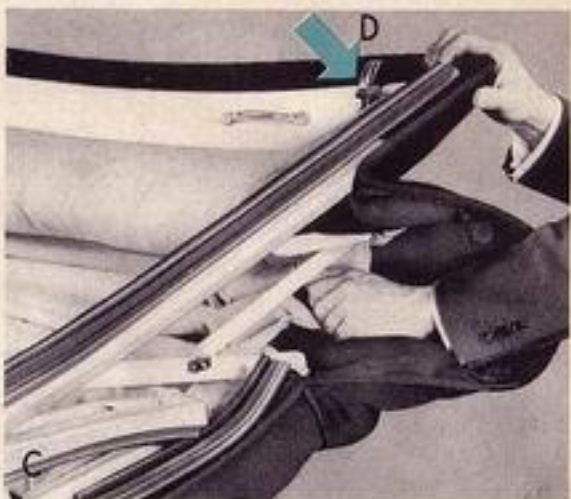

- 5 - Place the caps of the top clamps over the header guides and press down the levers (D).

- 6 - Press down the top until the spring-loaded catches (one on each side) engage in the slots cut in the side rails (E).



- 7 - Taking particular care with the lower part, install the protective boot and secure it with the snap fasteners over the folded top cover which should be completely concealed except for the ornamental edge which remains visible.

## To Raise the Top

- 1 – Unsnap the fasteners of the protective boot and remove. It can then be stored in one of the two luggage compartments.
- 2 – Raise the clamp levers.
- 3 – Press down the top and disengage the catches.
- 4 – Raise the top.
- 5 – Pull the top down until the header guides have entered the channels above the windshield frame.
- 6 – Place the clamp caps over the noses of the brackets and turn up the levers.





## PRACTICAL DRIVING

### Breaking-in Instructions

are not necessary for the Volkswagen. The most modern production and inspection methods have made it possible to dispense with the initial speed restrictions which are normally required. You can drive the vehicle at full speed from the first day.

It is advisable, however, to observe certain fundamental driving rules at all times. You can influence the performance and service life of your vehicle considerably by doing this.

Always keep the vehicle speed within the permissible ranges for the various gears.

#### 1st gear

0-15 mph

0-25 kph



### You can drive very economically between:

So do not rev the engine too high in neutral nor when driving in the individual gears.

On the other hand, do not labor the engine by driving too slowly in the gears.

Always change down in good time on gradients and keep the engine at the most favorable rpm.

## Economical operation

is one of the outstanding features of your car. However, getting a few extra miles from each gallon depends on the manner in which you handle the car and use the gears.

### When accelerating,

press the accelerator pedal slowly and only to such an extent as is necessary to reach the desired speed. Depressing the accelerator pedal rapidly does not improve acceleration, but results in an increased fuel consumption.

### Do not "pump" the accelerator pedal

unless circumstances require it. Even the small quantity of fuel additionally discharged by the accelerator pump each time the accelerator pedal is depressed results in a marked increase in the overall fuel consumption.

#### 2nd gear

6-30 mph  
10-50 kph



6 and 22 mph  
10 and 35 kph

#### 3rd gear

15-45 mph  
25-75 kph



15 and 35 mph  
25 and 55 kph

#### 4th gear

25-72 mph  
40-115 kph



25 and 56 mph  
40 and 90 kph

## Drive your car smoothly and to suit the circumstances

both when in city traffic and on main roads. Adapt the speed of the car to prevailing road and traffic conditions. A good driver accelerates gradually, slows down in time, and utilizes the braking power of the engine. Make use of the full acceleration capacity and the excellent brakes of your car only when you really need to.

## How to drive at high speed without sacrificing fuel economy

When you have accelerated to the desired speed, slowly let the accelerator pedal return to the position which just maintains this speed. This practice is especially economical when driving on highways. If you attach particular importance to economy and also to a fair average speed, you will be well advised to select a suitable cruising speed in the most efficient range of

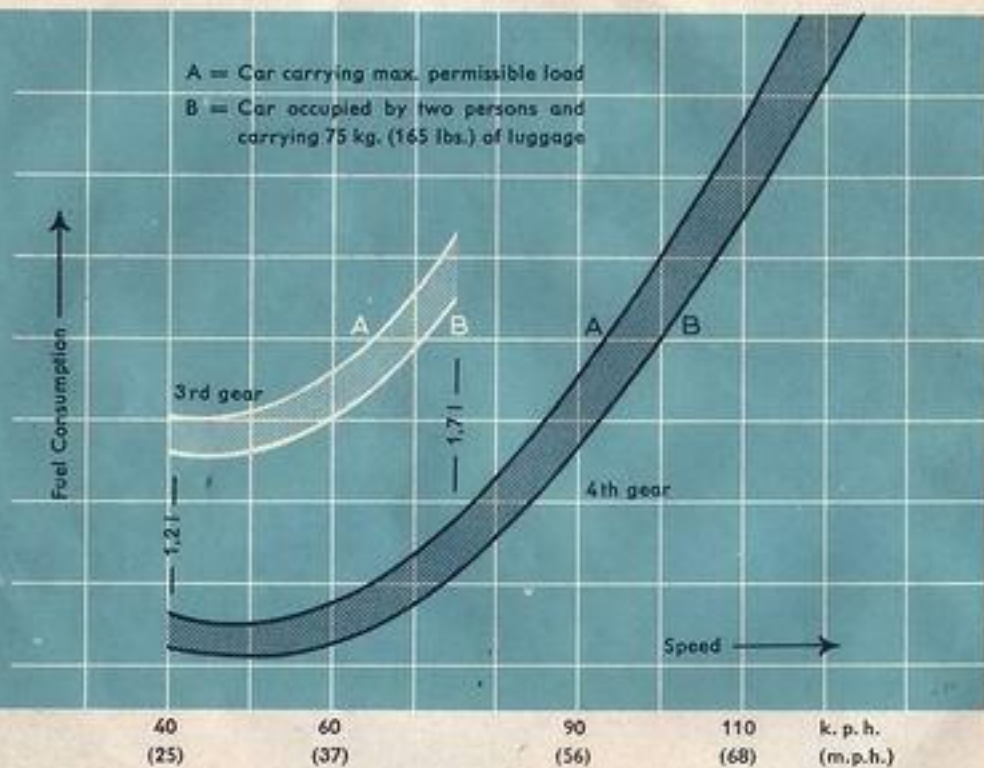

consumption. The graph illustrates the relationship between fuel consumption and speed; it increases more rapidly at higher speeds.

Perhaps you are aware of the fact that air resistance is an obstacle for all vehicles especially at high speeds. Due to the simple and sweeping lines of your Volkswagen, air resistance is relatively low, but remember that high road speeds always involves a greater fuel consumption.

You can also see from the graph that the fuel consumption will increase if you shift down too soon and, for example, drive for a period in town traffic in 3rd instead of 4th gear.

## Watch the Road

closely while driving. You should now be able to operate the various levers, switches and controls automatically. Furthermore, your Volkswagen will "tell" you on its own accord when it needs attention.

### Headlights

The high beam of your headlights can be blinding to oncoming drivers. You know yourself how unpleasant and dangerous this is. For this reason, be considerate. The blue light will tell you when the high beam is switched on. Just step on the dimmer switch to transfer the headlights from high to low beam.

### Generator and Cooling

are controlled simultaneously by a red light. The light will show when the ignition is turned on and when the engine is running at low speed. The light should go out when speed is increased.

**Important.** If the red light comes on while you are driving the car, the fan belt may be broken. Bring your car to a stop, and find out what is wrong, for if the belt is broken, the cooling is disrupted and the generator no longer charges.

### Oil Pressure

The oil pressure of your car is as important as the oil level, which you have already checked. When the ignition is turned on, the green oil pressure light will go on. The light should go out when the engine is started and the oil pressure increases.

**Important.** If the green light comes on with the engine running, the chances are that the oil circulation has been interrupted, which means that the lubrication of the engine has ceased. Stop at once and check the level of the oil before you consult a Service Station. An occasional flashing of the lamp with the engine warm and at low speed does not indicate trouble, if the light goes off again as the speed increases.

### Flashing Indicators

The direction indicators lie outside the driver's vision. However, the green light will show you when the indicators are in operation. The direction indicator switch which is self-cancelling can be operated without taking the hand off the steering wheel.

### Blue Light

### Red Light

### Green Light

### Green Arrows



## **Safety First**

Safety for yourself, and safety for others, this is what counts most. Your Volkswagen is a car that "hugs" the road in an excellent way, and does not roll when taking a turn. Your car has good acceleration but the feeling of security and safety which you will acquire after a few miles should not tempt you to become careless.

Therefore, adjust the speed of your car to the conditions of road, traffic and weather, and always be ready to bring your car to a stop when it is necessary. Be particularly careful when driving on wet or icy roads, for even a Volkswagen is apt to skid when not driven carefully under such conditions.

## **Rear View Mirrors**

can be adjusted to suit individual requirements.

Adjust the outer mirror so that you can see rearward alongside the car without having to turn your head or shoulders. You will then get a clear view of the road behind you.

The inner mirror of the Convertible is adjustable to ensure a perfect view, no matter if the top is lowered or raised.

## **Passing Other Cars**

Pass other vehicles with consideration. Always be sure that the road is clear ahead of you, and look out for cars approaching you from the opposite direction. A brief look in your rear view mirror will tell you whether another car is about to pass you from behind. And here is another warning: Never try to pass a car when approaching a curve, where vision is not clear, and never pass a vehicle at the crest of a hill, or at crossroads. You never can tell what lies ahead of you.

Be fair and do not step on the accelerator pedal when another car tries to pass you. You will endanger your life and others.

## **Stopping Your Car Temporarily**

**When stopped at an obstruction, a traffic light or railroad crossing, do not wait with the clutch pedal pressed down and the gear lever in position. Shift to first gear shortly before moving on again, it will preserve the clutch.**

## Parking your Car

in a space between two other cars that are parked at the curb can be easier if you heed the following advice:

Stop your car level with the car in front of the space. Turn the steering wheel sharply to the right and back your car slowly into the gap.



When the front bumper of your car is level with the rear bumper of the car ahead of you, turn the steering wheel fully to the left, and back up further toward the curb.



Now turn the steering wheel to the right again and pull up a little bit, until both ends of the car are as close to the curb as possible.



When parking on a steep slope, set the handbrake to stop the car rolling. As a precautionary measure, it is advisable to engage first or reverse gear in addition to the handbrake. And do not forget to take the key out of the ignition switch before you leave your car.

If a steering-ignition lock is fitted, remove the key at the "Halt" position. This locks the steering and protects the vehicle against theft.

Prior to locking the driver's door, secure the door on the other side by pushing the inside door handle forward. The vent wing handle is locked by turning it until the push button is heard to spring out.



## COLD WEATHER HINTS

### In Winter

you will greatly appreciate the air cooling and the heating of your car. You may leave your car out in the bitter cold without fear. The air-cooled engine will always start readily and will heat up the interior of the car quickly and uniformly.

### The Warm Air Heating

of your car can be regulated by a rotary knob situated adjacent to the gear lever:

Anti-clockwise - On (1)

Clockwise - Off (2)



1 - on      2 - off



1 - open      2 - closed

The distribution of the warm air can be varied to suit the wishes of the occupants by means of slides on the outlets at foot level in the front and by flaps on the openings in the rear foot well. Furthermore, the flow of warm air to the windshield defrosters can be increased by restricting the air flow at foot level.

The car will warm up quicker if you open a vent window so that the blower can force the warm air more easily into the otherwise well sealed interior.

Never attempt to influence the cooling and thereby the heating of your car in winter by covering the air intake slots below the rear window. The cooling air slots must always be clear in order to avoid interference with the air supply to the carburetor and cooling fan.

## Engine Oil

SAE 20 W/20 oil will not thicken at temperatures down to 0° C (32° F) and will permit easy starting of the engine. If, however, temperatures below freezing point are anticipated the use of SAE 10 W is recommended.

This grade of oil may remain in the engine with safety when the temperature again rises to a higher range. Should it become necessary to add oil in the period between two regular oil changes, SAE 10 W oil may be used during lasting frost and SAE 20 oil when the average temperature rises. This means that the SAE 10 W and SAE 20 W/20 grades can be mixed without detriment, but be sure to use always the same brand and type of engine oil.

The engine does not need to be warmed up before moving off, but it is advisable not to race the engine immediately after starting when the temperature is low.

Only if your car is mainly operated over short distances **during cold weather** is it advisable to have the oil changed at more frequent intervals, say every 2,500 km. (1,500 miles), using the right HD oil. In the warmer seasons, oil changes extra to those laid down in the Lubrication Chart are unnecessary and uneconomical.

In territories where **exceptionally low temperatures** prevail (below -25° C / -13° F), the use of SAE 5 W is recommended: this should be changed every 1,250 km. (750 miles). The oil strainer should be cleaned at the same time.

## Transmission Oil

The SAE 90 oil can generally be used all the year round. It need only be replaced by the thinner SAE 80 grade in countries with arctic climates.

## The Chassis

is particularly exposed to moisture in winter. You are therefore strongly advised to adhere strictly to our instructions for lubrication. If, in addition, you spray the underside of the car with a suitable anti-corrosion solution, as a protection against rusting, you will prolong the life of your car, and reduce ice formation on the chassis when the road is wet and the temperature low.

## The Brakes

of all automobiles are more or less exposed to splashing water which in winter is apt to freeze in the brake drums. Therefore, when parking your car, do not set the hand brake, but engage first or reverse gear.

### **The Door Lock**

can freeze up in the winter, especially if water gets into the lock cylinder when washing the vehicle. You should, therefore, not aim the water jet directly at the lock, or better still, cover the key hole up when washing. A frozen lock can be opened by warming the key before insertion and then squirting anti-freeze into the lock cylinder straight away.

### **Tires**

Worn tires are apt to cause trouble in winter. For safety's sake replace them in time. To meet the special requirements in winter, so-called M+S tires are available. These special-tread tires are designed to give a better grip in mud and snow. They are either used on the rear wheels only or on all four wheels. However, during the rest of the year you should use the normal tires.

### **Chains**

You will need chains only when the roads are covered with snow or ice. Without such chains, the rear wheels of your car are apt to spin, and applying the brakes may result in the car skidding. Have the chains adjusted to the wheels if you wish to avoid loss of time and inconvenience later on.

When driving on long stretches which are free from snow, the chains should be removed to avoid unnecessary wear of both chains and tires.

### **The Battery**

is under greater strain in winter than in warmer seasons because of the increased consumption of current when starting the engine and using the lights at night. Besides this, it is a characteristic feature of any battery that its efficiency decreases at low temperatures. If the car is mostly used over short distances, the battery may require additional recharging.

Therefore, have your battery checked regularly, and you will never encounter any starting difficulties.

### **Spark Plugs**

The normal spark plug gap is 0.7 mm. (.028").

In extremely cold weather reduction of the gaps to 0.4-0.5 mm. (.016"-.020") will aid cold starting considerably.

## **Proper Lubrication is of Vital Importance to Your Volkswagen**

The extra time spent in following these recommendations will be amply rewarded in the long run by your car's efficient performance. It is up to you to maintain the standard of safety offered by your Volkswagen, and to ensure the long life and good service which you have the right to expect from this truly economical car.



### **To lubricate correctly means to lubricate carefully and at prescribed intervals.**

Therefore, do not shy at the work connected with the regular lubrication service. A Lubrication Chart can be found on page 83, indicating the correct mileages at which to lubricate.

The Service Booklet makes it possible for you to have your Volkswagen lubricated at our authorized workshops by skilled personnel, with the best available lubricants, at lowest cost and in a minimum of time. You really cannot afford to miss this opportunity.

### **Engine Oil Change**

Regular oil changes are necessary even if the very best branded oils are used. Dirty oil in your engine simply means increased wear and a shorter life for your engine. On the other hand, provided that HD oil is used, it is unnecessary and uneconomical to change the oil more frequently than called for in the Lubrication Chart.

The oil is drained, when warm, by removing the plug in the oil strainer bottom plate. Flushing of the engine is unnecessary. However, the oil

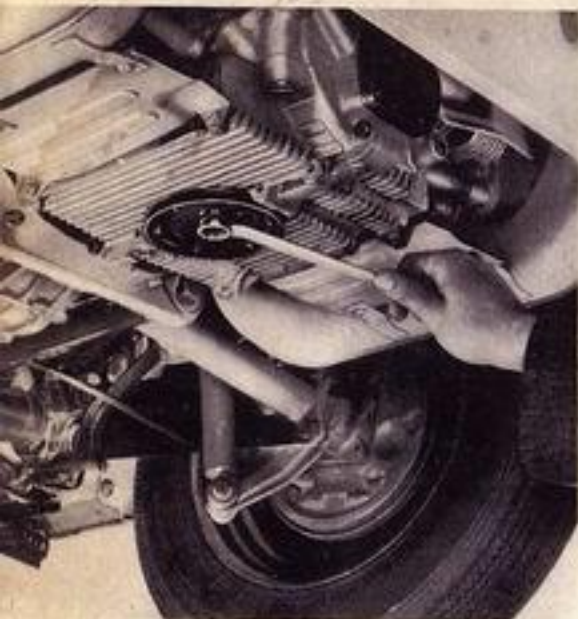

strainer must be removed and cleaned at every oil change. The two gaskets must be renewed each time. The engine is refilled with 2.5 liters of HD oil (5.3 US pints / 4.4 Imp. pints).

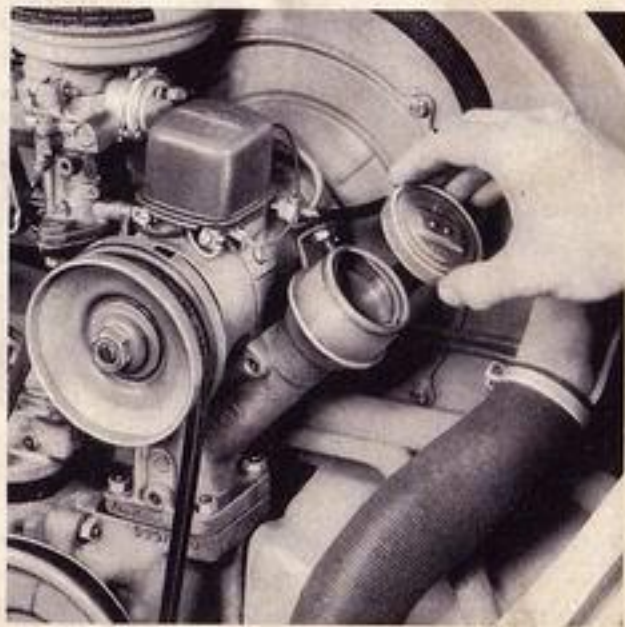

## Types of Lubricant

There are good reasons for using a  
**branded HD oil**  
in your VW engine.

HD oil is an oil with proved oxidation stability, bearing corrosion preventive properties and detergent-dispersant characteristics which tend to hold in suspension foreign contaminants which would normally deposit on engine parts. These foreign contaminants drain out with the oil at the periodical oil changes. The detergent properties of HD oil make the fresh oil darker after a short time of operation. This is quite natural and there is no reason whatsoever to change the oil earlier than called for in the Lubricant Chart.

## Some more Information on Oils

It is left to your discretion to select an oil from well-known and dependable brands of the proper viscosity to suit your seasonal and driving requirements. In cases of doubt, refer to your authorized VW Dealer who will be glad to help you with your lubrication problems. It is recommended that you select "your" oil after the first 500 km. (300 miles) and stick to it at all future service oil changes. Viscosity of the lubricant is an indication of its resistance to flow at a given temperature. The SAE numbers classify lubricants in terms of viscosity, but with no reference to other characteristics or properties.

**SAE 30** engine oil is satisfactory in tropical climates where the temperature will frequently rise above 30° C (86° F).

**SAE 20 W / 20** engine oil is suitable for temperatures between 30° C and 0° C (86° F and 32° F).

**SAE 10 W** engine oil should be used in the winter if it is anticipated that the temperature will drop below freezing point before the next oil change.

**SAE 5 W** This extremely light engine oil is for use in arctic climates below -25° C (-13° F) only.

For further details of oils for winter use, see page 33.

In some countries the API Classification is applied (API = American Petroleum Institute). According to this classification, the HD oils suitable for the VW engine are referred to as "For Service MS".

### **Multigrade Oils**

are HD oils which cover several viscosity grades, such as SAE 10 W-30 for example. These oils are also suitable for VW engines.

**No additives** of any kind should be mixed with HD oils.

### **Transmission**

The transmission and differential gears are combined in the transmission case and both lubricated with the same hypoid oil. Timely oil changes have a beneficial affect on the smooth running of the gear trains. The old oil is drained by removing both the magnetic drain plugs while the oil is at operating temperature. The drain plugs must be cleaned thoroughly.

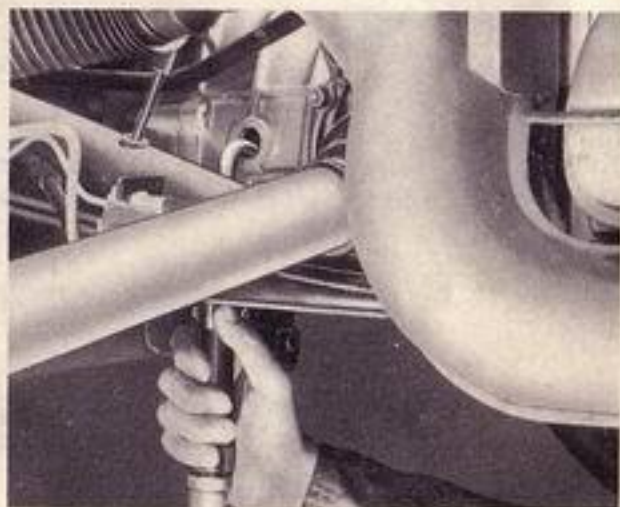

Then refill with 2.5 liters (5.3 U.S. pints, 4.4 Imp. pints) of hypoid oil.

**No additives** should be used with hypoid oil.

### Steering Gear

The steering assembly should be lubricated exclusively with SAE 90 Hypoid gear oil and under no circumstances with grease or other oils. It is accessible through an opening behind the spare wheel. The level of the oil in the steering case should be kept slightly below the filler plug hole.



### Chassis

The front axle bearing points can only be lubricated properly when the axle is free of load, that is, with the vehicle lifted. There are eight points on the front axle which must be lubricated every 2500 km. (1500 miles). If the vehicle is frequently driven on bad roads it is advisable to grease the king pins again approximately every 1250 km. (750 miles).

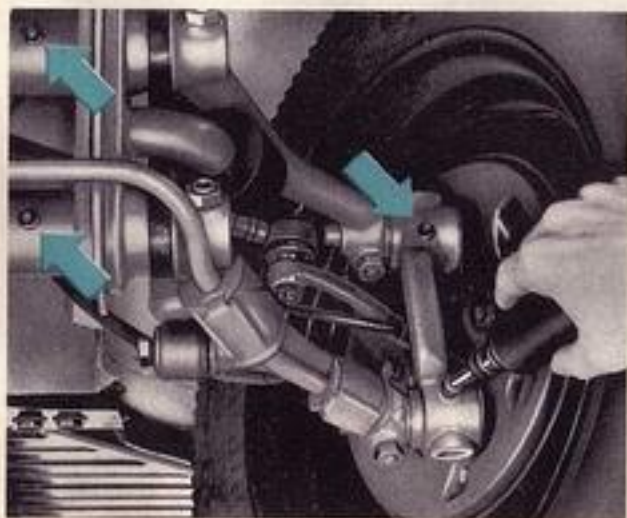

Before greasing, the nipples should be wiped clean with a rag to prevent dirt from getting into the bearings. Grease must not be allowed to get on to tires and brake hoses. Even small quantities should be wiped off immediately.



Please check the dust seals on the maintenance-free tie rod ends for damage and security at every lubrication service. Damaged dust seals should be replaced as soon as possible.

Every year, preferably at the beginning of the cold season, the clutch, accelerator and heating control cables and the clutch cable adjusting nut should be checked and cleaned and greased if necessary.

### **The Front Wheel Bearings**

are packed with sufficient grease at the factory. The caps on the front wheel hubs must be free from grease.

According to the maintenance chart the front wheel bearings should be cleaned and repacked with the grease specified under the heading "Lubricants" every 50,000 km. (30,000 miles). The brake drums must be removed for this purpose. Finally the front wheel bearings must be adjusted. In order to avoid damage to the bearings, this operation should, if possible, be carried out in a VW Workshop.

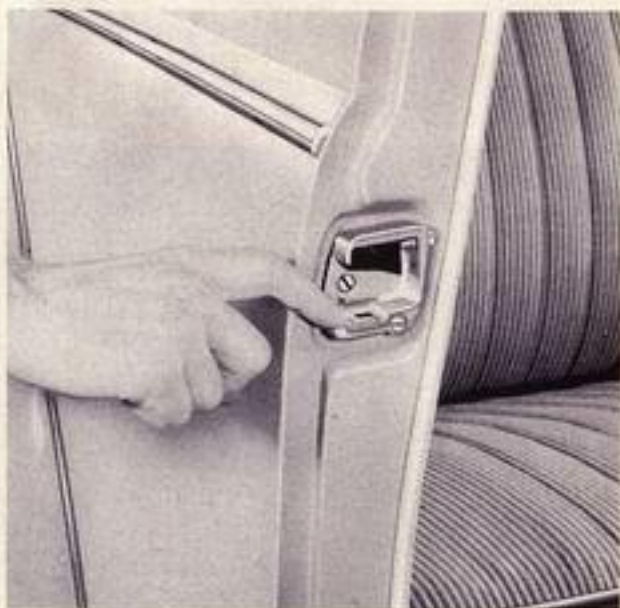

### **Doors**

The door lock striker plates should be very lightly greased. Apply a few drops of oil to the hood hinges. The door hinges should be oiled at every lubrication service or, better still, once a week after dust and dirt has been removed.



To oil the door lock, apply a few drops of oil to the hole situated above it.

Door lock cylinders should be treated with graphite only. Dip the key into the graphite powder, insert key in lock and move it back and forth several times.



### Front Seats

The upper and lower sliding surfaces of the seat runners should be greased. A small amount of grease will suffice to provide easy movement of the seats. Prior to lubrication, wipe over the runners with a rag. To remove the seat, slide it fully towards the front. When installing the seat, hook the spring in position.

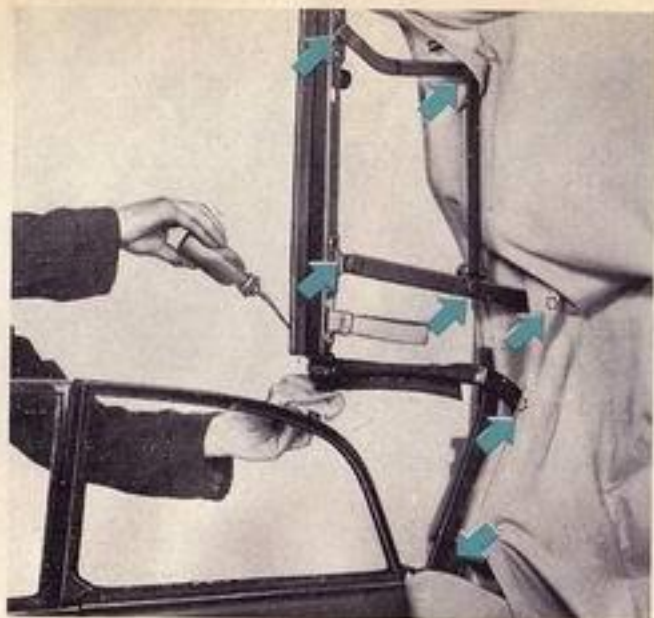

### **Convertible Top**

Whenever necessary, the joints of the top linkages are lubricated by applying a few drops of oil after removing dust and dirt. Care should be taken to avoid oil getting on to the top cover, as oil has a detrimental affect on the rubber sealing layer.

## WHEELS AND TIRES

Under-inflation or over-inflation are the most common causes for tire failures. High speed driving and cornering, skidding to a stop and striking curbs or objects on the road wears tires more than many miles of careful driving.

Avoid overloading the car and protect the tires from intense sunlight, fuel, or oil.

From time to time the tires should be checked for embedded foreign matter and external damage. The tires should always be replaced when the tread has worn down to a depth of 1 mm. (.040") as beyond this limit the tires are unsafe. If you notice that the tires are wearing unevenly after a considerable mileage, consult your VW Service Station.

For smooth running at high speeds and long tire life, it is important to have the wheels balanced statically and dynamically when tires have been removed. As the wheels can be out of balance after being in use for a long time, owing to natural tire wear they should be balanced statically and dynamically every 10,000 km. (6,000 miles).

When the tires are being mounted, the red mark on the sidewall should be lined up with the valve to ensure better balancing of wheel and tire.

### Changing wheels

Changing a tire on the road in the rain is certainly not pleasant. However, it will be easier after you have read these few lines which tell you the correct way. Underneath the front hood, you will find the spare wheel, jack and tool kit.

- 1 - Set the hand brake securely and block the wheel opposite the one being removed to prevent the car shifting off the jack.
- 2 - Insert the jack into the square tube below the body sill panel in front of the rear fender and push down the jack base plate until it makes contact with the ground.
- 3 - Remove wheel cap with the removal tool.

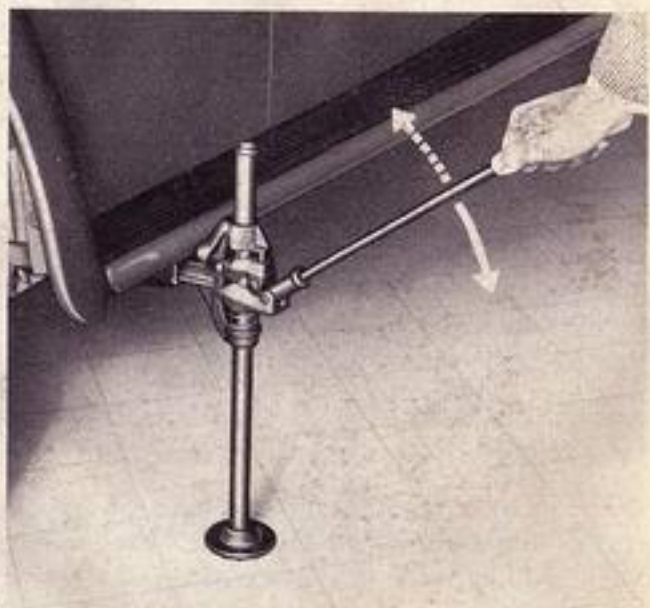

- 4 - Loosen wheel bolts with the socket wrench before wheel is fully jacked up.
- 5 - Raise vehicle until tire clears ground.

- 6 - Remove wheel bolts and take off the wheel.
- 7 - To install the spare wheel, operate the jack until the five holes in the wheel are nearly lined up with the holes in the brake drum.
- 8 - First, insert one wheel bolt only. Tighten it to such a degree as to allow the wheel to be swung around this point by hand until the remaining holes in the wheel and brake drum coincide.
- 9 - Insert the remaining bolts until the countersunk heads are centered in the corresponding recesses of the disc-wheel.
- 10 - Tighten all bolts diametrically opposite in turn.
- 11 - Insert the jack operating bar into the hole marked "ab". Lower the car by pressing down the operating bar. After lowering the car do not remove the operating bar at once, but first of all pull up the base plate. Now remove the jack.



- 12 - Make sure that all bolts are tight.
- 13 - Install wheel cap and make sure that it is tightly seated.



## CARE OF THE CAR

### Clean and Smart Appearance

To keep the Volkswagen looking smart and new should be a matter of pride to the driver or owner of the car. It is our object to provide you with paintwork which not only looks good and has a sparkling lustre but is most durable. A chemical treatment protects the body against rust and corrosion and anchors the paint securely to the metal. The finish is of high-quality synthetic resin enamel and carefully blended to obtain the most beautiful shades.

You will realize the importance of the paint finish if you consider that it is exposed to the elements; it has to resist sunshine, rain, dust and dirt. That is why periodic care of the body is necessary to retard any disintegrating process.

## **Washing Your Car**

Wash your new car frequently during the first weeks as this is good for the finish. When washing you require a soft sponge for the body, a soft brush for the wheels, a sturdy, long-handled brush for the chassis, and plenty of clean water. For drying the car you need a chamois.

The chassis and lower part of the body should first be flushed with water, to soak off the dirt, and afterwards a brush should be used.

Spray the exterior finish of body and wheels evenly with water until dirt is soaked off. Do not allow a powerful jet of water to hit the painted surface. Using plenty of clear water, remove dirt with a sponge. Care should be taken to clean the sponge at short intervals to avoid scratching the paint.

There are some approved auto soaps and detergents which greatly facilitate this job. Avoid the use of any product which has not been recommended by your VW Dealer. It is of utmost importance to rinse the body thoroughly with water after the car-wash has been applied to ensure that no traces of it remain on the body.

After washing, rub down with a clean chamois to prevent water spots.

## **Preservation (Waxing)**

means to restore to the finish certain substances it has lost by exposure to the weather. As these substances are vitally important to the elasticity of the finish, it is necessary to apply a protective water-repellent coat of wax to the body. The intensive cleaning affect of the shampoo removes this protective coating so that it should be renewed accordingly. A preservative specially produced for the finish of your Volkswagen can be obtained under the designation "L 190" from your VW Dealer. The body should be waxed after the first eight or ten weeks and then regularly at intervals of from six to eight weeks - in any case after each soap or detergent washing, as already mentioned. Applying the preservative is quite easy: With a soft cloth, spread a thin film on the finish, then rub it down when dry (after about 20 minutes), using polishing cotton or a soft polishing cloth, until iridescent colors can no longer be seen when you are standing at an angle to the polished area.

Of course, the car must be washed and dried carefully prior to applying the preservative.



## **Polishing**

You should polish your car only if its appearance has been strongly affected by road dust, sunlight and rain as a consequence of insufficient care, or if the application of the preservative no longer restores the original lustre. Avoid the use of abrasives or chemically harmful products, even if their first application seems to give satisfactory results. A special polish for the synthetic-resin enamel finish is also obtainable from your Volkswagen Dealer under the designation "L 170".

Prior to applying the polish, the car must be washed and dried carefully. Dust or dirt should never be wiped off dry. The polish should be applied with a soft clean cloth or polishing cotton – use a straight horizontal or vertical motion rather than a circular motion. After rubbing for some time you will feel a slight resistance, which indicates that the ingredients of the polish have settled in the finish and that the solvent has evaporated. Now take clean polishing cotton and rub the body down until the high polish is restored. Do not apply the polish on too large an area of the body at a time.

A subsequent application of the preservative and your efforts will be rewarded with a long-lasting shine.

**Never wash, wax or polish the car in sunlight or when the metal is warm.**

## **How to Remove Spots**

Water alone will not always remove splashes of tar, oil traces, "baked on" insects, etc. On principle, such foreign matter should be removed as soon as possible otherwise permanent damage may result to the finish.

## **Tar Spots**

An unpleasant sight, to be noticed particularly on light-colored cars, are tiny tar spots which show up on the fenders on hot days when driving on newly tarred roads. Tar splashes have a tendency to corrode the finish within a short time and should be removed as soon as possible. On the road, you usually have nothing at your disposal but fuel, which may be

applied with a soft cloth. Kerosene or turpentine oil may also be used. After this, the treated spots should be washed with a mild, lukewarm detergent solution, and rinsed, in order to remove traces of the cleansing agent. It is, however, better to use our preservative already mentioned, which renders the treatment with detergent solution unnecessary.

### **Insects**

are caught especially during the night, in hot weather, by fenders, headlights, and front hood. Once baked on they are very difficult to remove with water and sponge, and should be treated with a lukewarm detergent solution.

### **Parking under Trees**

Cars which are parked under trees for long periods in the summer become covered with spots. These stains, too, can be readily removed with detergent solution.

After-treatment of the cleaned spots with the preservative is strongly recommended.

### **Care of the Convertible Top**

The appearance and life of the top greatly depend on proper care and maintenance.

The top must always be perfectly dry before lowering it. After driving on dusty roads, lightly beat out the top and brush the fabric in line with the pile as any sharp foreign particles will harm the top fabric if not removed quickly.

Friction damage can also occur if the catches do not hold the roof tightly when it is open. When this happens, consult your VW Service Station.

Never use benzine, benzole, spot remover or other solvent solutions to remove spots as these fluids will attack the rubber layer in the roof and influence the water-proofing and service life of the material. Try rubbing

the spot carefully with an eraser followed by brushing with a soft brush. This will avoid premature bleaching caused by washing too often with soap solutions.

Only when very dirty, and not more than twice a year, should the top be washed. Use only clear water without chemical or other additions, and a good quality soap powder. The car shampoos which are often used nowadays also have a detrimental affect on the impregnation of the top material and can cause leakage even after one application.

Before washing the top should be lightly beaten and brushed. Dissolve the soap compound in a bucket of lukewarm water (2 dessert spoonfuls to 1 gallon of water). Moisten the top with clear water and apply the solution with a soft brush in one direction only. Then rinse the top with clear water and brush at the same time. If necessary, scrub with suds again.

The final rinsing should be continued until all traces of soap are removed and the water runs off quite clear. The soap suds should then be washed off the paintwork of the vehicle and the surface dried with a leather. The top must be left up until dry.

### **Chromium-Plated Parts**

should be treated with "Genuine VW Chrome Cleaner Chromlin" when dry. Chromlin is applied thinly and allowed to dry for 10 minutes. Then polish the parts with a dry cloth.

### **Care of the Cloth Upholstery**

If a vacuum cleaner is not available, the upholstery should be cleaned thoroughly with a brush or whisk broom. Grease and oil stains on the upholstery or interior trim cloth are removed with cleaning fluid. To avoid forming a ring do not pour the cleaning fluid directly on the spot.

Moisten a clean, uncolored cloth with the fluid and rub with a circular motion, starting outside the spot and working inwards to the center.

Other stains can generally be removed with a lukewarm detergent solution.

## Care of Leatherette Upholstery

The roof, side panels and seats should be cleaned with a soft cloth or brush. If very dirty, these parts can be cleaned with lukewarm soap powder solution or with a dry foam cleaner. When the wearing surfaces of the seats are also of leatherette, only a dry foam cleaner may be used. These surfaces are of a special leatherette material which is permeable to air so that liquid cleaners would immediately penetrate into the textile backing.

Grease or paint spots should, wherever possible, be wiped off before they dry. Soaked in spots can be removed by rubbing carefully with a cloth moistened with benzine or methylated spirits. Shoe polish marks can be removed with turpentine. Prolonged use of these agents can damage the dust-repellent protective finish of the leatherette, so be careful. Trichlorethylene or paint thinner should never be used for cleaning purposes.

After cleaning, the leatherette should be dried thoroughly with a soft cloth. So-called preservatives are not suitable for leatherette because they do not soak into the material and will merely collect dust and make clothing dirty.

## Cleaning Glass

Windows can be cleaned by washing with water and wiping dry with a clean, soft linen cloth or chamois. To facilitate this task on the windshield, the arms of the windshield wipers may be tilted forward. To clean exceptionally dirty windows, use alcohol or household ammonia and lukewarm water.

## Door and Window Weather Strips

It is important to keep the rubber parts undamaged and supple to ensure perfect sealing of doors and windows on the Convertible. A light coating of powdered talc on all rubber parts every time after the car is washed is recommended to retain the original flexibility and to reduce friction. Noises due to friction between the side windows frames and the rubber strips can easily be eliminated on the Convertible by using a mixture of glycerine and talc.

### **Airing the Interior**

If the car is left stationary for a long period in your garage, it must be aired regularly. Permit air to circulate freely through the body by opening the doors and lowering the windows to prevent the formation of mould and dampstains.

# MAINTENANCE

The VOLKSWAGEN SERVICE ORGANIZATION has made available for you an extensive network of Authorized VW Workshops staffed with well trained and experienced men, and equipped with all the special tools and appliances required to service your car. If ever you should need service when touring and away from home, look for the well-known VW Service Sign. The workshop displaying this sign is your assurance of the same expert, prompt, and courteous service you are accustomed to receive at home.

In case you can't get to an Authorized VW Workshop in time, we are giving you some information which will help you to carry out small repairs. However it is important that repair jobs which are beyond your capacity should be performed by the nearest VW Workshop. There your car will be given expert treatment by those familiar with its construction.

This will save you time, inconvenience, and money.

## Checking Air Cleaner

The oil bath air cleaner should be checked every 5000 km (3000 miles).

All the dust present in the air drawn in by the engine is retained by the filter insert in the upper part of the air cleaner and washed out when the vehicle is in motion by the oil in the lower part of the cleaner. In time, this causes a layer of sludge to form at the bottom of the lower part. If the cleaner check reveals that there is only 4-5 mm (.16-.2") of oil above the sludge layer, the lower part should be carefully cleaned and filled with fresh oil. The top part does not need cleaning.

However, if the filler insert has become so dirty due to delayed cleaning or oil shortage that the air inlet holes on the underside are partly blocked, the encrusted dirt should be removed, preferably with a small piece of wood.

A dirty filter insert not only reduces the engine output, it can also cause premature wear in the engine. If the local conditions are such that the vehicle is frequently driven over very dusty roads it is advisable to clean the air cleaner more often.

The warm air control flap should be checked each time for freedom of movement. This flap regulates the flow of pre-heated air to the carburetor in conjunction with the speed of the engine.



1 - Filter element, 2 - Gasket, 3 - Oil reservoir

### **Servicing Air Cleaner**

Pull crankcase breather hose off air cleaner.

Pull pre-heater hose off air cleaner intake elbow.

Loosen air cleaner clamp screw.

Take air cleaner off carburetor and disassemble.

Never lay the upper part down with the filter element upwards.

Clean the lower part thoroughly and fill to the mark with fresh SAE 20 engine oil.

When installing the air cleaner, ensure that the red line on the clamp is in line with the left rib on the upper part of the carburetor.

### **Adjusting and Replacing the Fan Belt**

To adjust the fan belt, remove nut and outer half of generator pulley. When loosening or tightening nut, insert a screwdriver in the slot cut

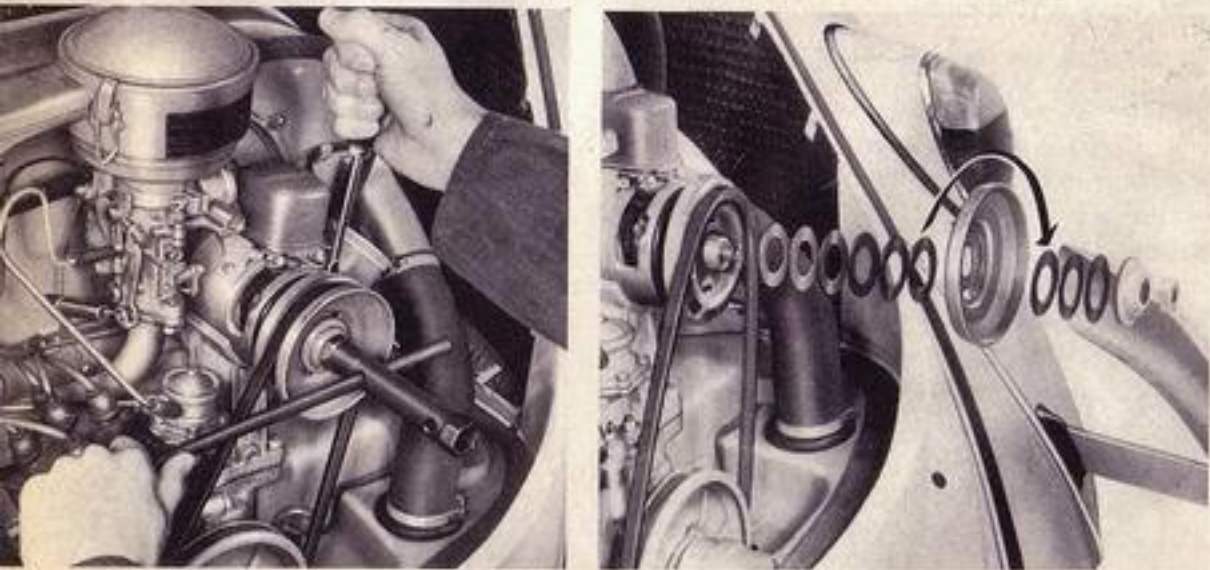

into the inner half of the pulley, and support it against upper generator housing bolt. To remove the fan belt, the cover plate for the crankshaft pulley must be removed after taking out the three securing screws. The fan belt tension is adjusted by means of spacer washers situated between the two pulley halves. Belt slackness is taken up by removing one or more washers. If the belt is too tight, one or more washers should be added.

The fan belt should not be too slack, nor should it be too tight. Newly installed belts will stretch to some extent and should, therefore, be checked and adjusted after 500 kilometers (300 miles) running. Further adjustment is not necessary as the tension will not alter any more.

Be sure you are never without a spare belt.

### **Cleaning the fuel filter**

The fuel pump filter prevents foreign matter and dirt from entering the carburetor.

The filter should be cleaned at the prescribed intervals.

- 1 - Install clip on fuel hose between frame fork and engine compartment.
- 2 - Remove retaining screw and take off cover.
- 3 - Take out filter and wash it in benzine.

When installing the filter do not forget the gasket for the cover.

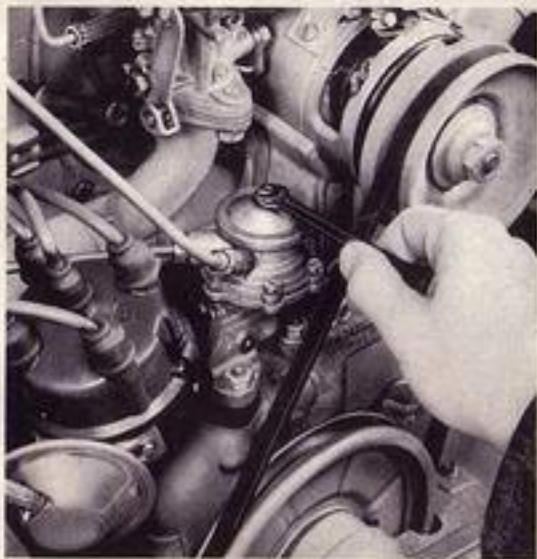

### **Carburetor Adjustment**

The carburetor is tested at the factory and properly adjusted to the engine. Do not alter this adjustment by exchanging the jets for other than the prescribed sizes. This would be detrimental under normal operating conditions and may result in hard starting, excessive fuel consumption or unsatisfactory engine performance. Only the idling speed may require occasional readjustment.



**Before attempting to adjust the carburetor, make sure the engine is at normal operating temperature.**

Check that the idling adjusting screw is no longer resting on the fast idle cam of the automatic choke.

- 1 - Turn the idling adjusting screw (1) in or out until an idling speed of about 550 rpm. has been attained.

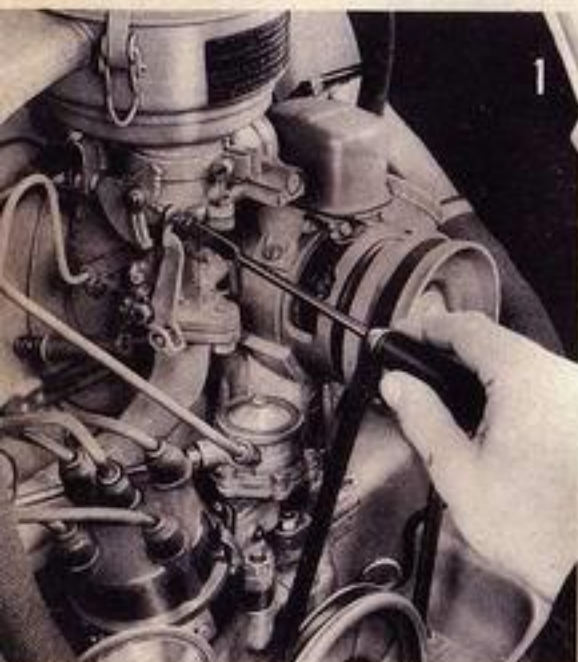

- 2 - Turn the volume control screw (2) clockwise until the engine speed begins to drop, then give it  $\frac{1}{4}$  to  $\frac{1}{3}$  of a turn in an anticlockwise direction.

- 3 - Re-adjust the idling adjusting screw.

The adjustment is correct if the engine does not stall when the throttle is either suddenly opened or shut with the clutch pedal depressed. Poor idling may also be the result of damaged gaskets, loose intake manifold flanges, faulty ignition or leaky valves. Skill and experience are required to check and adjust the carburetor with automatic choke and the accelerator pump. For this reason you should leave this job to an Authorized VW Workshop.

## Adjusting the Valves

The valves must only be adjusted when the engine is cold or slightly warm. The valve clearance is 0.20 mm. (.008") for the intake and exhaust valves.

When adjusting, both valves must be closed, i. e. the piston of the corresponding cylinder must be at T.D.C. on the compression stroke. The arrangement of the cylinders can be seen by the numbers 1 to 4 on the engine cover plates. Valve adjustment is carried out in the following sequence: cylinders 1, 2, 3, 4.

Remove distributor cap.

Crank the engine until the rotor arm points to the No. 1 cylinder mark on the rim of the distributor.

Remove cylinder head cover.

Loosen the adjusting screw lock nuts for the valves of No. 1 cylinder.

Adjust valve clearance with a feeler gauge.

Hold the adjusting screws and tighten the lock nuts.

To adjust the valves for cylinders No. 2, 3 and 4, turn the engine further anti-clockwise until the rotor arm is 90° offset each time.

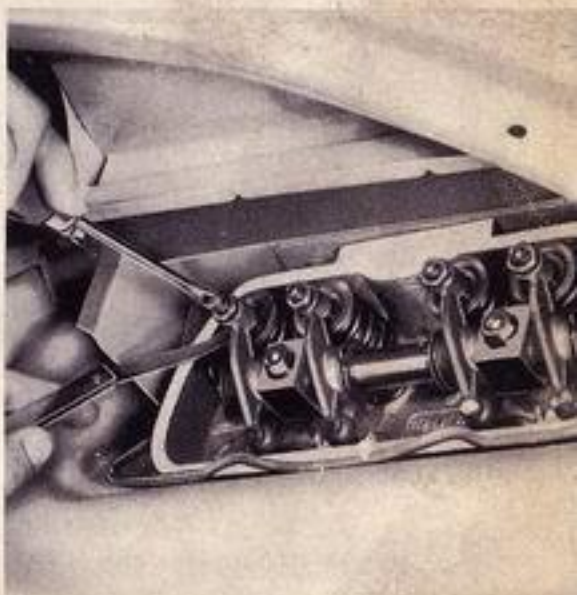
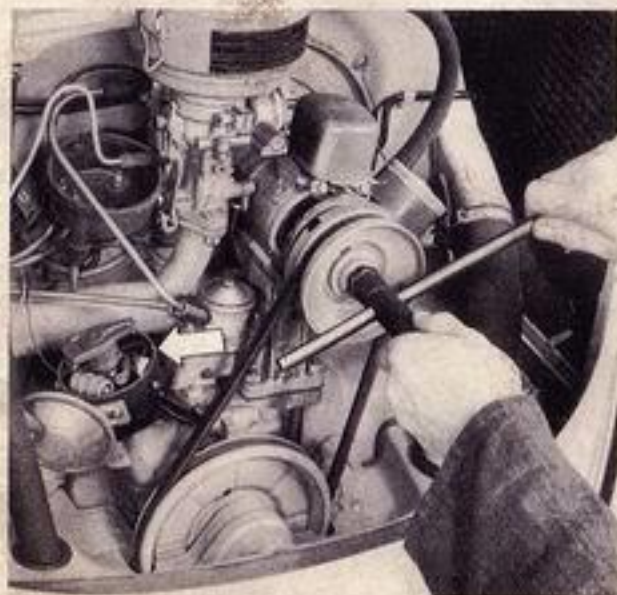

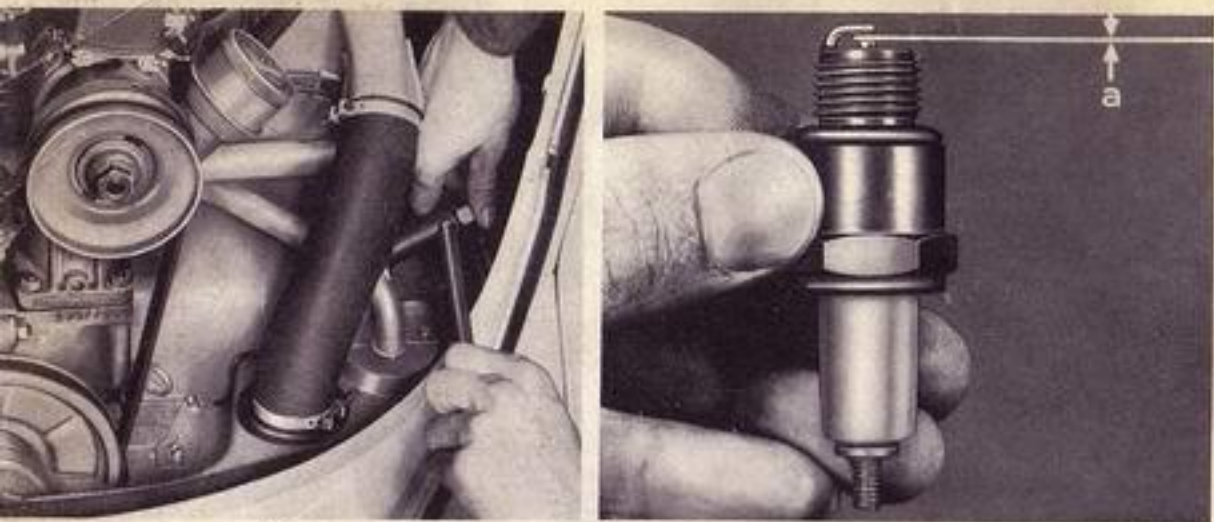

a = 0.7 mm. (.028")

### Checking the Spark Plugs

The plugs should be removed and inspected. The appearance of the electrodes and insulation gives valuable information on the adjustment and condition of the engine.

- medium grey – good adjustment of carburetor and correct performance of spark plug,
- black – mixture too rich,
- light grey – mixture too lean,
- oiled up – failure of spark plug or piston ring blow-by.

Clean the spark plugs with a brush and a chip of wood and blow them out. The insulator should be clean and dry on the outside in order to avoid short circuits and tracking.

Check the electrode gap (0.7 mm.) and reset if necessary by bending the outer electrode. Use a proper gasket when installing the plug. Generally speaking, you may count on a spark plug service life of up to 15,000 km. (9,000 miles).

### Checking Compression

After warming up the engine remove all four spark plugs. Operate the starter motor with the accelerator pedal fully depressed and the throttle in a wide-open position. The compression is checked by inserting an accurate compression gauge into the spark plug hole of each cylinder.

Result: good	7.0–9.0 kg./sq. cm. (100–128 lbs./sq. in.)
satisfactory	4.5–7.0 kg./sq. cm. (65–100 lbs./sq. in.)
poor	below 4.5 kg./sq. cm. (65 lbs./sq. in.)

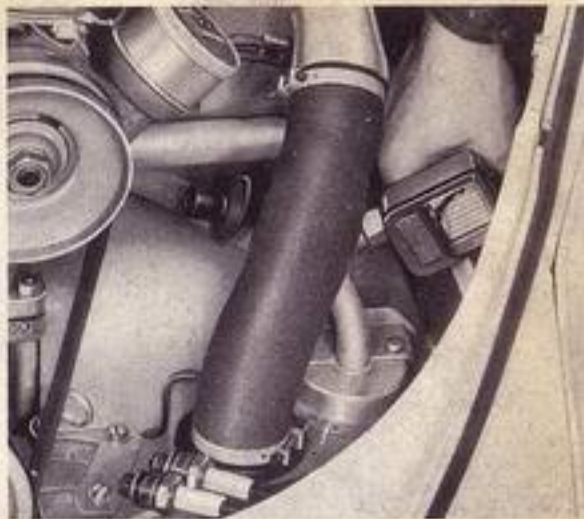

### Ignition timing

Particular attention must be paid to correct ignition timing. In many cases poor performance, high fuel consumption and even damage to the engine can be the result of incorrect ignition setting. The ignition must not be advanced arbitrarily even when using premium grade fuels.

Before setting the ignition timing the breaker contact point gap must be checked. With the breaker arm fully lifted the clearance should be 0.4 mm (.016"). The initial spark advance must be set to 10° before top dead centre.

The ignition timing must only be set with the engine cold or when it is slightly warm.

### Cleaning Contact Points

The contact points must be smooth and make even contact with each other. Dirty contacts should be cleaned and, if pitted, smoothed with a contact file. Whilst doing this, the contact points are pressed lightly together. Afterwards the ignition distributor should be blown out carefully with air. If the points are badly burnt they must be replaced.

### Lubricating Ignition Distributor

The breaker arm fiber block in the ignition distributor should always be lightly greased with Lithium grease. Every 5000 km. (3000 miles) check whether this location must be cleaned and provided with new grease. Only a very small amount of grease should be used and none of it must come in contact with the breaker points as otherwise the ignition will be affected. Every 5000 km., one drop of oil must be applied to the breaker base plate felt ring.



### Adjusting Contact Points

Remove distributor cap and rotor.

Turn the engine by means of the generator until the contact arm rests on the highest point of the cam lobe.

Loosen the breaker point locking screw.

Insert a screwdriver between the two lugs on the contact plate and the slot in the point carrier and adjust the gap to 0.4 mm. (.016").

Tighten locking screw and install rotor.

After the contact points have been adjusted, the ignition timing must be reset.

### Setting Ignition Timing

Crank the engine clockwise until the right-hand mark on the crankshaft pulley lines up with the crankcase joint and the distributor rotor arm is in line with the number 1 cylinder mark on rim of distributor.

Loosen clamp screw on distributor retainer.

Connect a 6 Volt test lamp to terminal 1 of the ignition coil and to ground.

Switch on ignition.

Rotate the distributor clockwise until the contact points are closed and then slowly anti-clockwise until the contact points just start to open and the test lamp comes on.

Tighten the clamping screw of distributor retainer.

Install distributor cap.

The ignition is correctly set if on cranking the engine slowly clockwise, the test lamp comes on when the right-hand mark on the crankshaft pulley is in line with the crankcase joint. Beforehand, the engine should be turned back anti-clockwise approximately a quarter of a revolution to take up the play in the distributor drive.

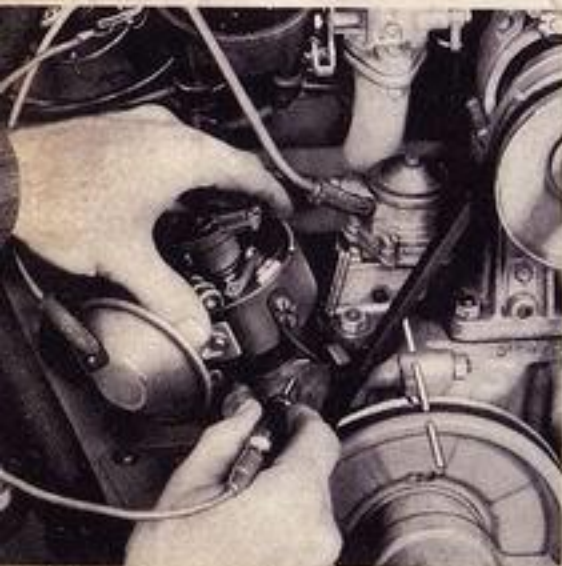

## Battery Maintenance

Ready starting of the engine depends upon the condition of the battery. The battery should, therefore, be checked and maintained regularly.

The battery cover can be easily removed by raising the rear seat, removing the kick board and opening the battery snap fastener. The battery should be checked with a cell tester. This is a voltmeter in parallel with a heavy resistance. The voltage of each cell should not fall below 1.6 volts while the reading is being taken (10-15 seconds). Otherwise the cell is discharged or defective. Under no-load conditions each charged cell should read 2.0 volts.



Add distilled water to each cell to bring the level above the plates. The acid level has to be adjusted in accordance with the acid level mark. Losses by evaporation may only be replenished by adding distilled water. Never add acid, unless it is known that acid has been spilled from the battery. Check specific gravity afterwards and compensate if necessary.

Check condition of the battery posts and the cable terminals. They must be clean and tight to prevent excessive electrical resistance. Use a stiff brush to remove corrosion from both posts and terminals. Coat the clean posts and terminals with light grease to prevent corrosion. Make sure that the battery is properly grounded.

When laying your vehicle up for a prolonged period, it is advisable to take the battery to a workshop for storage. A battery which is not in constant use will discharge itself in time and this can result in permanent damage to the plates if the battery is not checked about every 4 weeks and charged as necessary.

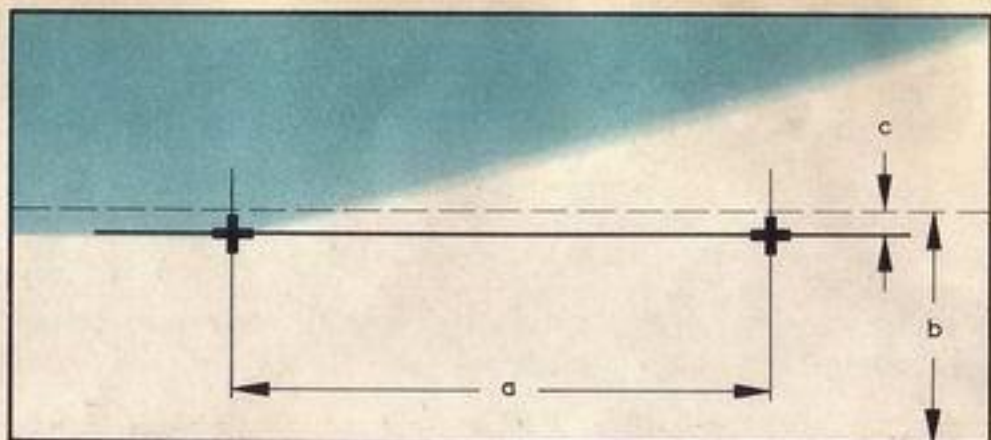

Dimensions:  $a = 1004 \text{ mm. (39.5")}$

$b =$  the height of the headlamp center from the floor

$c = 50 \text{ mm. (2")}$  at a distance of 5 meters (16 ft. 5") from the aiming screen

### Aiming the Headlights

If a headlight aiming device is not available, proceed as follows:

- 1 - Position the vehicle on level ground 5 m. (16 ft. 5 in.) in front of a dark wall which will serve as a screen. The tire pressures must be correct.
- 2 - Next draw two setting crosses and lines on the wall as shown in the sketch.
- 3 - The longitudinal center line of the vehicle must be aligned exactly between the two crosses on the screen.
- 4 - The rear seat must be loaded with one person or a weight of 70 kg. (154 lbs).
- 5 - The headlamps should be adjusted horizontally and vertically with the beams dimmed.
- 6 - Each lamp must be adjusted separately with the second lamp covered up.
- 7 - Adjust the headlamp by turning the slotted screws in the headlamp rim.



### Vertical Adjustment

The headlamps should be aimed vertically so that the light-dark border line is horizontally on the adjusting line to the left of the cross and slopes upward to the right of the cross.

### Horizontal Adjustment

The headlamps should be aimed horizontally so that the angle on light-dark border line is exactly on the center of the cross.



### Headlight Bulb Replacement

Loosen the slotted fixing screw at the bottom of the headlight rim. Pull out the lens and reflector unit. Turn the cap to the left and take the holder out of the reflector. Pull the connector off the bulb base and replace the bulb.

When installing the lamp unit check that:

- 1 - The lug in the lamp holder engages in the notch provided in the reflector.
- 2 - The contact strip is located on the base of the parking light bulb.

Never touch the bulb with the bare hand, but only with a clean cloth or a paper serviette, etc.





### **License Plate Light Bulb Replacement**

Open rear hood.

Remove screws on each side of lens and take off lens with bulb holder. Pull bulb holder out of lens.

Replace bulb.

On installation, ensure that the cable grommet fits properly.



### **Front Flashing Indicator Bulb Replacement**

Remove the Phillips screw, take off the housing and lens, and replace the bulb.



### **Replacing the Rear Indicator or Stop and Tail Light Bulbs**

Remove two Phillips screws, take out glass insert and replace damaged bulb:

Top - Indicator bulb

Bottom - Stop and tail light bulb

When replacing the stop and tail light bulb the retaining pin nearest to the bulb glass must point downwards. The Phillips screws in the glass insert should be tightened evenly but not excessively.

## Warning and Instrument Light Bulb Replacement

The warning lights for oil pressure, charging, flashing indicator and headlight high beam as well as the speedometer and fuel gauge lights are accessible after lifting the front hood and removing the cover at back of the instrument panel. The bulb sockets can easily be pulled out of their holders.

- 1 - Fuel gauge light
  - 2 - Speedometer lighting bulb
- Warning lamps:
- 3 - Headlights
  - 4 - Oil pressure
  - 5 - Flashing indicators
  - 6 - Generator

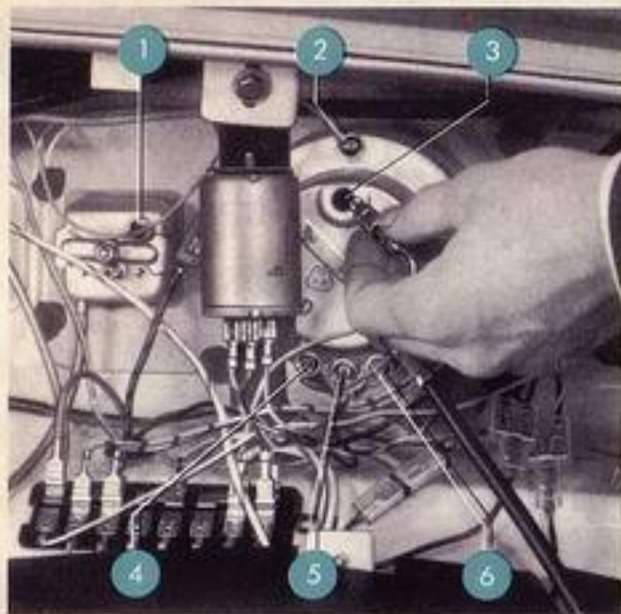

## Replacing Fuses

The fuse box, with transparent cover, is located under the instrument panel near the steering column.

When a fuse has blown, it is not sufficient merely to replace it with a new one. Inspect the electrical system for evidence of short circuits or other faults which may have caused the fuse to blow.

Under no circumstances use fuses which have been patched up with tin foil or wire as they would be liable to cause severe damage. We suggest that you always carry a few spare fuses (16 amp. for wipers, brake light, flasher relay and horn and 8 amp. for all other electrical equipment).

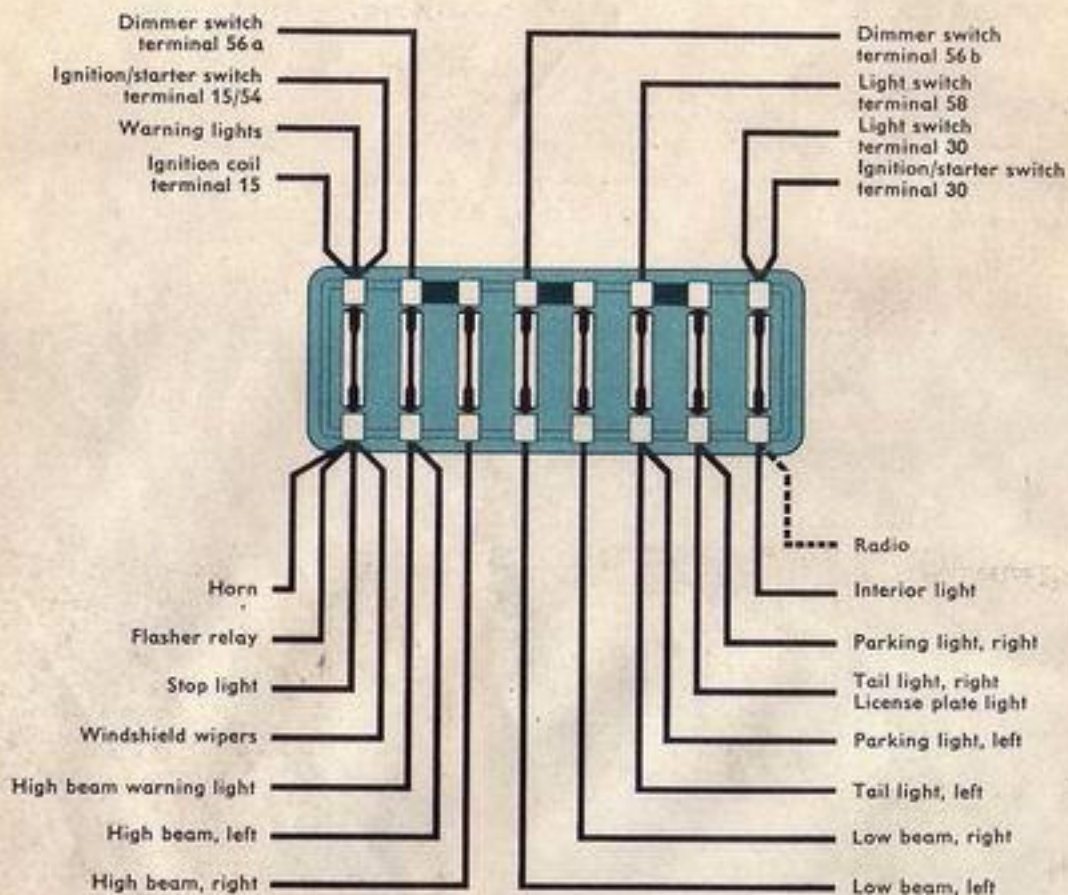

**Fuse box under the instrument panel**

## Checking Brakes

Excessive travel of the brake pedal before braking is affected indicates too much clearance between brake shoes and drum. You can check the brake linings by looking through the inspection hole in the brake drum. Inspect them every 5,000 km. (3,000 miles). They should be not less than 2.5 mm. (.1") thick. If they are badly worn, replace them.

## Hydraulic Brakes

Brake adjustment should be carried out in an Authorized VW Workshop. However, if an emergency arises where the brakes must be adjusted before you can reach the next repair shop, the following procedure is recommended.

The transparent fluid reservoir is located under the front hood behind the spare wheel. Use only **Genuine VW Brake Fluid** or **Lockheed Brake Fluid**. The fluid reservoir should be kept at least  $\frac{3}{4}$  full at all times. Handle the brake fluid carefully as it will damage the paintwork severely.

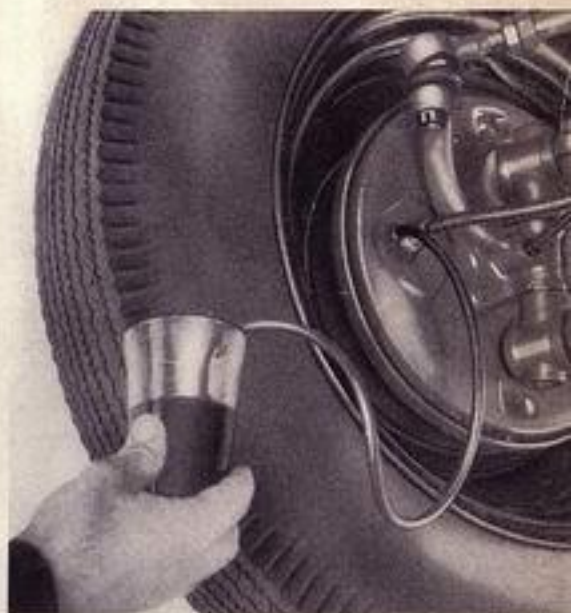
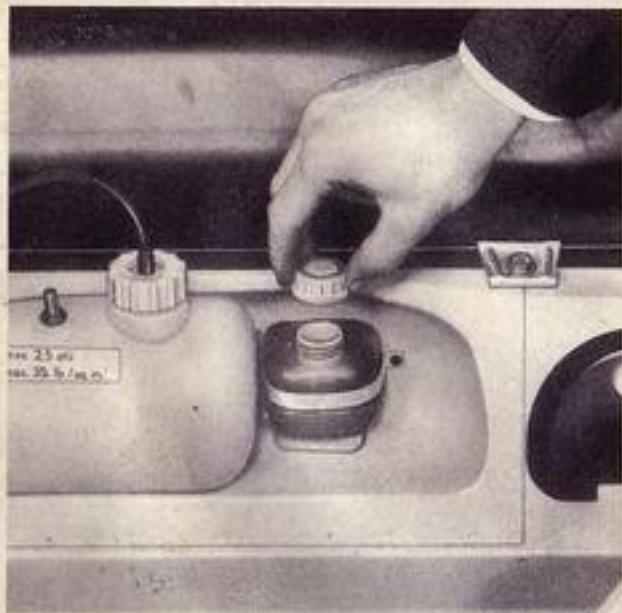

## Bleeding Brakes

Excessive brake pedal travel and sponginess indicates the presence of air in the system.

- 1 - Remove rubber cap of the bleeder valve of one wheel cylinder and attach one end of the brake bleeder hose to the valve.

- 2 - Place the opposite end of the bleeder hose in a glass container partly filled with brake fluid so that the end of the hose is submerged.
- 3 - Turn the bleeder valve to the open position ( $\frac{1}{2}$ -1 turn), using a 7 mm. wrench.
- 4 - Pump the brake pedal several times, forcing fluid through the lines until bubbles cease to appear in the container. Make sure that enough brake fluid remains in the fluid reservoir, since otherwise air will be sucked in.
- 5 - The brake pedal should be kept fully depressed until the bleeder valve is closed.
- 6 - Remove the bleeder hose and replace rubber cap.
- 7 - Repeat the above operations on the other wheels.  
When the bleeding is completed, top-up the master cylinder reservoir with brake fluid if necessary.



front



rear

### Adjusting Foot Brakes

Too much free travel at the brake pedal is an indication that the clearance between brake shoes and brake drums has become too great and that the brakes need adjusting or relining.

- 1 - Remove wheel caps.
- 2 - Jack up a wheel and turn it until the hole in the brake drum is in line with one of the adjusting nuts.
- 3 - Insert a screwdriver through the hole and turn the adjusting nut in the direction indicated by the arrow, using the screwdriver as a lever, until a slight drag is noted when wheel is turned by hand.
- 4 - Repeat procedure on the other adjusting nut. Note that the two nuts turn in opposite directions.
- 5 - Back off the adjusting nuts by 3 to 4 teeth until the wheel can be turned freely.
- 6 - Repeat the above operations on the other wheels.
- 7 - Install wheel caps and make sure they are tightly seated.

Before and after brake adjustment it is advisable to depress the brake pedal sharply to centralise the brake shoes.

When adjusting the rear brakes, the hand brake must be released.

### Adjusting Hand Brake

- 1 - Jack up both rear wheels.
- 2 - Fold back hand brake lever rubber boot.
- 3 - Tighten adjusting nuts on the front ends of the brake cables to a degree which will still allow the rear wheels to turn freely when the hand brake is released.
- 4 - Pull up hand brake lever two notches and make sure both rear wheels have the same braking effect. At the fourth notch it should be impossible to turn the wheels by hand. Lock the adjusting nuts.

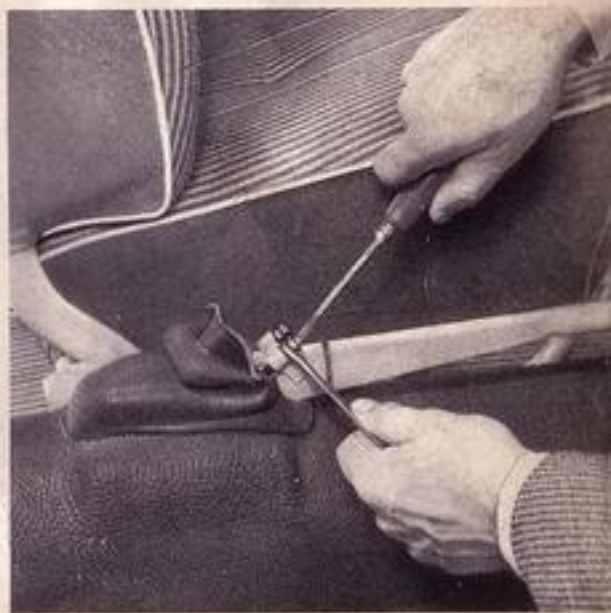

### Clutch Pedal Free-Play

Easy gear shifting and complete transmission of engine performance to gears and wheels can only be guaranteed if the clutch is adjusted as specified.

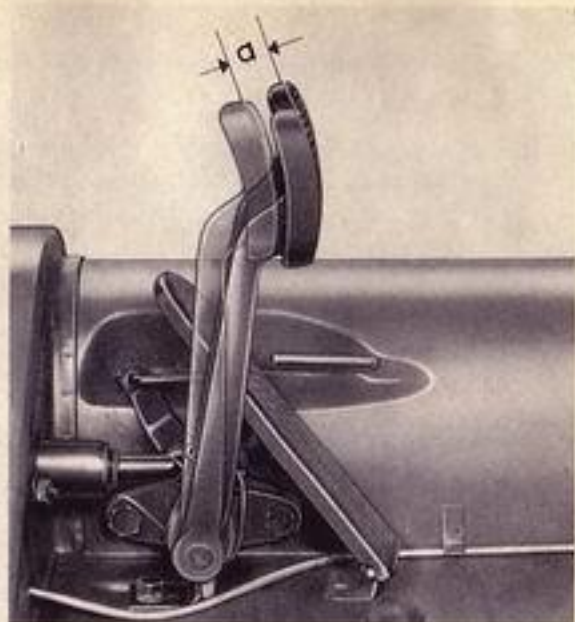

Measured at the clutch pedal, this free-play should be 10–20 mm. (0.4–0.8 in.) (a). The clearance may be adjusted at the adjusting nut on the cable end.

- 1 – Release lock nut on the threaded cable end.
- 2 – Adjust clutch clearance by turning the adjusting nut. Depress clutch pedal several times and recheck pedal free-play.
- 3 – When the correct adjustment has been reached, hold adjusting nut in position and tighten lock nut.
- 4 – Grease clutch cable adjusting nut with Universal Grease.

### **The Steering**

must be free of play in the straight ahead position. Moreover, the wheels must self-center after cornering.

To check the steering move the steering wheel to and fro. The steering is correctly adjusted if even the slightest movement of the steering wheel affects the front wheels.

Adjustments to the steering gear should only be carried out in a VW Workshop.

## Front Wheel Bearings

The front wheel bearings will occasionally require adjustment. We recommend that you refer this operation to an Authorized VW Workshop, as maladjustment may cause severe damage to the bearings.

If circumstances require the removal of a front brake drum, the front wheel bearings are to be adjusted as outlined below:

Tighten inner nut until the thrust washer can just be moved laterally with



a screw-driver and no bearing play can be felt when rocking the brake drum. Incorrect adjustment may ruin the bearings in a very short time. Finally, secure the nuts by bending down the lock plate.

## Checking and Adjusting Torsion Arm Link Pins

The torsion arm link pins should be checked and, if necessary, readjusted every 5,000 km. (3,000 miles).

The front end of the car should be raised so that the weight is taken off the wheels.

## Checking

Rock the wheel by hand to check for end play between torsion arm link and torsion arms. If play is present, adjust torsion arm link pins.





### Adjusting

- 1 - Grease torsion arm link pins thoroughly.
- 2 - Loosen pinch bolts at torsion arm eyes.
- 3 - Fully tighten link pins first, then back off about  $\frac{1}{4}$  of a turn.
- 4 - Tighten link pins until a slight resistance, caused by the pin shoulder contact, is felt.
- 5 - Tighten pinch bolts.

If the range of adjustment is insufficient, the shims are worn and should be replaced in a VW Workshop.

After the torsion arm link pins have been adjusted, it is absolutely necessary to check the toe-in.

### Checking toe-in

With the vehicle empty the toe-in should be 2-4 mm. (.08"-.16"). The adjustment of the front wheels can only be carried out satisfactorily in a workshop with the aid of a special gauge. If the wheels are not properly toed-in the result will be bad road holding and excessive tire wear.

### Convertible Door Windows

Vertical adjustment of the door windows on the Convertible is carried out with stop screws, which are accessible after removing the door trim panels. The lock nut of the stop screw is to be loosened before an adjustment is made.

### Adjustment of Door Lock

There is no need to adjust the Volkswagen door locks regularly. If the door rattles or jams the wedge can easily be adjusted.

- 1 - Check the 3 striker plate screws for security. Tighten if necessary.

Adjust the striker plate so that door and pillars are a flush fit. The lock housing on the door must have about the same clearance at top and bottom when sliding into the striker plate.

- 2 - Hold the adjusting screw with a screwdriver and tighten lock nut with an 11 mm. wrench.



- 3 - Turn the adjusting screw to the left if the door is rattling and to the right if it jams. A quarter to half a turn will usually suffice to bring the shoulder for the wedge into the proper position.

- 4 - The locking device is properly adjusted if resistance can be felt when opening the door with the inside handle. If, however, there is too much resistance or if the door jumps open on its own, turn the shoulder back slightly. This is done by turning the adjusting screw to the right.

- 5 - After adjustment, hold the screw with a screwdriver and tighten lock nut.

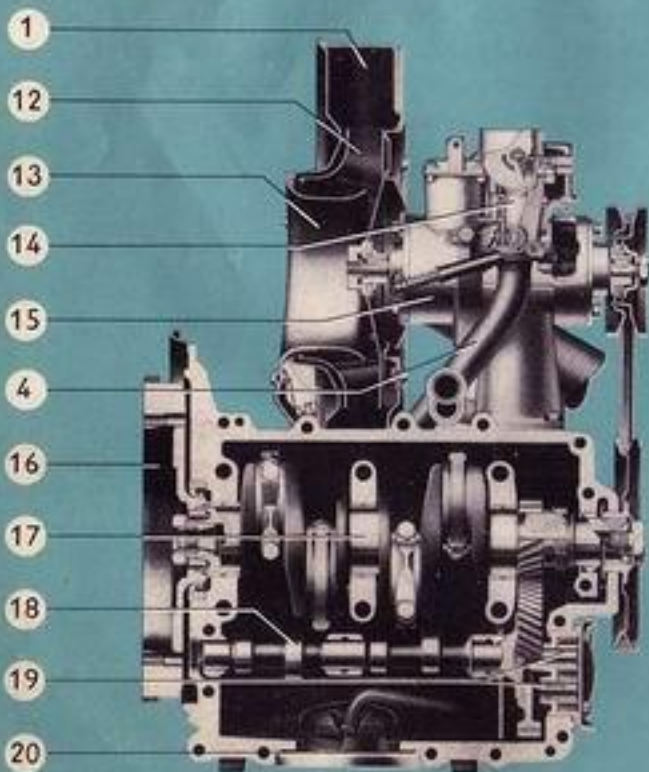
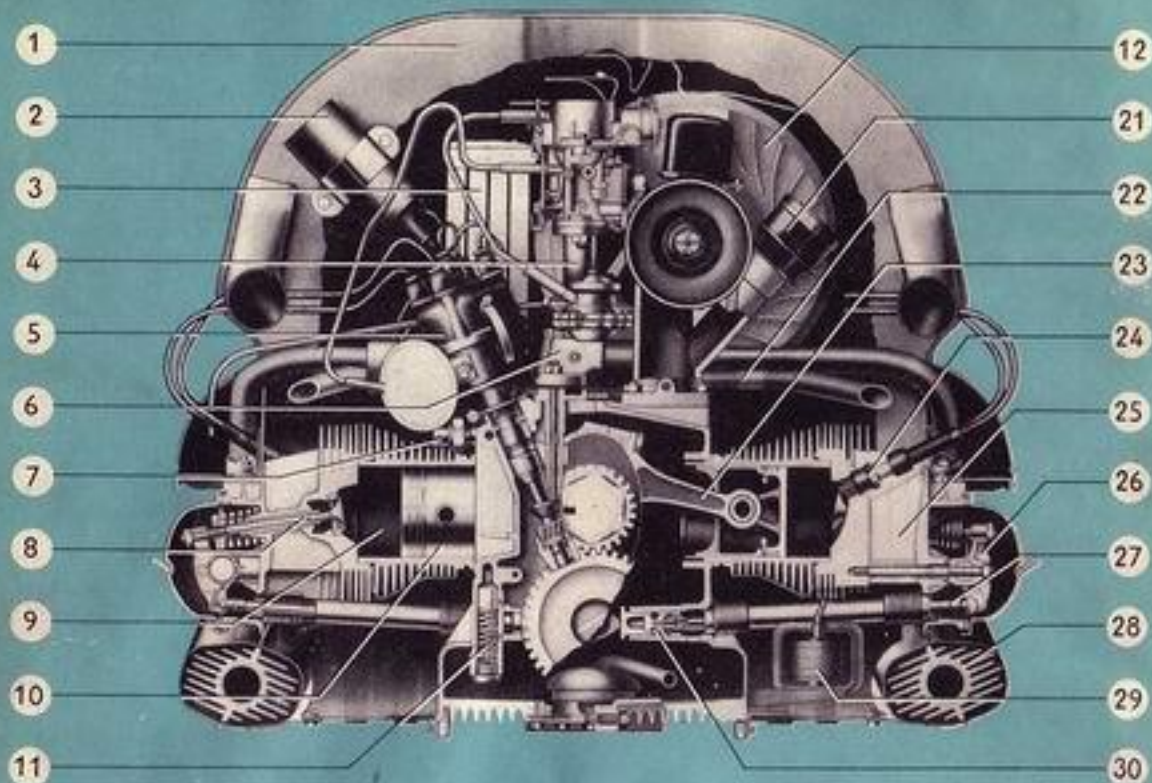

## Engine

- |                         |                                |
|-------------------------|--------------------------------|
| 1 - Fan housing         | 10 - Piston                    |
| 2 - Ignition coil       | 11 - Oil pressure relief valve |
| 3 - Oil cooler          | 12 - Fan                       |
| 4 - Intake manifold     | 13 - Throttle ring             |
| 5 - Distributor         | 14 - Carburetor                |
| 6 - Fuel pump           | 15 - Generator                 |
| 7 - Oil pressure switch | 16 - Flywheel                  |
| 8 - Valve               | 17 - Crankshaft                |
| 9 - Cylinder            | 18 - Camshaft                  |
|                         | 19 - Oil pump                  |
|                         | 20 - Oil strainer              |
|                         | 21 - Oil filler and breather   |
|                         | 22 - Pre-heating pipe          |
|                         | 23 - Connecting rod            |
|                         | 24 - Spark plug                |
|                         | 25 - Cylinder head             |
|                         | 26 - Rocker arm                |
|                         | 27 - Push rod                  |
|                         | 28 - Heat exchanger            |
|                         | 29 - Thermostat                |
|                         | 30 - Cam follower              |

# GENERAL DESCRIPTION

## Engine

The engine, located in the rear of the car, is attached by 4 bolts to the recessed flange of the rubber mounted transmission case. Two pairs of cylinders are horizontally opposed. Each pair has a common cylinder head made of light alloy. The overhead valves are located in the cylinder head and are operated by the camshaft via cam followers, push rods and rocker arms. The short and counter-balanced crankshaft rests in four special light alloy bearings and is heat-treated at its four points of support. It drives the camshaft by means of helical gears. The connecting rods are fitted with lead-bronze bearings. The pistons are made of aluminium alloy.

A down-draft carburetor with automatic choke and accelerator pump supplies the fuel-air mixture to the cylinders. The engine is equipped with battery ignition.

The spark advance is controlled automatically by a vacuum mechanism.

The oil pump of the pressure lubrication system is driven by the camshaft and sucks the oil from the crankcase through a strainer and pumps it to the various lubrication points via an oil cooler. In cold weather, when the oil is thicker, an oil pressure relief valve makes it possible for the engine to be lubricated directly, that is, by allowing the oil to by-pass the oil-cooler. The air cooling of the engine is done by means of a fan, which is attached to the extended generator shaft and driven from the crankshaft by an adjustable V-belt. The fan sucks in air through an opening in the fan housing, and the air cools the engine by passing through fins. The flow of cooling air is regulated by a thermostat and this ensures a constant operating temperature.

## Chassis

The frame of the Volkswagen is of pressed steel. The steel floor of the frame is formed in two pieces. These two pieces are spot-welded together with the channel shaped center section of the frame, the forked rear end of which serves to support the transmission and engine unit. The following parts pass through the center of the frame:

Gearshift rod, fuel line, and, in guide tubes, the cables of hand brake, clutch, throttle, and heating control cables.

The front suspension is an independent parallel arm type, using torsion bar springs. The front axle is bolted to the front end of the frame and consists of two rigidly joined tubes, which carry the torsion bar springs

and the upper and lower arms of the front wheel suspension. A stabilizer is attached to both lower torsion arms. The steering gear acts on the front wheels via a divided tie-rod. A steering damper ensures steering steadiness. The rear axle is of the swinging half axle design. The rear wheels likewise are independently sprung, using one individual torsion bar spring on each side. Double-acting hydraulic shock absorbers in front and rear prevent excessive rebound.

### **Transmission and Rear Axle**

Power from the engine is transmitted to the gears via a dry single-plate clutch. The transmission case houses the gearbox with four forward speeds, one reverse, and the differential.

The vehicle is equipped with synchromesh on all forward gears. The gears are helically cut to provide silent operation.

The drive pinion and the ring gear are cut spirally. The two swinging rear axle shafts are flexibly supported in the differential housing.

### **Brakes**

The hydraulic foot brakes operate on all wheels, and the handbrake, via cables, on the rear wheels.

### **Body**

The basic structure of the Volkswagen is made of pressed steel panels, electrically welded together and strongly reinforced to provide maximum rigidity. Draft-free ventilation by means of vent wings is provided on both door windows. Both front seats can easily be adjusted even when the car is in motion. The front hood lock is released by pulling a knob. The fuel tank and the spare wheel are located underneath the front hood. Luggage space is provided behind the rear seats and under the front hood.

### **Heating System**

The fresh air drawn in by the cooling fan is heated by heat exchangers and passes into the vehicle interior through two defroster vents at the windshield and two controllable outlets in front and rear foot wells. The heating can be regulated by a rotary knob situated on the frame tunnel near the driving seat.

## Rear Axle and Transmission

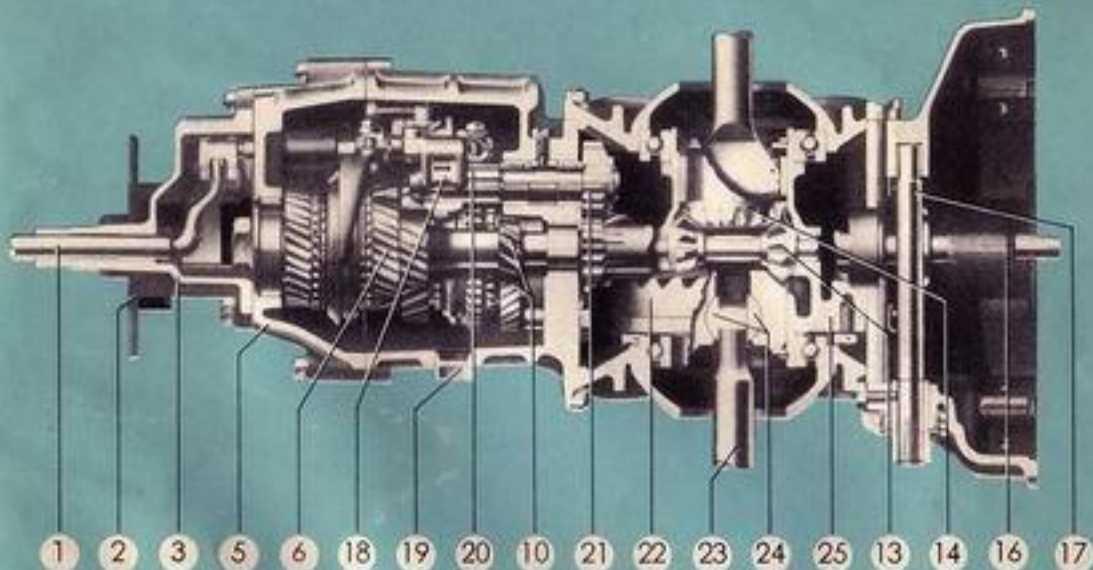
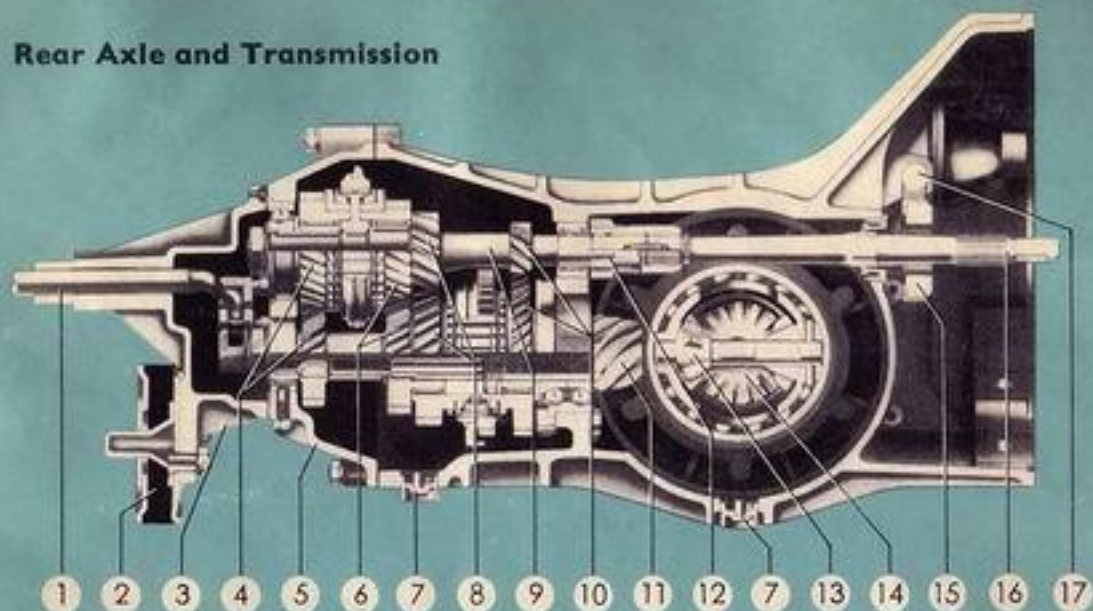

- 1 - Transmission shift lever
- 2 - Bonded rubber mounting
- 3 - Gearshift housing
- 4 - 4th speed
- 5 - Gear carrier
- 6 - 3rd speed
- 7 - Oil drain plugs
- 8 - 2nd speed
- 9 - Main drive shaft, front

- 10 - 1st speed
- 11 - Drive pinion
- 12 - Reverse gear
- 13 - Differential pinion
- 14 - Differential side gear
- 15 - Clutch release bearing
- 16 - Main drive shaft, rear
- 17 - Clutch operating shaft

- 18 - Reverse sliding gear
- 19 - Oil filler plug
- 20 - Reverse shaft
- 21 - Reverse drive gear
- 22 - Ring gear
- 23 - Rear axle shaft
- 24 - Fulcrum plate
- 25 - Differential housing



## TECHNICAL DATA

### Engine

Design . . . . .	4 Cylinder, 4 Cycle, O.H.V.-Type, in rear of car	
Arrangement of Cylinders . . . . .	Horizontally opposed (Flat Four)	
Bore . . . . .	77 mm. (3.031")	
Stroke . . . . .	64 mm. (2.520")	
Capacity . . . . .	1192 c.c. (72.740 cu. in.)	
Compression Ratio . . . . .	7.0 : 1	
Valve Clearance . . . . .	Intake 0.20 mm. (.008")	} to be adjusted when engine is cold
	Exhaust 0.20 mm. (.008")	
Brake Horsepower (SAE) . . . . .	40 at 3900 rpm.	
Lubrication . . . . .	Force Feed (Gear Pump) with Oil Cooler	
Oil Capacity . . . . .	Metric - 2.5 liters U.S. - 5.3 pints Imp. - 4.4 pints	
Fuel Pump . . . . .	Diaphragm Type	
Carburetor . . . . .	Down-Draft Type, Solex 28 PICT	
Cooling System . . . . .	Air Cooling by Fan, thermostat controlled	
Battery . . . . .	6 Volts, 66 Ampere Hours	
Starting Motor . . . . .	Electric, 6 Volts, 0.5 HP.	

Generator . . . . .	Voltage regulating, 6 Volts, 180 Watts at 2500 rpm.
Ignition Distributor . . . . .	with Vacuum Spark Advance
Firing Order . . . . .	1-4-3-2
Initial Spark Advance . . . . .	10° before T.D.C.
Breaker Point Gap . . . . .	0.4 mm. (.016")
Spark Plugs . . . . .	14 mm. thread Bosch W 175 T 1 Beru 175/14 Champion L 85 and plugs of similar values from other manufacturers
Spark Plug Gap . . . . .	0.7 mm. (.028")

### Clutch

Design . . . . .	Single Plate, dry
Pedal Free-Play . . . . .	10 to 20 mm. (.4"-.8")

### Transmission

4 Forward Speeds, 1 Reverse

All forward gears synchronized and silent.

Gear Ratios . . . . .	First	3.80 : 1	Third	1.32 : 1
	Second	2.06 : 1	Fourth	0.89 : 1
			Reverse	3.88 : 1

### Rear Axle

Power is transmitted through a spiral drive pinion and ring gear, via two swinging axles to the rear wheels.

Ratio . . . . . 4.375 : 1

Oil Capacity of Transmission

and Rear Axle . . . . .	Metric - 3.0 liters
	U.S. - 6.3 pints
	Imp. - 5.3 pints



## Chassis

Springs, Front . . . . .	Two Torsion Bars
Rear . . . . .	Two Torsion Bars
Shock Absorbers . . . . .	Double Acting Telescopic Type, Front and Rear
Steering . . . . .	Roller Steering Gear, divided Tie Rod and Hydraulic Steering Damper
Turns of Steering Wheel,	
Lock to Lock . . . . .	2.6
Turning Circle . . . . .	about 11 m. (36 ft.)
Wheels . . . . .	Disc Wheels 4 J x 15, Drop-Center Type
Tires . . . . .	5.60-15, tubeless
Inflation Pressure	
1 to 2 Occupants . . . . .	Front: 1.1 kg./sq. cm. Rear: 1.4 kg./sq. cm. 16 lbs./sq. in.           20 lbs./sq. in.
3 to 5 Occupants . . . . .	Front: 1.2 kg./sq. cm. Rear: 1.7 kg./sq. cm. 17 lbs./sq. in.           24 lbs./sq. in.
Wheel Base . . . . .	2,400 mm. (94.5 in.)
Track (Tread) . . . . .	Front: 1,305 mm. (51.4 in.) Rear: 1,288 mm. (50.7 in.)
Toe-in (car unloaded) . . . . .	2 to 4 mm. (0.08 in. to 0.16 in.)

## Brakes

Foot Brake . . . . .	Hydraulic, Operating on All Wheels
Hand Brake . . . . .	Mechanical, Operating on Rear Wheels

## Dimensions and Weights

Length . . . . .	4,070 mm. (13 ft. 4 in.)
Width . . . . .	1,540 mm. (5 ft. 0.6 in.)
Height . . . . .	1,500 mm. (4 ft. 11 in.)
Ground Clearance . . . . .	152 mm. (6.0 in.)

	Sedan	Convertible
Unladen Weight, Ready for Use . . . . .	760 kg. (1675 lbs.)	810 kg. (1785 lbs.)
Max. Load . . . . .	380 kg. ( 838 lbs.)	360 kg. ( 794 lbs.)
Permissible Total Weight . . . . .	1140 kg. (2513 lbs.)	1170 kg. (2579 lbs.)
Max. Load on Front Axle . . . . .	480 kg. (1058 lbs.)	480 kg. (1058 lbs.)
Max. Load on Rear Axle . . . . .	700 kg. (1543 lbs.)	700 kg. (1543 lbs.)

## Fuel Consumption

### Standard Consumption

according to DIN 70030 . . . Metric - 7.5 liters per 100 km.  
U.S. - 31.5 miles per gallon  
Imp. - 37.5 miles per gallon

(Consumption plus 10% at half the load and at a steady  $\frac{3}{4}$  of top speed 86 kph./53 mph. on level road.)

Oil Consumption . . . . . 0.3-1.0 liter per 1,000 km. (600 miles)  
1.0-3.4 U.S. pints per 1,000 miles  
0.9-2.8 Imp. pints per 1,000 miles

## Refill Requirements

Fuel Tank . . . . . 40 liters (10.6 U.S. gall.; 8.8 Imp. gall.)  
Engine . . . . . 2.5 liters (5.3 U.S. pints; 4.4 Imp. pints)  
Rear Axle and Transmission . 2.5 liters (5.3 U.S. pints; 4.4 Imp. pints)  
Steering Gear Case . . . . . 0.16 liter (0.34 U.S. pint; 0.28 Imp. pint)  
Brakes . . . . . 0.25 liter (0.53 U.S. pint; 0.44 Imp. pint)  
Container for windshield washer . . . . . approx. 1 liter (1 qt.)  
Oil bath air cleaner . . . . . 0.25 liter (0.53 U.S. pint; 0.44 Imp. pint)

## Performance

Maximum and Cruising Speed 115 kph. (72 mph.)

	Sedan	Convertible
Hill-Climbing Ability . . . . .	First Gear 43.5 %	39.0%
	Second Gear 22.5 %	20.5%
	Third Gear 13.5 %	12.0%
	Fourth Gear 7.5 %	6.5%

## Bulb Chart V = Volts, W = Watts

Light Description	Description of Bulb (according to German Standard DIN 72601)	Spare Part No.
Headlights . . . . .	A 6 V 45/40 W	N 177051
Parking Lights . . . . .	HL 6 V 4 W	N 177171
Stop/Tail Lights . . . . .	S 6 V 18/5 W	N 177371
License Plate Light . . . . .	G 6 V 5 W	N 177181
Speedometer, Fuel Gauge and Warning Lights . . . . .	J 6 V 1.2 W	N 177221
Interior Light . . . . .	K 6 V 10 W	N 177231
Flashing Indicator Lights . . . . .	R 6 V 18 W	N 177311

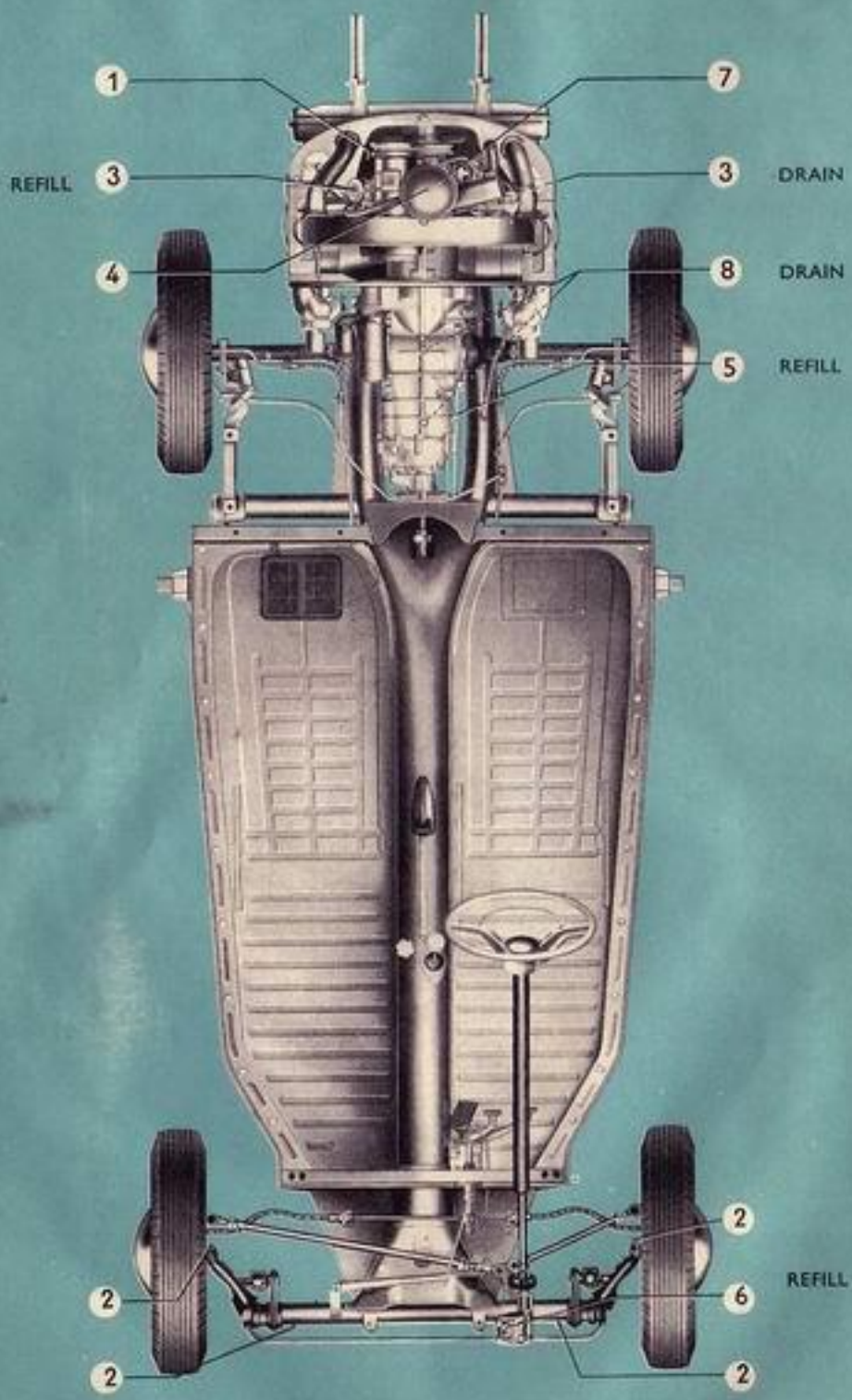

## LUBRICATION CHART

500 km. 300 miles	2,500 km. 1,500 miles	5,000 km. 3,000 miles	No.	Lubrication Points	Every
			1	Engine: Check oil level	<b>2,500 km. 1,500 miles</b>
			2	Front axle: Lubricate	
				Door hinges	
			3	Engine: Change oil, clean oil strainer	<b>5,000 km. 3,000 miles</b>
			4	Check air cleaner: Clean lower part if necessary	
			5	Transmission: Check oil level	
			6	Steering gear: Check oil level	
			7	Carburetor controls	
				Door and hood locks	
			8/5	Transmission: Change oil, clean magnetic oil drain plugs	<b>50,000 km. 30,000 miles</b>

## LUBRICANTS

Lubricant	Lubrication Points	Specifications	
		Temperature °C	Temperature °F / Viscosity class
Engine oil (HD oil for spark ignition engines)	Engine, oil bath air cleaner, carburetor linkage, door hinges, Felt ring in contact breaker base plate	above	30 86 SAE 30
		from	0 32 SAE 20 W / 20
		up to	30 86
		below	0 32 SAE 10 W
		below -	25 - 13 SAE 5 W
Hypoid Oil	Transmission	all the year SAE 90*)	
	Steering gear	all the year SAE 90	
Universal grease	Torsion arms, king pins and torsion arm link pins, door and hood locks,	cold-resistant water-repellent high pressure grease	
Lithium grease	Front wheel bearings, Breaker arm fiber block in distributor	Multi-purpose grease	

\*) SAE 80 all the year in countries with arctic climates.

# MAINTENANCE CHART

500 km. 300 miles	5,000 km. 3,000 miles	Operation	Every
		Check for tightness: Nuts and bolts on chassis, body, engine, rear axle, front axle, and steering	
		Check rear axle and engine for leaks	
		Check tire pressure and wheel mounting bolts for tightness	
		Check front wheel bearing play	
	5,000 km. 3,000 miles	Check fan belt	
		Clean fuel pump filter Lubricate felt ring of contact breaker base plate	
		Check breaker points, grease distributor, check contact breaker points and timing	
		Check valve clearance	
		Check spark plugs and compression pressures	
		Check rubber valve for crankcase ventilation, check exhaust system for damage	
		Check clutch pedal free-play	
		Check torsion arm link pins, tie rod end dust seals, tie rod ends, steering damper mounting and toe-in	
		Check steering adjustment	
		Check tire wear, damage and pressure	
		Check hydraulic brake system for leaks and damage. Check brake fluid level and adjustment of hand and foot brakes	
		Check thickness of brake linings through inspection hole Check shock absorbers for secure mounting	
		Check battery Check operation of complete electrical system and headlight alignment Check adjustment of doors	
		Road test vehicle, check foot and hand brake efficiency. Check idling adjustment and heating	
		Clean, grease and adjust front wheel bearings	50,000 km. 30,000 miles

# INDEX

	Page		Page
Accelerating - right and wrong . . . . .	27	Driving the Volkswagen . . . . .	14
Accelerator pedal . . . . .	7	Driving down-hill . . . . .	17
Accessories . . . . .	III	<b>Economy</b> . . . . .	27
Air cleaner - cleaning . . . . .	53	Engine - compression ratio . . . . .	78
Ash tray . . . . .	20	- description . . . . .	75
<b>Battery</b> - maintenance . . . . .	60	- design . . . . .	78
- care in winter . . . . .	34	- lubrication (oil change) . . . . .	35
Body - airing the interior . . . . .	52	- oil change in winter . . . . .	33
- description . . . . .	76	- oil level . . . . .	10
Brakes - adjusting . . . . .	68	- oil strainer . . . . .	36
- application . . . . .	16	- speed . . . . .	81
- bleeding . . . . .	67	- sectional view . . . . .	74
- care in winter . . . . .	33	- technical data . . . . .	78
- checking . . . . .	12	- type of oil . . . . .	33
- description . . . . .	76	<b>Fan belt</b> - adjusting . . . . .	54
Brake pedal . . . . .	7	- checking tension . . . . .	10
Breaking-in (running-in) period . . . . .	26	Flashing indicator switch . . . . .	7
<b>Carburetor</b> adjusting . . . . .	56	Foot brake - adjusting . . . . .	68/69
- type . . . . .	78	- description . . . . .	76
Care of the car . . . . .	46	Front axle - description . . . . .	75
Chassis - care in winter . . . . .	33	- lubrication . . . . .	40
- description . . . . .	75	- technical data . . . . .	80
Chassis number . . . . .	8	Front seats - adjustment . . . . .	18
Chromium-plated parts - care . . . . .	50	- lubrication of seat runners . . . . .	41
Climbing ability . . . . .	81	Front wheel bearings - adjusting . . . . .	71
Clutch - design . . . . .	79	- lubrication . . . . .	40
- pedal . . . . .	7	Fuel consumption . . . . .	81
- pedal free-play . . . . .	79	Fuel filter-cleaning . . . . .	55/56
Cold weather hints . . . . .	32	Fuel tank - capacity . . . . .	11/81
Compression . . . . .	59	- reserve . . . . .	11
Controls and instruments . . . . .	7	Fuel gauge . . . . .	11
Cooling of engine . . . . .	78	Fuse box . . . . .	66
<b>Dimensions</b> - overall . . . . .	80	Fuses-replacing . . . . .	65
Dimmer switch - headlight . . . . .	7	<b>Gear lever</b> . . . . .	7
Doors - care of weather strips . . . . .	51	Gear shifting on gradients . . . . .	27
- inside handle . . . . .	7	Generator . . . . .	79
- lubrication points . . . . .	40	Ground clearance . . . . .	80

	Page		Page
Hand brake – adjusting . . . . .	69	Passing other cars . . . . .	30
– description . . . . .	76	Practical driving . . . . .	26
Headlight – aiming . . . . .	62		
– changing bulb . . . . .	63	Ratios – rear axle . . . . .	79
Heating – description . . . . .	76	– transmission . . . . .	79
– operation . . . . .	32	Rear axle – description . . . . .	76
Hood lock – control knob . . . . .	7	– technical data . . . . .	79
– Convertible . . . . .	22	– transmission of power . . . . .	79
Horn lever . . . . .	7	Rear seat back . . . . .	21
Identification plate . . . . .	8	Rear view mirror . . . . .	30
Idling – checking and adjusting . . . . .	56	Reverse gear . . . . .	15
Ignition – breaker point gap . . . . .	59		
– distributor . . . . .	79	Safety belts . . . . .	18
– firing order . . . . .	79	Safety in traffic . . . . .	30
– lubrication of distributor . . . . .	38	Seat adjustment . . . . .	18
– timing . . . . .	59	Sectional view with explanations . . . . .	88
Instrument light . . . . .	12	Shifting gears . . . . .	15
Interior light . . . . .	20	Shock absorbers – design . . . . .	80
Jack – application . . . . .	45	Spare wheel . . . . .	45
– location . . . . .	22	Spark plugs – checking and cleaning . . . . .	58
Keys . . . . .	8	– gap . . . . .	58
		– removal . . . . .	58
License plate light – replacing bulb . . . . .	64	Speedometer . . . . .	7
Light switch – positions . . . . .	12	Speed ranges . . . . .	26
Lubricants . . . . .	83	Spots – removal . . . . .	49
Lubrication . . . . .	35	Starting – danger in enclosed spaces . . . . .	14
Lubrication chart . . . . .	83	– with temperatures under	
Maintenance . . . . .	53	freezing point . . . . .	14
Maintenance chart . . . . .	84	– with temperatures above	
Maximum output . . . . .	78	freezing point . . . . .	13
Maximum speed . . . . .	81	Starting motor . . . . .	78
Non-skid chains . . . . .	34	Steering – ignition lock . . . . .	31
Oil consumption . . . . .	81	Steering – checking . . . . .	70
Oil level – engine . . . . .	10	– type . . . . .	80
– steering gear . . . . .	39	Stop light – bulb replacement . . . . .	64
– transmission . . . . .	38	– checking . . . . .	13
Paintwork – preservation . . . . .	47	Stopping the car – general . . . . .	17
– polishing . . . . .	48	– temporarily . . . . .	30
Parking your car . . . . .	31	Sun roof – opening and closing . . . . .	23
		Suspension – front . . . . .	80
		– rear . . . . .	80

	Page		Page
Tail light - replacing bulb . . . . .	64	Valves - adjusting . . . . .	57
Technical data . . . . .	78	- arrangement . . . . .	78
Tires - inflation pressure . . . . .	12	- clearance . . . . .	78
- maintenance . . . . .	43	Vent wing . . . . .	7
- M+S tires . . . . .	34		
- size . . . . .	80	Warning lights - flashing indicator . . . . .	29
- wear . . . . .	43	- generator and cooling . . . . .	29
Toe-in of front wheels . . . . .	80	- headlight . . . . .	29
Tools and accessories . . . . .	III	- oil pressure . . . . .	29
Track (tread) . . . . .	80	- replacing bulbs . . . . .	64
Transmission - description . . . . .	76	Washing your car . . . . .	47
- oil change and capacity . . . . .	38	Weights . . . . .	80
- sectional view . . . . .	77	Wheel base . . . . .	80
- technical data . . . . .	79	Wheels - balancing . . . . .	44
Turning circle . . . . .	80	- changing . . . . .	44
Type of fuel . . . . .	11	- rim size . . . . .	80
		Window regulator handle . . . . .	7
Upholstery - care of cloth . . . . .	50	Window weather strips - care . . . . .	51
- leatherette . . . . .	51	Windshield wiper switch . . . . .	7





(503) 386-6613

Payson Int - Call collect

Northwood  
Realty

474-5226

Ray Carr

### VW SEDAN, SECTIONED

- 1 Spare tire and wheel
- 2 Brake fluid reservoir
- 3 Steering gear
- 4 Front axle and square torsion bars
- 5 Float (Fuel gauge)
- 6 Fuel tank
- 7 Brake master cylinder
- 8 Pedal linkage
- 9 Speedometer
- 10 Gear lever
- 11 Heating control
- 12 Flashing indicator switch
- 13 Hand brake lever
- 14 Vent wing handle
- 15 Battery
- 16 Socket for car jack
- 17 Rear torsion bar
- 18 Transmission
- 19 Starting motor
- 20 Differential
- 21 Clutch
- 22 Shock absorber
- 23 Crankshaft
- 24 Camshaft
- 25 Oil strainer
- 26 Fan housing
- 27 Oil pump
- 28 Generator
- 29 Muffler
- 30 Carburetor
- 31 Oil bath air cleaner

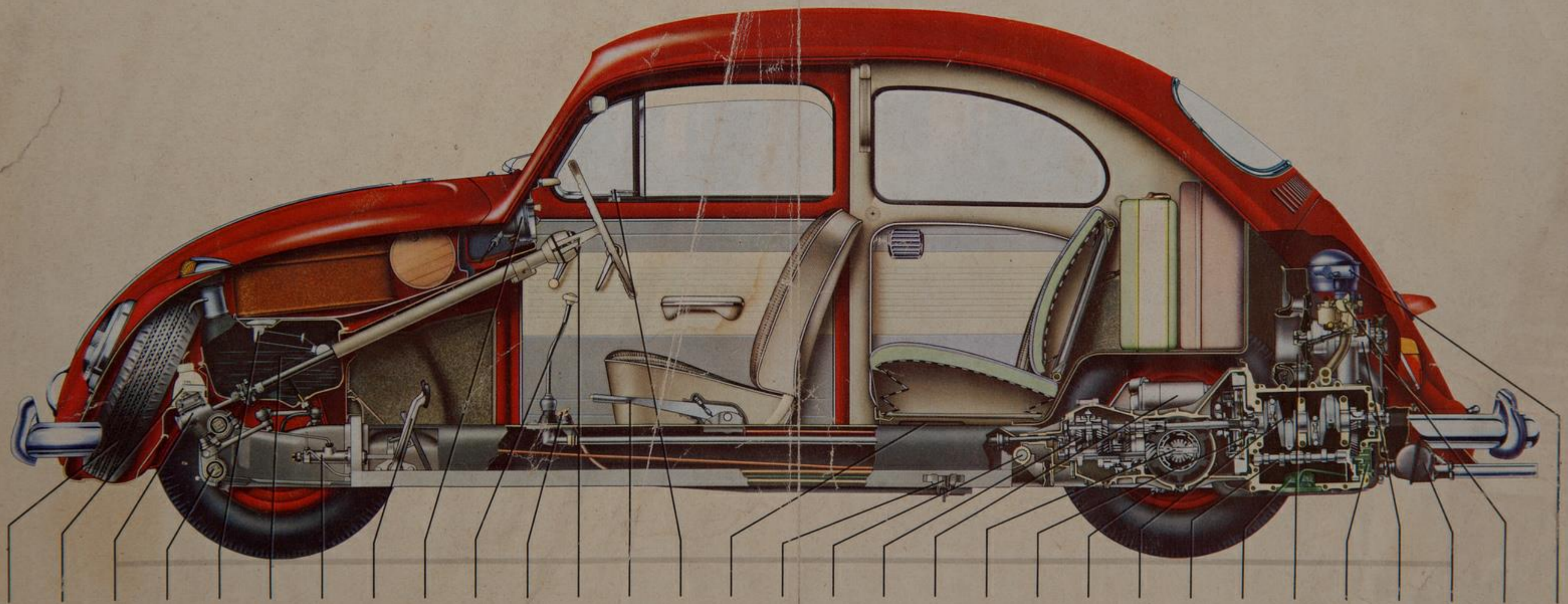

1 2 3 4 5 6 7 8 9 10 11 12 13 14 15 16 17 18 19 20 21 22 23 24 25 26 27 28 29 30 31

