

# *Instruction Manual*

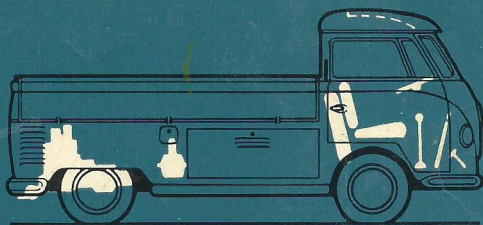

*Transporter*

M A R C H 1 9 5 6



# INSTRUCTION MANUAL

# VW TRANSPORTER

## CONTENTS

|                              |    |
|------------------------------|----|
| Preface .....                | 3  |
| Driver's Controls .....      | 5  |
| Operating Instructions ..... | 9  |
| Practical Driving .....      | 20 |
| Winter Service .....         | 25 |
| Lubrication .....            | 28 |
| Wheels and Tires .....       | 37 |
| Care of the Car .....        | 39 |
| Maintenance .....            | 42 |
| General Description .....    | 59 |
| Technical Data .....         | 62 |
| Lubrication Chart .....      | 67 |
| Maintenance Chart .....      | 68 |
| Index .....                  | 69 |

VOLKSWAGENWERK GMBH WOLFSBURG  
Germany

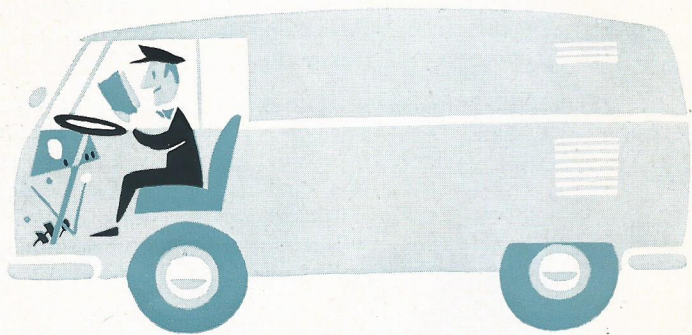

# DRIVER'S CONTROLS

Are you familiar with the controls and instruments of your new VW TRANSPORTER? Just take a seat behind the wheel, make yourself comfortable, and get acquainted first with all the various levers, switches, and controls. Some of the features are familiar to you already, but here are the full details.

## ONLY ONE KEY

is required to operate door and rear panel locks, switch on the ignition, and operate the starting motor (1). It is advisable to record the key number and keep it with the vehicle documents. In the event of having lost the key, you can easily obtain a new one from your dealer by referring to the number.

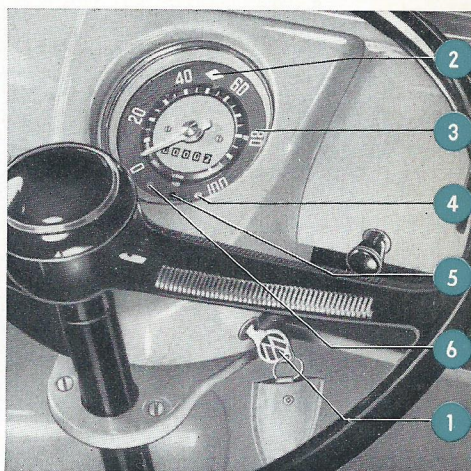
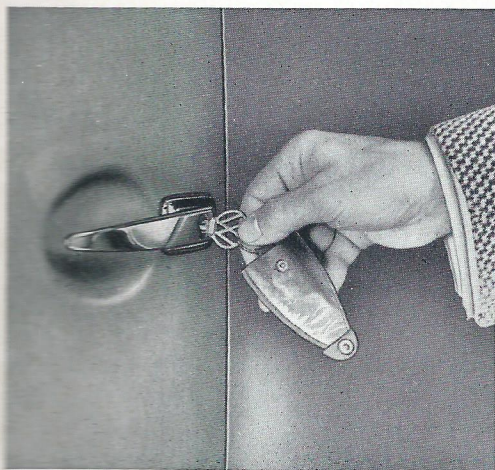

## INSTRUMENTS:

- 3 - Speedometer and odometer
- 5 - Warning light — Blue — Headlight upper beam
- 4 - Warning light — Green — Oil pressure
- 2 - Warning light — Red — Direction indicators (diamond)
- 6 - Warning light — Red — Generator and cooling system



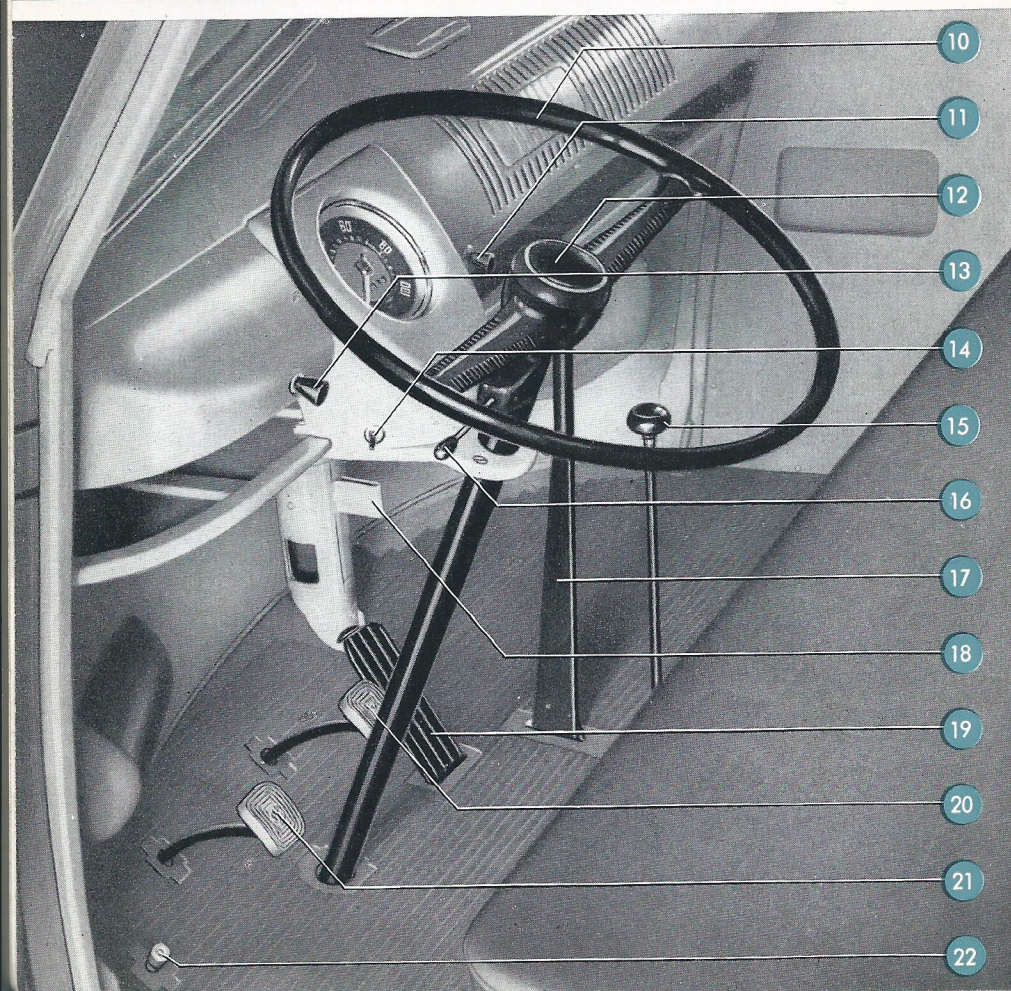
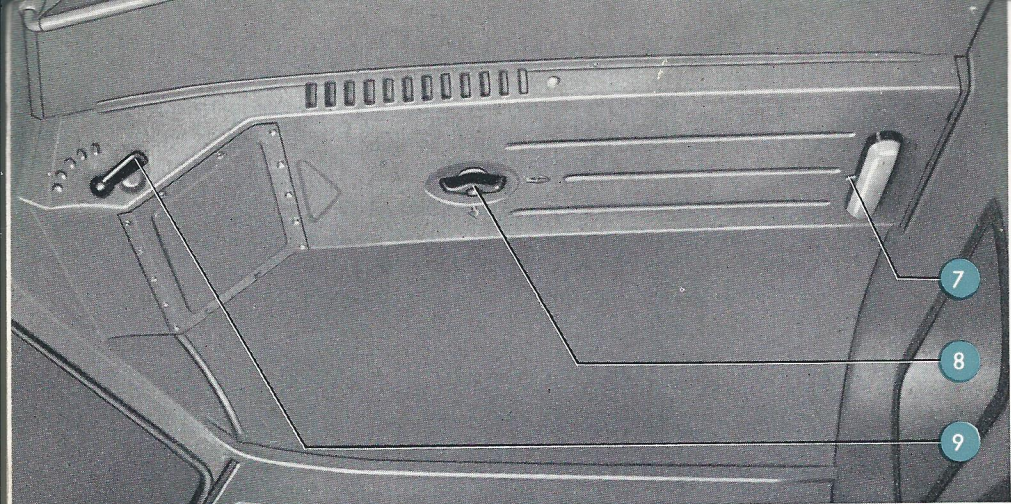



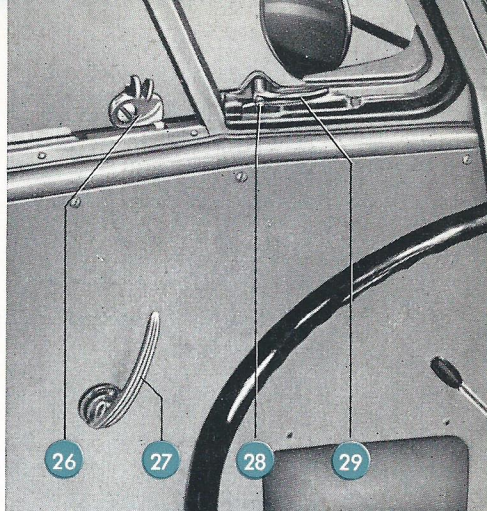
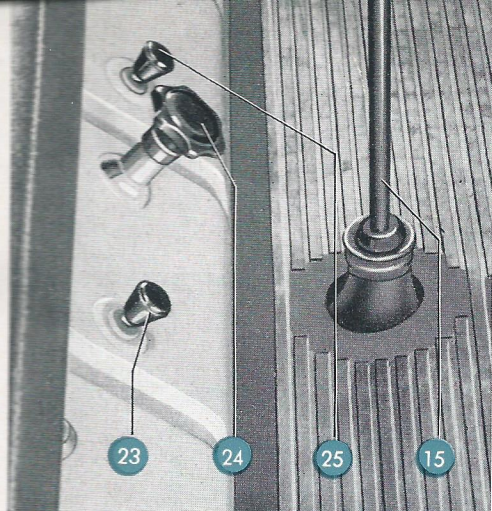

## HAND CONTROLS:

|  |    |  |    |
|--|----|--|----|
| Combined ignition and starting switch (page 5) ... | 1  | Operating lever for fresh air regulator .....  | 9  |
| Steering wheel .....                               | 10 | Fresh air deflector handle .....               | 8  |
| Gear lever .....                                   | 15 | Cab lamp switch .....                          | 7  |
| Hand brake lever .....                             | 17 | Heating control .....                          | 24 |
| Direction indicator lever .....                    | 16 | Choke control .....                            | 25 |
| Headlight and instrument light switch .....        | 11 | Fuel tap operating knob (push-pull type) ..... | 23 |
| Horn button .....                                  | 12 | Door inner handle .....                        | 27 |
| Heated air distributor .....                       | 18 | Vent wing lock .....                           | 29 |
| Tumbler switch for cargo room lamp                 | 14 | Vent wing lock release button ....             | 28 |
| Windshield wiper switch .....                      | 13 | Sliding glass panel catch .....                | 26 |

## FOOT CONTROLS:

|                    |    |                               |    |
|--------------------|----|-------------------------------|----|
| Clutch pedal ..... | 21 | Accelerator pedal .....       | 19 |
| Brake pedal .....  | 20 | Headlight dimmer switch ..... | 22 |



In the documents which come with your vehicle you will find, among other data, details regarding the model, year of construction, and chassis and engine numbers. The Police or Traffic Department will check if the information on the papers corresponds exactly with that on your vehicle.

**THE IDENTIFICATION PLATE**

is found on the vertical surface to the right of the engine.

**THE CHASSIS NUMBER**

is found to the right of the engine just below the identification plate.

**THE ENGINE NUMBER**

is stamped on the generator support.

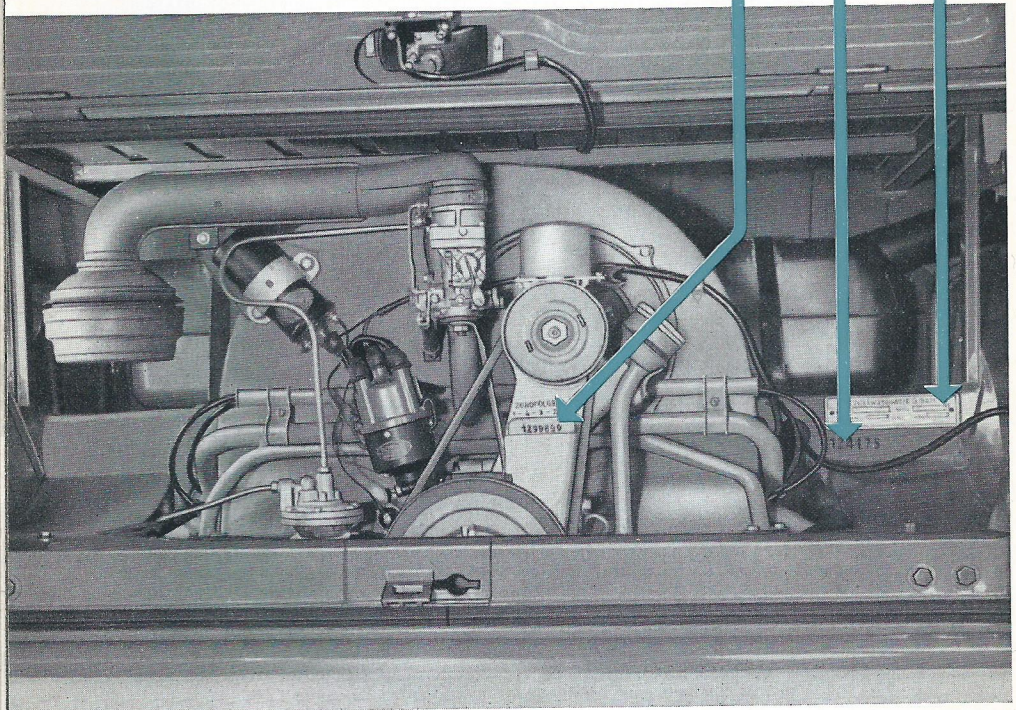



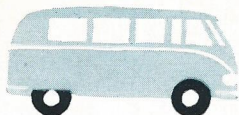

## OPERATING INSTRUCTIONS

### **BEFORE YOU DRIVE AWAY**

please check

- engine oil level
- fan belt tension
- quantity of fuel in the tank
- tire pressures
- efficiency of brakes

and, if driving at night,

- the exterior lights

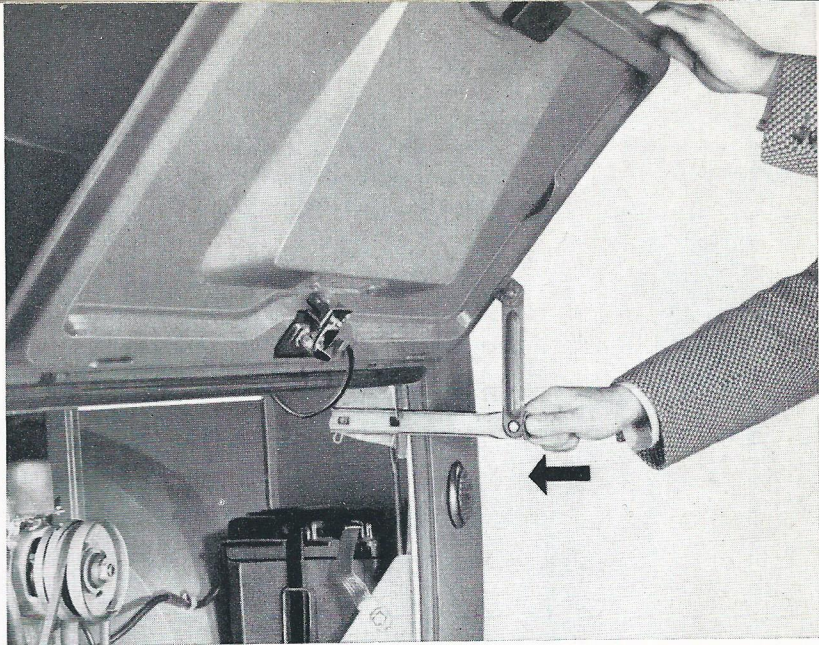

The engine compartment lid is opened by means of the square key delivered with the vehicle. The lid can be lowered by pressing against the horizontal bar of the check mechanism.

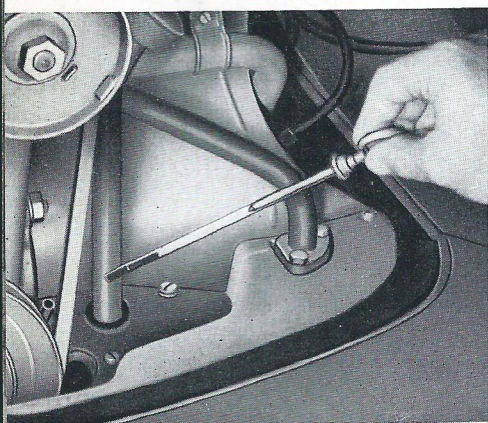

## ENGINE OIL LEVEL

The oil level should be checked with the engine at rest. The oil level is satisfactory when it is between the two marks on the oil level dipstick, but **it should never be permitted to drop below the lower mark.** To make an accurate check, it is best to wipe the dipstick with a clean rag before.

Should it become necessary to top up, please remember the following hints: Most oils marketed at present contain chemical ingredients to improve their lubricating qualities. However, oils of



different origin behave differently when used as engine lubricants and should, therefore, not be mixed.

**Select a HD oil from well-known and dependable brands right at the beginning, and stick to it!**

It would be wrong to fill in HD oil and Regular oil at random, or even to mix these two types!

## FAN BELT

The V-belt drives the generator and the fan. Perfect condition and correct tension of the belt insure its long life and adequate cooling of the engine. Checking is very simple: the belt, when slightly pressed with the finger, must yield approximately 2 cm. (nearly 1 in.). No traces of excess use, such as frayed edges, should be perceptible.

$a = 2 \text{ cm. (approx. 1" )}$

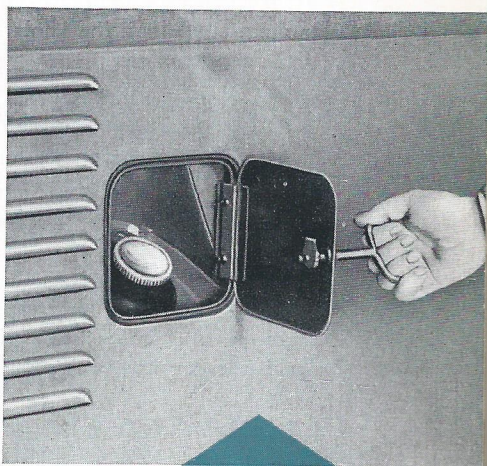
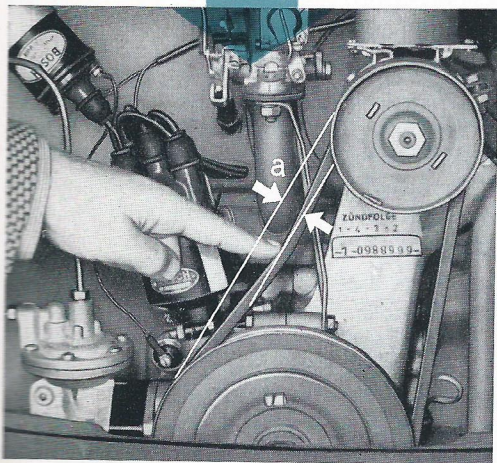

## FUEL TANK

The tank has a capacity of 40 liters (10.6 U.S. gals., 8.8 Imp. gals.), sufficient for a drive of approx. 420 kilometers (260 miles). The tank filler tube on the right-hand side of the vehicle is accessible by opening the cover with the square key delivered with the vehicle.





Positions of fuel tap:

- 1 - Open
- 2 - Reserve
- 3 - Closed

The fuel tap is operated by a push-pull knob from the driver's seat. Under normal conditions, the knob should be pushed fully home. The tap is then in the open position.

If the engine begins to "stutter" as a result of lack of fuel, just pull the knob fully out to switch the tap to "reserve". A fuel reserve of 5 liters (1.3 U.S. gals., 1.1 Imp. gals.) will then last for a further drive of about 50 kilometers (30 miles). It is important to push the knob fully home again when filling the tank, otherwise there will be danger of running out of fuel on the road. With the knob pulled out half its travel, the fuel tap is closed.

The design of the VW Engine allows an operation on all proven trade-mark fuels. Trade-mark fuels, including gasoline-benzol blends, comprise such characteristics as constant physical properties, sufficient anti-knock qualities and freedom from objectionable constituents.

**The selection of a grade and brand of fuel is therefore left entirely to your discretion.**

## THE TIRES

deserve and require your special attention. The riding comfort and the road-holding of your VW TRANSPORTER will greatly depend on their condition. Maintaining correct tire pressure and avoiding driving abuses are the most important factors in obtaining maximum tire life. Check regularly and keep tires inflated to the following pressures:

Front ..... 2.0 atm. (28 lbs. sq. in.)  
Rear and  
spare wheel .... 2.3 atm. (33 lbs. sq. in.)

Do not forget to replace the valve dust cap after this inspection.

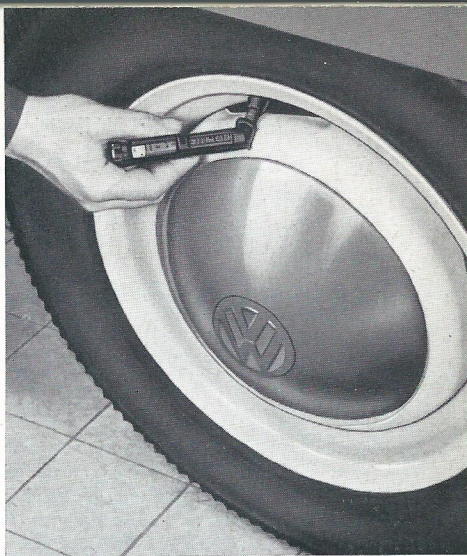

## THE BRAKES

should be checked before the car starts on a trip by gradually pressing down on the brake pedal while the car is in motion to ascertain proper functioning.

## GOOD EXTERIOR LIGHTS

are the first requirement of safe car operation at night. The three positions of the lighting switch are the following:

- 1 - Fully pushed in — Off.
- 2 - Pulled out to first stop — Parking light, tail and license plate lights.
- 3 - Fully pulled out — Headlight upper or lower beams (depending on position of foot dimmer switch), tail and license plate lights.

When pulling out the lighting switch knob either to the first or second stop, the instrument light is automatically turned on. By turning the knob, a variable degree of instrument lighting is obtained, turning the knob to extreme left turns off the light entirely. When checking the lighting system, do not forget the two stop lights which should light up when depressing the brake pedal with the ignition turned on.



## STARTING THE ENGINE

is easy, because you are now familiar with the various controls and instruments. However, make sure that the gear lever is in neutral position before starting the engine.

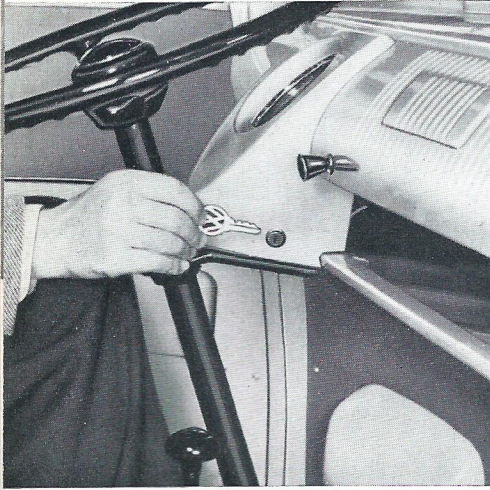

The ignition key starting enables you to start the engine by merely turning the ignition key. First the ignition is switched on by turning the key to the right. The red generator warning light and the green light for the oil pressure will light up. To start the engine, the key is pressed against a spring load and further turned clockwise until the starting motor operates. As soon as the engine fires, release pressure on key to disconnect starting motor.

**In cold weather, the transmission oil is apt to congeal. It is, therefore, good practice to declutch until the engine fires. Thus you will save the battery and facilitate the operation of the starting motor.**

**You will never encounter any difficulties when starting your engine in severe frost, if you observe the rule of using the specified thin engine oil.**

To start the engine **when cold**, pull out the choke control knob and let the starting motor operate until the engine fires. Do not depress the accelerator pedal. As soon as the engine starts, slowly push in choke control knob (about half its travel) until the engine runs smoothly and evenly at fast idle speed without a tendency to stall.

This position of the choke control knob permits a quick moving off without any detriment to the engine. Neither will harm be done to the engine when you drive for a longer period in dense city traffic with the choke pulled out half its travel.

**As the engine attains operating temperature, you will notice an increase in the idling speed. At the same time gradually push the choke control knob fully home.**

This position must be reached before you make use of the full engine power on a free road. If the engine does not start within ten seconds, just repeat the



procedure a few times, allowing a short interval between each successive attempt, as the battery is being strained heavily by continuous starting motor operation.

To start the engine **when hot**, do not pull the choke control knob. **Slowly** depress accelerator pedal while operating the starting motor. Do not pump the accelerator pedal. **It is important to know that pumping the accelerator pedal makes a starting of the warm engine difficult and increases the fuel consumption.**

## CAUTION!

**Be careful when starting the engine inside your garage. See to it that the door and windows are open so that the exhaust fumes can escape. They contain the colorless, tasteless and odorless, yet extremely poisonous carbon monoxide gas.**

## DRIVING AWAY

is extremely easy, if you observe the following:

- 1 - Press down the clutch pedal as far as possible. Keep it in that position.
- 2 - Shift to the first gear. Release the hand brake.
- 3 - Engage the clutch by gently removing your foot from the pedal, while simultaneously pressing down the accelerator pedal. The car rolls!
- 4 - Gradually increase the pressure on the accelerator pedal and remove your foot completely from the clutch pedal, as the clutch is now fully engaged.

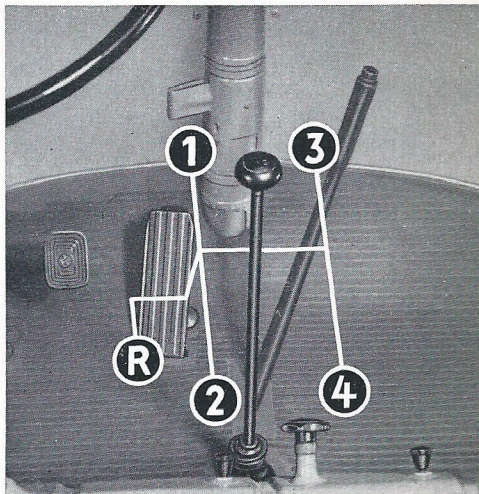

Shifting to second gear is equally simple:

- 1 - Take your foot off the accelerator pedal, while simultaneously pressing down the clutch pedal.**
- 2 - Shift gear lever into second position.**
- 3 - Engage the clutch by taking your foot off the pedal gently and gradually and again step on the accelerator pedal.**

You now know how to "shift gears", and may at will shift to third and fourth positions. You will have noticed by now that the accelerator and clutch pedals are operated simultaneously, but in opposite directions. It is the coordination of these simultaneous operations that brings skill in shifting gears. To engage the **reverse gear**, first press down the gear lever vertically, move it to the left and pull it rearwards.

### **SHIFTING TO LOWER GEAR**

This is what you should do in close city traffic, or with sharp turns ahead of you, or when driving up-hill.

- 1 - Release accelerator pedal and depress clutch pedal.**
- 2 - Shift to 3<sup>rd</sup> or 2<sup>nd</sup> gear respectively.**
- 3 - Release clutch pedal and step on accelerator pedal simultaneously.**

Of course, this goes much more quickly in actual operation than by describing it here. We do not want to bore you with a technical discourse, but it may be of interest to you to know that, when changing down, the synchromesh device assures meshing of the gears without clash, as the lower gear is brought into synchronism so that both gears are turning at the same speed.

When shifting gears, it is absolutely necessary to fully depress the clutch pedal. Incomplete declutching makes gear shifting difficult and leads to rapid wear of the synchronizer stop rings.

The first gear is not provided with a synchronizing device, as the main drive shaft normally is not turning when the car is shifted into first.

**Should it become necessary to shift from second to first**, the two cogwheels of the lower gear should be brought to the same ratio of speed by momentarily depressing the gas pedal with the shift lever in neutral position to insure an easy and silent engaging of the gears.

After a short period of practice, you will take pleasure in the correct handling and shifting of the gears and obtain the utmost satisfaction from the efficient performance of your new VW TRANSPORTER. Under no circumstances should you be afraid to shift to lower gear, or even try to avoid shifting occasionally by merely letting the clutch "slip" in a partly disengaged position.

**Moreover, the clutch pedal should never be used as a foot-rest while driving your vehicle!**



## BRAKES

The brakes should be applied sparingly. The inexperienced driver can be recognized by the too frequent lighting-up of the stop light. By removing your foot from the accelerator pedal, the engine compression will serve as a brake, thus saving fuel and preventing premature wearing of tires and brakes. Don't drive too fast and then skid to a stop, but drive at a moderate speed, commensurate with the traffic, and your car will perform most economically. To press down the brakes suddenly can only be justified when danger is ahead.

Operate your brakes especially gently when the road is wet or covered with ice. Sudden braking of the wheels will result in skidding of the car.

Here is one of the fundamental rules:

USE YOUR BRAKES **BEFORE**, NOT **WHILE** MAKING A TURN!

When driving **down-hill**, make use of the braking capacity of the engine compression by shifting to that gear which you would use in driving up-hill. You will save and preserve the brakes if you use them only to control the speed occasionally, and at the same time you will attain a higher degree of safety. The ignition must never be switched off when descending grades.

## STOPPING THE CAR

Take your foot off the accelerator pedal and operate the brakes gently. Shortly before the car comes to a full stop, release the clutch and place the gear lever in neutral position. The engine continues to idle.

If you wish to turn off the engine, merely switch the ignition key to the left.



## THE INTERIOR LIGHT

of the cab is operated by a switch built-in with the lamp.

The light in the cargo room or passenger compartment is operated by the tumbler switch situated on the left-hand side of the instrument panel.



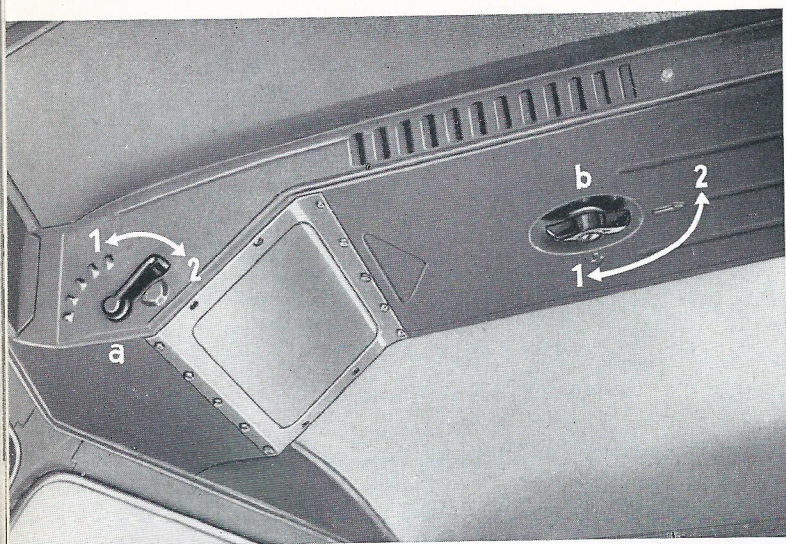

### THE FRESH AIR REGULATOR

above the windshield offers an efficient ventilation of both cab and cargo room or passenger compartment. The ventilation is turned on at the lever located at the left-hand side of the air guide channel. The air intake can be regulated by turning the lever to one of its five positions. With the lever in the rearmost position, the air intake is fully closed. The distribution of the fresh air is done by deflector plates which are moved by a handle at the bottom of the air guide channel.

Handle in transverse position: Cab is ventilated.

Handle in driving direction: Cargo room or passenger compartment is ventilated.

Handle in oblique position: Both cab and cargo room or passenger compartment are ventilated.

a - Fresh air regulator lever

b - Fresh air distribution

1 - On

1 - Cab

2 - Off

2 - Cargo room or passenger compartment

### THE SUN ROOF

is free to slide by placing the locking lever to the left. It may be fixed in any desired position by merely moving the lever to the right. It is good practice,

however, to fully open the roof prior to sliding it to the desired position. This will not only make the opened roof look better, but will also save the material by a proper folding.



### THE ASH RECEIVER

in the instrument panel can be easily removed by pushing it upward from below the panel.

The ash receivers in the passenger compartment of the VW Micro Bus are pulled up for removal.

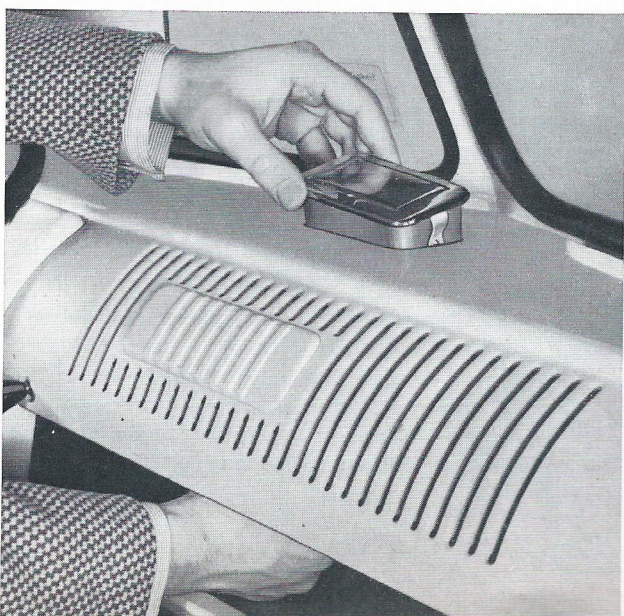



# PRACTICAL DRIVING

## BREAKING-IN (RUNNING-IN) PERIOD

does not imply inconvenience as restrictions are not imposed on the speeds in the various gears.

Progressive refinements have raised the VW engine to its present predominant position and it is these refinements which allow an omission of breaking-in instructions. Your car may be operated right from the beginning at the full speeds recommended for the gears.

|                      |         |                              |
|----------------------|---------|------------------------------|
| 1 <sup>st</sup> gear | 0       | — 16 km. p. h. (10 m. p. h.) |
| 2 <sup>nd</sup> gear | 10 (6)  | — 32 km. p. h. (20 m. p. h.) |
| 3 <sup>rd</sup> gear | 20 (12) | — 52 km. p. h. (32 m. p. h.) |
| Top gear             | 30 (19) | — 80 km. p. h. (50 m. p. h.) |

## THE LIFE OF YOUR CAR, ITS PERFORMANCE, AND ITS OPERATION WILL DEPEND ON YOUR DRIVING HABIT

Maximum satisfaction in the running of your car will be assured by following the fundamental rules for driving an automobile:

— **Do not unnecessarily race the engine no matter whether the car is stationary or in motion.**

The new engine is not governed. Therefore, it is good practice to glance at the speedometer hand from time to time. The maximum permissible speeds in the gears are marked red on the speedometer dial.

— **Do not allow the engine to labor by driving at too low speeds.**

Don't believe that your engine will be saved and preserved most when it is operated at low speeds only. You won't reduce the fuel consumption either. The engine requires air for cooling, which is only attained at an adequate number of revolutions. It is overloading and overheating that are harmful to the engine, but never high speed operation.

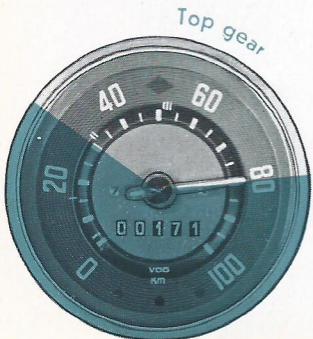
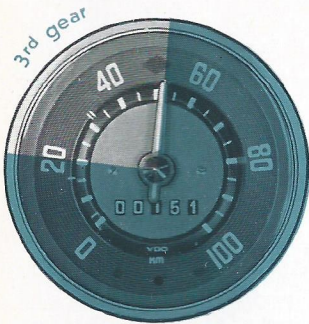
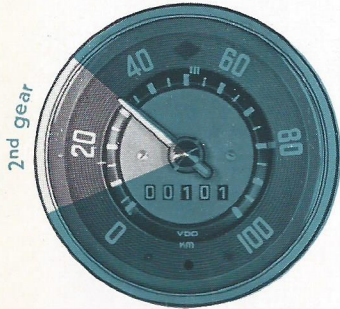
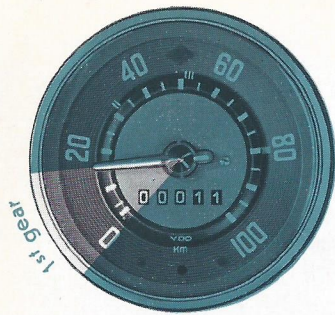

### **— When driving up-hill**

always change gear as soon as the speed drops and the speedometer hand approaches the maximum speed limit of the next lower gear. Never allow the engine to labor in 4<sup>th</sup> gear, which is nearly an overdrive, and expect it to pick up speed on feeding more gas.

## **ECONOMICAL OPERATION**

is one of the outstanding features of your car. However, whether or not a few extra miles will be yielded from each gallon will depend on the manner in which you handle the car and shift gears.

### **— When accelerating,**

step on the accelerator pedal slowly and only to such an extent as is necessary for reaching the desired speed. Depressing the accelerating pedal rapidly does not improve acceleration, but results in an increased fuel consumption.

### **— Do not "pump" the gas pedal**

unless circumstances require it. Even the small quantity of fuel additionally discharged by the accelerator pump each time the accelerator pedal is depressed results in a marked increase in the overall fuel consumption.

### **— Operate your car smoothly and flexibly**

both when driving in city traffic and on main roads. Adapt the speed of the car to prevailing road and traffic conditions. A good driver accelerates the car moderately, slows down in time, and utilizes the braking power of the engine. Make use of the full acceleration capacity and the excellent brakes of your car only when circumstances require it.

## **HOW TO DRIVE AT HIGH SPEED WITHOUT SACRIFICING FUEL ECONOMY**

When you have accelerated the car to the desired speed, slowly let the accelerator pedal return to the position which just maintains this speed. This practice is especially economical when driving on highways. If you attach particular importance not only to the economy of your car, but also to a fair average speed, it would prove of value to make a compromise in the choice of the cruising speed in the interest of fuel economy.

The most economical speed is between 45 and 65 km. p. h. (28 and 40 m. p. h.). The fuel consumption does not go up equally with the speed; it increases more rapidly at higher speeds. Perhaps you are aware of the fact that air resistance is an obstacle for all high-speed vehicles. Due to the simple and sweeping lines of your VW TRANSPORTER, the air resistance is relatively low, but it should be remembered that high road speed always involves a greater fuel consumption.



## WATCH THE ROAD

closely while driving. As to the various manipulations of levers, switches and controls, you by now are able to operate them automatically. Furthermore, your TRANSPORTER on its own accord will "tell" you when it needs attention.

### DIRECTION INDICATORS

**Red Diamond**

The direction indicators lie outside the driver's view. However, the red indicator lamp will serve as a reminder in case you have forgotten to turn the signals off.

The direction indicator switch can be operated without taking the hand off the steering wheel.

### GENERATOR AND COOLING

**Red Light**

are controlled simultaneously by a red light. The light will show when the ignition is turned on and when the engine is running at low speed. The light should go out as speed is increased.

**CAUTION!** If the lamp lights up while you are driving the car, the fan belt may be broken. Bring your vehicle to a stop and find out what is wrong, for when the belt is broken, the cooling is disrupted and the generator no longer charges.

### OIL PRESSURE

**Green Light**

The oil pressure of your car is as important as the oil level, which you have already checked. When the ignition is turned on, the Green Oil Pressure Lamp will light up. The light should go out when the engine is started and the oil pressure increases.

**CAUTION!** Should the light stay on during the ride, the chances are that the oil circulation has been interrupted, which means that the lubrication of the engine has ceased. Stop at once and check the level of the oil before you consult a Service Station. An occasional flashing up of the lamp with the engine warm and at low speed does not indicate trouble, if it goes out again as the speed increases.

### HEADLIGHTS

**Blue Light**

The upper beam of your headlights throws glare into the eyes of oncoming drivers. You know yourself how unpleasant and dangerous this is. For this reason, be considerate! The blue light will tell you when the upper beam is switched on. Just step on the dimmer switch to transfer the headlights from upper to lower beams and vice versa.

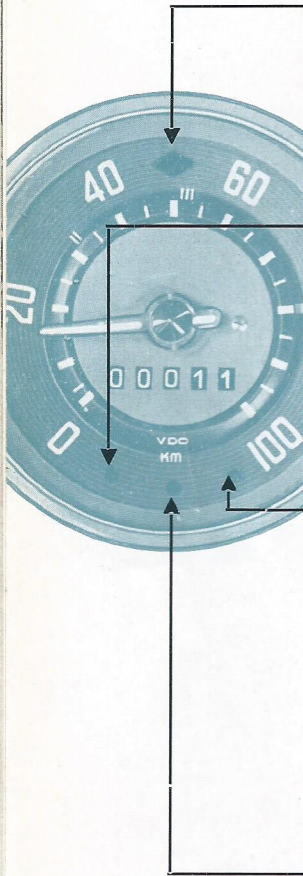

## **SPEED**

The speed of your VW TRANSPORTER is liable to be underrated due to its perfect driving comfort. Special attention should be paid, therefore, to the speedometer during the initial driving period.

## **SAFETY FIRST**

Safety for yourself, and safety for others, this is what counts most! Your VW TRANSPORTER is a car that "hugs" the road in an excellent way, and does not sway when taking a turn. Your car has an extraordinary capacity for acceleration. Yet, the feeling of security and safety which you will acquire after a few miles should not tempt you to become careless.

Therefore, adjust the speed of your car to the conditions of road, traffic and weather, and always be ready to bring your car to a stop when it is necessary. Be particularly careful when driving on wet or icy roads, for even a VW TRANSPORTER is apt to skid when not driven carefully under such conditions.

## **PASSING OTHER CARS**

Pass other vehicles with consideration. Always be sure that the road is clear ahead of you, and look out for cars approaching you from the opposite direction. A brief look in your rear view mirror will tell you whether another car is about to pass you from behind. If you have to shift to a lower gear, do it before, not while, passing other cars.

And here is another warning: Never try to pass a car when approaching a curve, where vision is not clear, and never pass a vehicle at the crest of a hill, or at crossroads! You never can tell what lies ahead of you!

Be fair and do not step on the accelerator when another car tries to pass you. You will endanger your life and others!

## **STOPPING YOUR CAR TEMPORARILY**

**When stopping your car in front of a traffic light or railroad crossing, do not wait for free passage with the clutch pedal pressed down and the gear lever in position. Shift to first gear shortly before moving on again, it will preserve the clutch!**

## **PARKING YOUR CAR**

in a space between two other cars that are parked at the curb will be fun for you if you heed the following advice:



Stop your car even with the car in front of the space. Turn the steering wheel sharply to the right and back your car slowly into the gap.



When the front bumper of your car is even with the rear bumper of the car ahead of you, turn the steering wheel fully to the left, and back up further toward the curb.

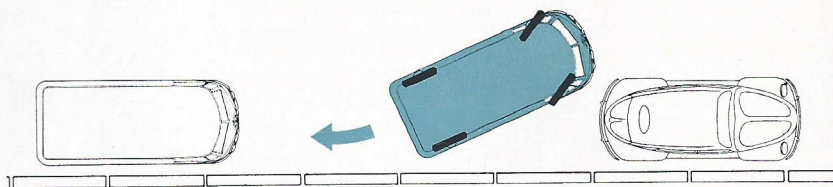

Now turn the steering wheel again to the right and pull up a little bit, until both ends of the car come as close to the curb as possible.

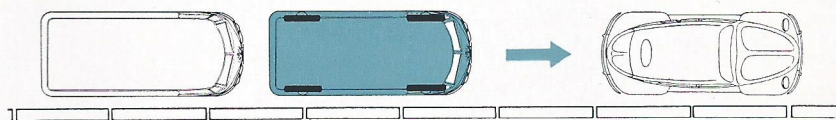

When parking on a steep grade, set the handbrake so as to keep the car from rolling. As a precautionary measure, it is advisable to engage first or reverse gear in addition to the handbrake. And do not forget to take the key out of the ignition lock before you leave your car!

Prior to locking the left-hand door secure the right door by lowering the inside door handle.

Do not forget to shut the fuel tap and to lock the door windows when leaving the car stationary for a longer period.



## WINTER SERVICE

### IN WINTER

there are two advantageous features of your VW TRANSPORTER that you will appreciate most:

### AIR COOLING AND HEATING

You may expose your car to bitter cold without fear: — its air-cooled engine will always be ready to start! You will drive in warm comfort, well protected from drafts and from sleet and snow, while a current of warm air will keep your windshield free from condensation and frost, permitting you a clear view.

The increased stress that your car has to stand in winter because of frost and dampness can be easily dealt with if you observe the following:



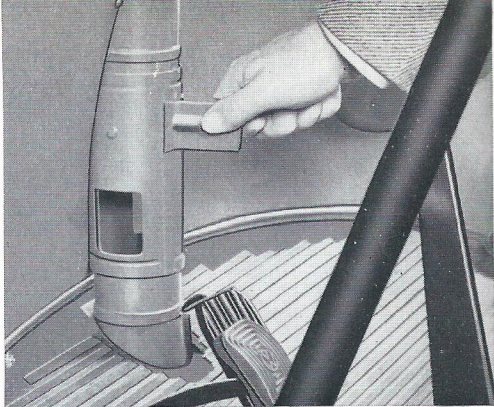
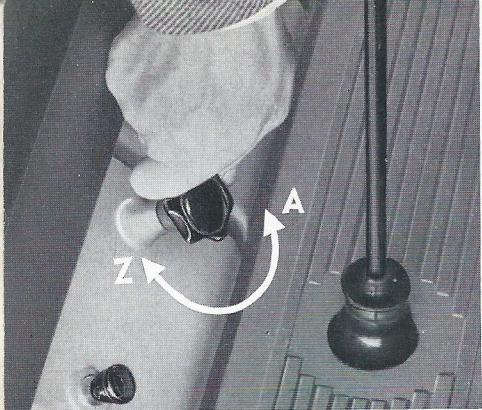

## THE WARM AIR HEATING

can be regulated by a rotary knob situated under the seat:

- Anti-clockwise — On (A)
- Clockwise — Off (Z)

The warm air distributor in front of the hand brake lever provides an additional control.

## ENGINE OIL

SAE 20/20 W oil will not congeal in cold weather down to  $-15^{\circ}\text{C}$  ( $+5^{\circ}\text{F}$ ) and will permit easy starting of the engine. If, however, temperatures are expected to fall below  $-15^{\circ}\text{C}$  ( $+5^{\circ}\text{F}$ ), it is recommended to change to SAE 10 W oil at the next regular engine oil change. This grade oil may remain in the engine with safety when the temperature again rises to a higher range. Should it become necessary to add oil in the period between two regular oil changes, SAE 10 W oil may be used at lasting frost and SAE 20 oil when the temperature average rises. This means that the grades SAE 10 W and SAE 20/20 W can be mixed without involving any disadvantages, but be sure to use always the same brand and type of engine oil.

In cold weather, allow the engine to idle for half a minute before driving to insure correct oil circulation.

### **Don't race the engine in severe frost to obtain a quick start.**

Only if your VW Transporter is mainly operated for short distances **during cold weather** it is recommended to have the oil changed at more frequent intervals, say every 2000 km. (1250 miles), using HD oil (for Service MS). In the warmer season, oil changes in addition to those laid down in the Lubrication Chart are unnecessary and uneconomical.

## TRANSMISSION OIL

serves its purpose in any season and needs, for this reason, no particular attention or change.

## THE CHASSIS

is particularly exposed to the cold and wet weather in winter. For this reason it will be necessary, and only logical, to adhere strictly to our instructions for lubrication. If, in addition, you will spray the bottom of the car with a special chassis oil, as a protection against rusting, you will have prolonged the life of your car. The shifting rod should be well greased at the points where it passes through the crossmembers.

## THE BRAKES

of all automobiles are exposed more or less to splashing water that in winter is apt to freeze in the brake drums. Therefore, when parking your car, do not set the hand brake, but shift to the first or to the reverse gear instead — for safety's sake!

At the beginning of the cold season, the conduit tubes of the brake cables should be thoroughly lubricated with anti-freeze lubrication grease. Do not use just any car-lubricant, but get the right one at any VW Service Station.

## TIRES

Worn off tires are apt to cause trouble in winter. To assure a safe operation, replace them in time. To meet the special requirements in winter, so-called **M + S** tires are available. These special-tread tires are designed to give a better grip on **mud** and **snow**. They are either used on the rear wheels only or on all four wheels. However, during the rest of the year you should rather use the usual tires.

## NON-SKID CHAINS

You will need non-skid chains only when the roads are covered with snow. Without such chains, the rear wheels of your car are apt to spin, and applying the brakes may result in the car skidding. Have the non-skid chains adjusted to the wheels, if you wish to avoid loss of time and inconveniences later on! When driving on long stretches that are free from snow, the chains should be removed to prevent excessive wear of both chains and tires.

## THE BATTERY

has to meet higher requirements in winter than in warmer seasons due to the increased consumption of current when starting the engine and using the lights at night. Besides this it is a characteristic feature of any battery that its efficiency decreases at lower temperature.

Therefore, have your battery checked regularly, and you will never have starting difficulties.





## LUBRICATION

### **PROPER LUBRICATION IS OF VITAL IMPORTANCE TO YOUR VW TRANSPORTER**

The extra time spent in following these recommendations will be amply rewarded in the long run by your car's efficient performance. It is up to you to maintain the standard of safety offered by your VW TRANSPORTER, and to insure the long life and good service which you have the right to expect from this highly economical car!

### **TO LUBRICATE CORRECTLY MEANS TO LUBRICATE AMPLY AND AT PRESCRIBED INTERVALS!**

Therefore, do not shy at the work connected with the regular lubrication service. A Lubrication Chart can be found on page 67, indicating the respective mileages at which to lubricate.

### **ENGINE OIL CHANGE**

The change of oil at prescribed intervals is necessary even if the very best trademark oils are used. Diluted and dirty oil in your engine simply means a greater strain and a shorter period of life for your engine. On the other hand, provided

**Oil Strainer**  
with cover

**Oil Drain Plug**  
for crankcase

**Oil Drain Plugs**  
for rear axle and  
transmission

**Oil Drain Plug**  
for reduction gears  
at rear wheels

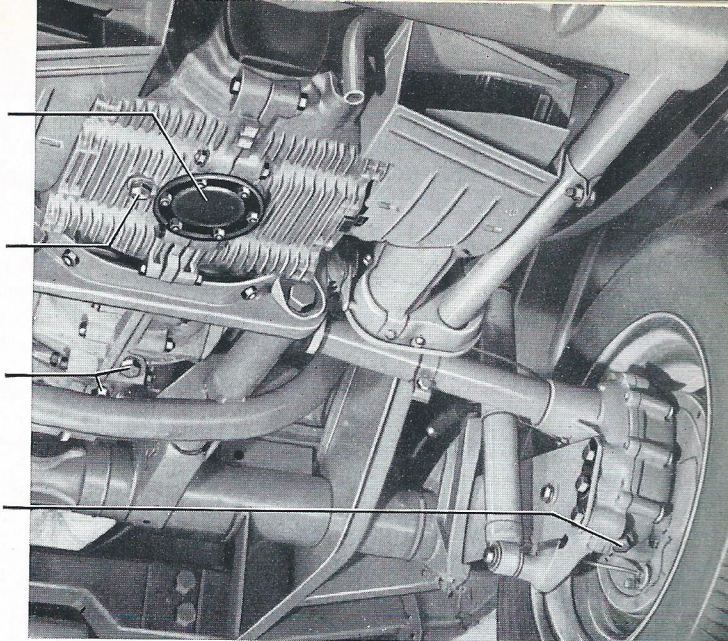

that HD oil is used, it is unnecessary and uneconomical to change the oil more frequently than called for in the Lubrication Chart.

The oil is drained by removing the plug at the bottom of the crankcase. To insure complete draining, it is important that the operation be performed while the engine is warm.

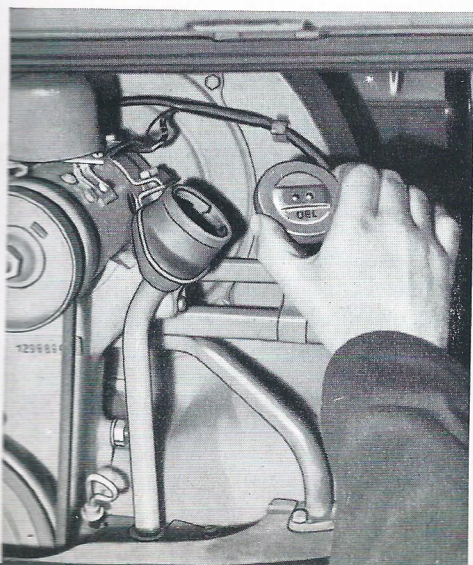

The engine is refilled with

**2 $\frac{1}{2}$  liters of HD oil**  
(5.3 U.S. pints,  
4.4 Imp. pints)

The constant use of HD oil renders a flushing of the engine unnecessary.

If, however, being compelled to use a regular engine oil not having the detergent-dispersant characteristics of HD oil, the oil should be changed at



intervals of 2000 km. (1250 miles). The engine should be allowed to idle while being flushed thoroughly with one liter (1 quart) of the same type of oil which you use afterwards for filling. This assures a better cleaning of the complete lubrication system.

Under no circumstances a so-called flushing oil, or even kerosene, should be used for flushing the engine. The residue of the flushing agent, which would remain in the crankcase and especially in the oil cooler, is liable to decrease the lubricating efficiency of the fresh oil.

Never allow a haphazard changing from HD oil to Regular oil and vice versa.

## THE OIL STRAINER

retains foreign matter and should be taken out and cleaned as called for in the Lubrication Chart. When the strainer is inserted again, the lower side should lie beneath the bend of the oil intake pipe. The two gaskets should be renewed each time the strainer is removed.

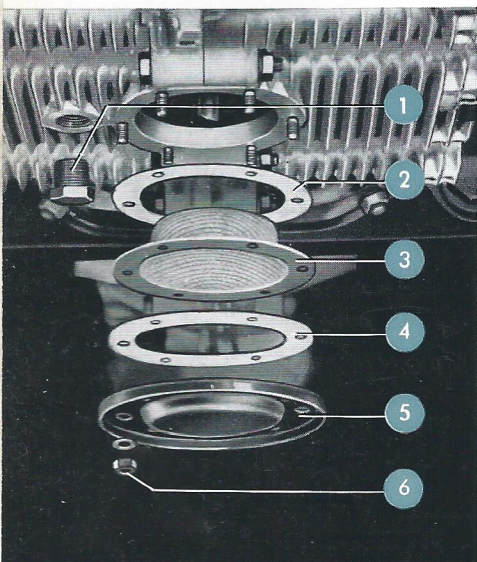
- 
- 1 - Drain plug
  - 2 - Gasket
  - 3 - Oil strainer
  - 4 - Gasket
  - 5 - Bottom plate
  - 6 - Nut and lock washer

## TYPES OF LUBRICANT AND RECOMMENDED USAGE

The advantages of using a

**trade-mark HD oil (for Service MS)**

are quite evident.

Regular oils, i. e., non-additive oils, do not combat the formation of sludge and deposits and the wear-increasing bearing corrosion when the car is operated for short distances and during cold weather. HD oil is an oil having proved oxidation stability, bearing corrosion preventive properties and detergent-dispersant characteristics which tend to hold in suspension foreign contaminants which would normally deposit on engine parts. These foreign contaminants will

drain out with the oil at the periodical oil changes. The detergent properties of HD oil will make the fresh oil darker already after a short time of operation. This is quite natural and there is no reason whatsoever to change the oil earlier than called for in the Lubrication Chart.

Upper lubricants and other agents, as colloidal graphite, etc., should never be added to HD oil.

## CHANGING FROM ONE TYPE OF OIL TO ANOTHER

If possible, HD type oils should be used for all new VW engines right from the beginning. If, for any reason, the engine has operated with Regular engine oil for a longer period, the following should be heeded when changing to HD oil:

- If engine has operated less than 10 000 km.  
(6 000 miles)

no precautions are necessary when changing to HD oil.

- If engine has operated more than 10 000 km.  
(6 000 miles)

or if you are not quite sure what type of oil had been filled into the engine at earlier oil changes, precautions must be taken to thoroughly clean the engine. The VW Service personnel is fully conversant with this job and will be glad to advise you.

## SOME MORE INFORMATION ON ENGINE OILS

It is left to your discretion to select an oil from well-known and dependable brands, being of the proper viscosity to suit your seasonal and driving requirements. In cases of doubt, refer to your authorized VW Dealer who will be glad to help you with your lubrication problems. It is recommended that you select "your" oil right at the beginning and stick to it at all future service oil changes. Viscosity of the lubricant is an indication of its resistance to flow at a given temperature. The SAE numbers classify lubricants in terms of viscosity, but with no reference to other characteristics or properties.

**SAE 30** This oil is satisfactory in tropical climates where the temperature range will frequently rise above 30° C (86° F).

**SAE 20/20 W** This grade oil should be used within the wide temperature range between +30° C and -15° C (+86° F and +5° F). If temperatures temporarily exceed these limits, there is no need to change to another grade.



**SAE 10 W** Engine oil of this viscosity should be used for all types of vehicle operation where the temperature will fall below  $-15^{\circ}\text{C}$  ( $+5^{\circ}\text{F}$ ). However, it should already be filled in when temperatures are expected to fall below  $-15^{\circ}\text{C}$  ( $+5^{\circ}\text{F}$ ) before the next regular oil change is due. Oil of this viscosity may also be used in the warmer temperature range with safety.

**SAE 5 W** This extremely light oil is for use in arctic climates only.

Apart from the oils mentioned above there are so-called multi-grade oils. These oils cover the range of several SAE grades, for example, SAE 10 W, 20 and 30. Thus, an SAE 10W/20 engine oil can be used both in severe cold and in summer.

In some countries API Classification is applied (API = American Petroleum Institute). According to this classification, the oils suitable for the VW engine are referred to as "For Service MS".

### **IGNITION DISTRIBUTOR**

The amount of grease at the breaker arm fiber block should be checked and, if necessary, replenished at the specified intervals.

Every 24 000 km. (15 000 miles), apply 4 or 5 drops of oil to the felt in the cam bearing after the rotor is taken off.

### **TRANSMISSION AND DIFFERENTIAL**

The transmission gears and the differential of your VW TRANSPORTER are combined in the transmission case and are lubricated jointly with gear oil. The used oil should be drained by simultaneously removing the two drain plugs, and such draining, too, should be done while the oil is still warm.

Then refill with **2 liters transmission oil (4.2 U. S. pints, 3.5 Imp. pints)**.

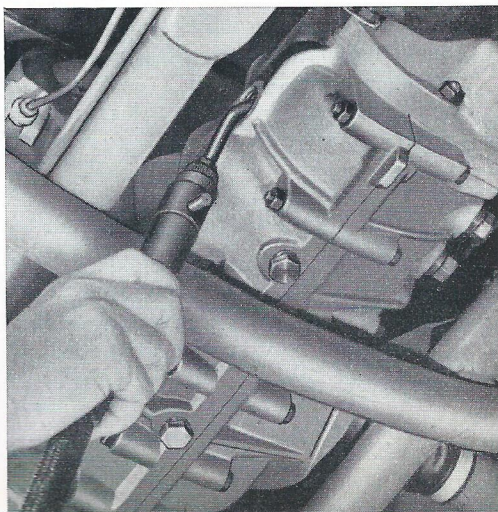
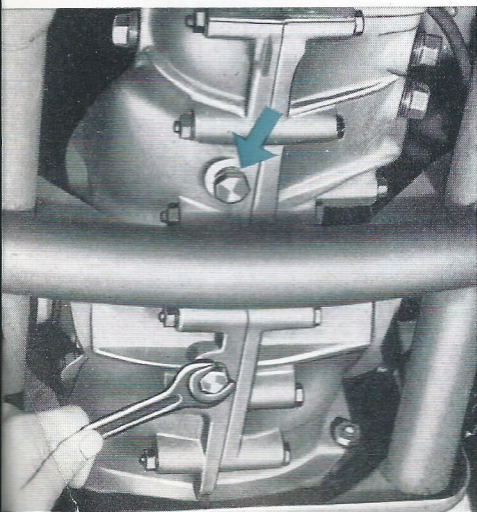



The oil level should be checked in accordance with the Lubrication Chart. Keep the lubricant level somewhat below the edge of the filler hole.

In order to maintain the characteristics of the gear oil, it should not be mixed with any other oil, as the two will not blend.

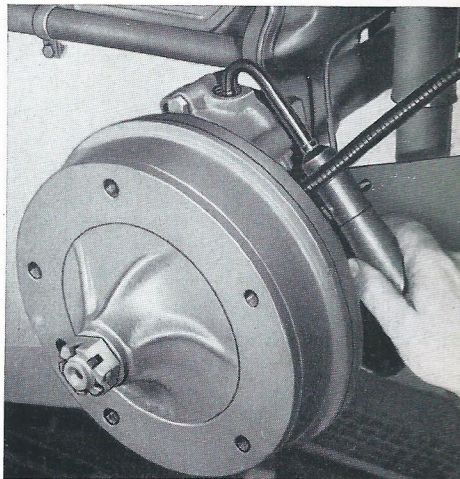
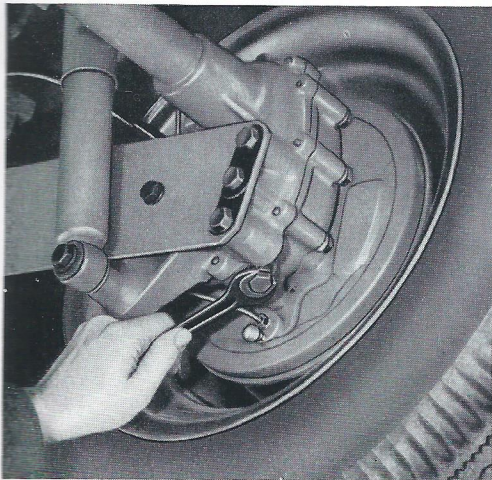

### REAR WHEEL REDUCTION GEAR

Each rear wheel reduction gear case should be refilled with  
**0.25 liter transmission oil (0.5 U.S. pint, 0.4 Imp. pint)**  
at the same intervals as the transmission case.

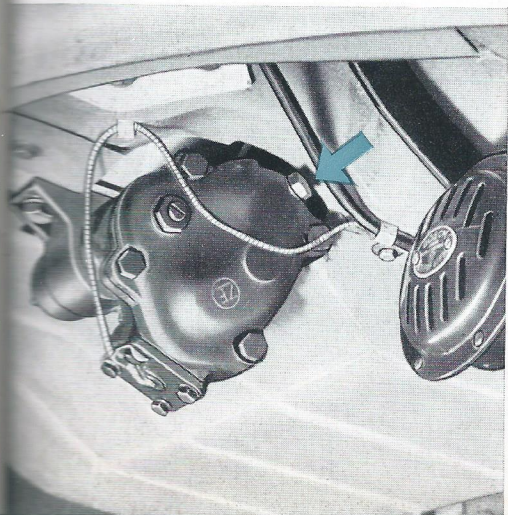

### STEERING GEAR

The steering assembly should be lubricated with transmission oil exclusively, and under no circumstances with grease or hypoid oil. The level of the oil in the steering case should be kept at the lower edge of the filler plug hole.



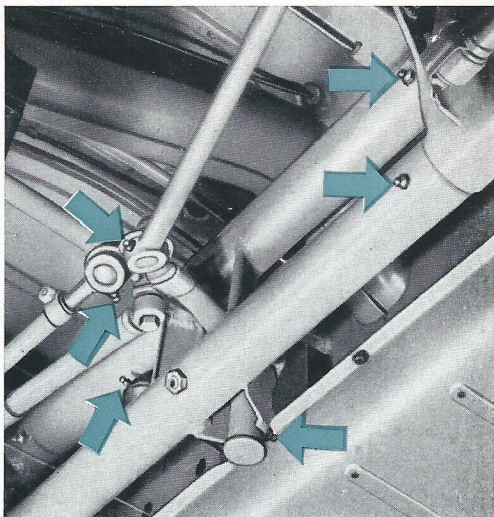
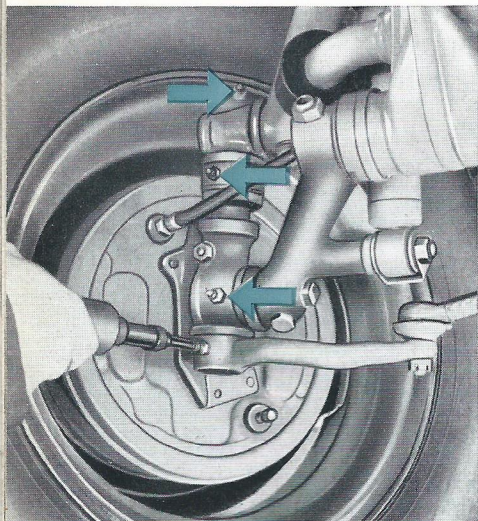

## CHASSIS

**A thorough lubrication of the front axle bearing points is only insured by raising the front axle so that the weight is taken off the wheels.**

Prior to lubrication, the grease nipples should be cleaned thoroughly with a clean piece of cloth, so as to avoid any dirt or foreign matter entering the nipples. The tip of the grease gun should be pressed into the nipple, whereupon grease should be injected until the excess grease begins to emerge at the edges of the lubrication point.

The number and the location of the lubrication points of the chassis can be gathered from the lubrication chart and the corresponding illustration.



If the vehicle is driven mainly over rough roads, it is recommended to lubricate king pins and outer tie rod ends at more frequent intervals, say every 1000 km. (600 miles).

Annually, at the beginning of the cold season, the cables and conduit tubes of clutch, accelerator and heating should be cleaned and greased.

## THE FRONT WHEEL BEARINGS

are sufficiently provided with grease already at the factory. The caps on the front wheel hubs must be free from grease.

According to the Lubrication Chart, the front wheel bearings are to be cleaned and repacked with 115 gr. (4 oz.) of grease for one wheel. First fill the ball bearings and use the remaining grease for the brake drum hub. Finally, the front wheel bearings must be adjusted. This operation should, if possible, be carried out at a VW Service Shop.

## GEAR LEVER

The gear lever can only be lubricated when removed. To do this, remove the two screws that attach the lever dome to the floor plate and lift off lever, dome and spring as a unit.

The contact surfaces in lever dome, at stop plate and lever ball socket should be amply provided with universal grease. When installing stop plate, make sure that the turned-up edge is on the righthand side.

After installation, make sure the gears engage properly. If necessary, correct position of gear lever.

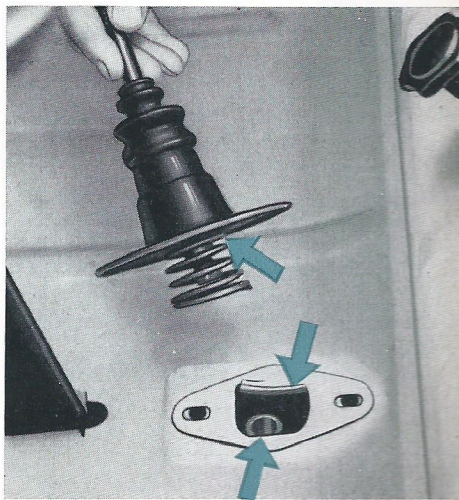



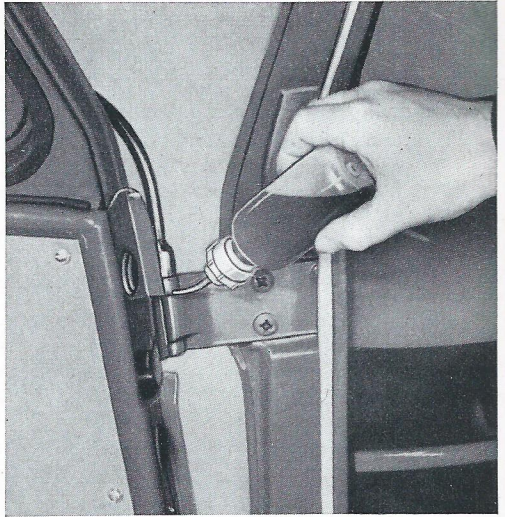

## DOORS AND LOCKS

The door latches and striker plates should be slightly greased. Apply a few drops of oil to the door and lid hinges, after dust and soil have been removed. Door cylinder locks should be treated with graphite. Blow a small quantity of powdered graphite through the key hole. Dip the key into the graphite, insert key and move it back and forth several times.

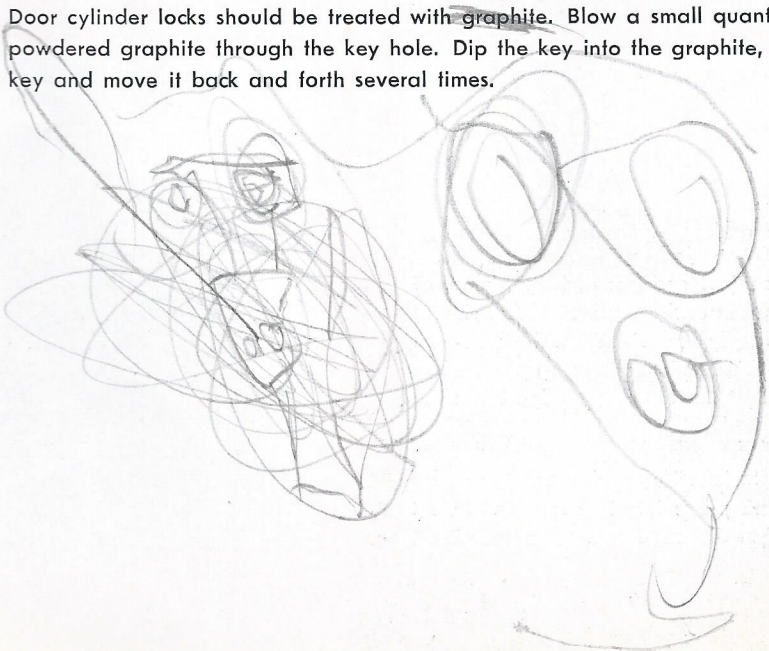



## WHEELS AND TIRES

Under-inflation or over-inflation are the most common causes for tire failures. It is recommended, therefore, that the air pressure be checked frequently, preferably when the tires are normally cold (see page 13).

There are some other causes for premature tire wear which are purely the result of operating conditions and can be controlled by the driver. High speed driving and cornering, skidding to a stop and striking curbs or objects in the road may wear tires more than many miles of careful operation.

The life is affected too by incorrect front wheel alignment or lack of balance of the tire and wheel assemblies.

Avoid overloading the car and protect the tires from intense sunlight, fuel, or oil. Normal wear may be kept at a minimum by interchanging wheels and tires inclusive spare wheel at approximately 4000 km. (2500 miles) intervals. Rotate wheels as indicated below.

The spare wheel is accommodated behind the cab seat back. It is accessible by removing the back.

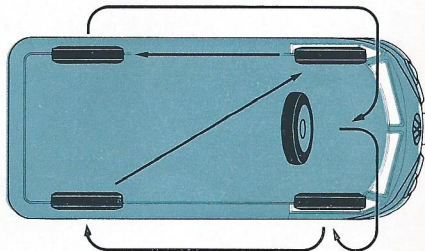
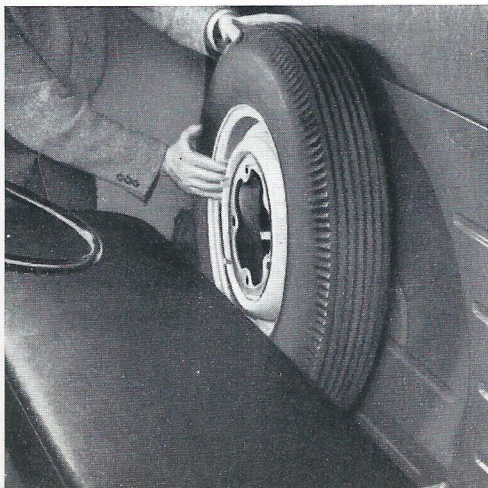



As a precautionary measure, you should employ the better tires on the front axle, if already unevenly worn. To obtain a smooth high speed operation and a long tire life, it is important to have the wheels balanced statically and dynamically when tubes and tires have been repaired.

When the tires are being mounted, the red mark on the sidewall should be aligned with the valve to insure better balancing of tube and tire.

## CHANGING WHEELS

To change a wheel on the road and in the rain certainly is not a pleasant task. However, it will no longer be so difficult for you after you have read these few lines which will teach you how to go about it properly. Underneath the cab seat, you will find the jack and tool kit required for changing tires.

- 1 - Set the handbrake securely and block the wheel opposite to the one being removed to prevent the car shifting off the jack.
- 2 - Insert jack into the square tube below the body.
- 3 - Remove hub cap.

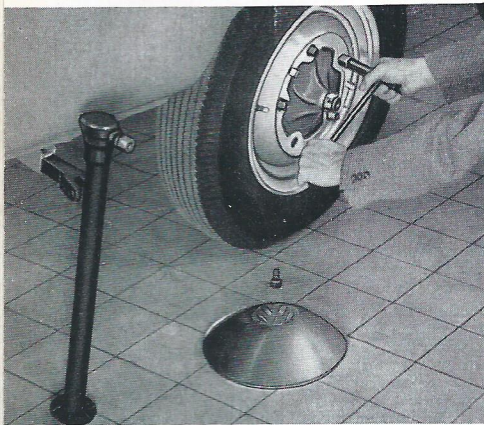

4 - Loosen wheel bolts by means of the socket wrench before wheel is fully jacked up.

5 - Raise jack until tire clears ground.

6 - Remove wheel bolts and remove wheel.

7 - When reinstalling the wheel, operate the jack until the five holes in the wheel are nearly lined up with the holes in the brake drum.

8 - First, insert one wheel bolt only. Tighten it to such a degree as to allow the wheel to be swung around this point by hand, until the remaining holes in the wheel and brake drum coincide.

9 - Insert the remaining bolts until the countersunk heads rest centrally in the corresponding recesses of the disc-wheel.

10 - Tighten all bolts diametrically opposite in turn.

11 - Lower the car sufficiently to contact the tire with the ground and make sure that all bolts are tight.

12 - Install hub cap and make sure that it is tightly seating.

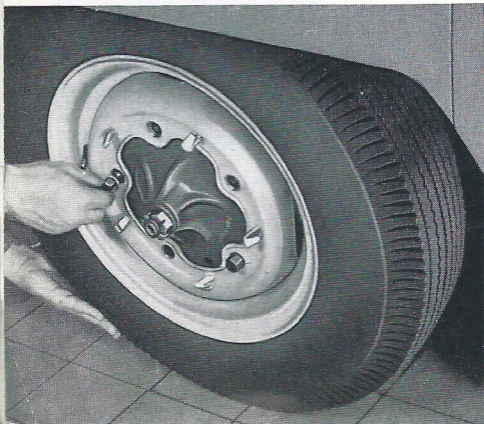

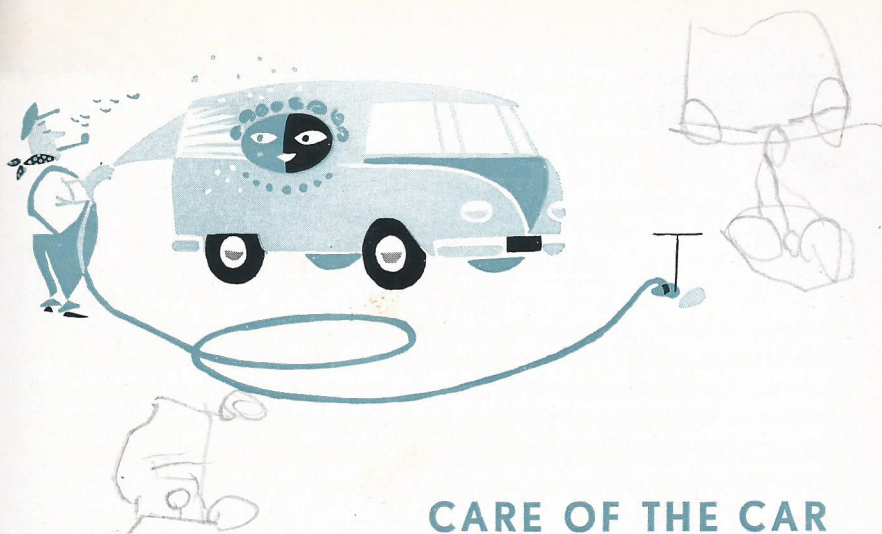

## CARE OF THE CAR

### CLEAN AND NEAT APPEARANCE

To keep the VW TRANSPORTER looking smart and new should be a matter of pride to the driver or owner of the car. You will realize the importance of the paint finish if you consider that it is exposed to the elements; it has to resist dazzling sunshine, rain, dust, and dirt. That is why a periodic care of the body is necessary to retard any disintegrating process.

### WASHING YOUR CAR

Wash your new car frequently during the first weeks. This practice will be of great advantage to the finish. For washing your car you require a soft sponge for the body, a soft brush for the wheels, a sturdy, long-handled brush for the chassis, and plenty of clear water! For drying the car you need a chamois.

The chassis and lower part of the body should first be flushed with water, to soak off the dirt, and afterward a brush should be used.

Apply an even spray of water on the exterior finish of body and wheels until dirt is soaked off. Do not allow a hard shot of water to hit the varnished surface. Using plenty of clear water, dirt should be removed with a sponge. Care should be taken to clean the sponge at short intervals so as to avoid scratches on polished parts. There are some approved shampoos which greatly facilitate this job. Avoid the use of any product which has not been recommended by your service station. It is of utmost importance to wash the body thoroughly with water after the shampoo has been applied to insure that no traces of it remain on the body.



After washing, rub down with a clean chamois to prevent water spots. Some cleaners even render the rubbing down unnecessary and it is sufficient to remove traces of water.

## **PRESERVATION**

means to restore certain greasy substances which have been removed from the finish after a longer time by weather influences. As the greasy substances are vitally important to the elasticity of the finish, it is necessary to apply a protective water-repellent coat of wax on the body. The intensive cleaning effect of the shampoo removes this protective coating so that it should be renewed accordingly.

A preservative specially produced for the finish of your VW TRANSPORTER can be obtained under the designation "L 190" from your service station. The body should be treated with the preservative after the first eight or ten weeks and then regularly at intervals of from six to eight weeks — in any case after each shampoo washing, as already mentioned. Applying the preservative is quite easy; spray it on the body or use a soft cloth, then rub it down when dry, using polishing cotton, or a soft polishing cloth, until prismatic colors can no longer be seen when standing at an angle to the car. Of course, the car must be washed and dried carefully prior to applying the preservative.

## **POLISHING**

You should polish your car only if its appearance has been strongly affected by road dust, sunlight and rain in consequence of an insufficient care and if the application of the preservative no longer restores the original lustre. Avoid the use of abrasives or chemically harmful products, even if their first application seems to give satisfactory results. A special polish for treating our synthetic-resin finish is also obtainable from our service stations under the designation "L 170".

**Never wash or polish the car in sunlight or when the metal is warm.**

## **HOW TO REMOVE SPOTS**

By a mere washing you cannot always remove splashes of tar, oil traces, "baked on" insects, etc. As a matter of principle, such foreign matter should be removed as soon as possible, for if you neglect this rule, permanent damage to the finish may be the result.

**TAR SPOTS.** An unpleasant sight, to be noticed particularly on light-colored cars, are tiny tar spots which show up on hot days when driving on newly tarred roads. Tar splashes have a tendency to corrode the finish within a short time and should be removed immediately when discovered. On the way, you usually have nothing at your disposal but fuel, which may be applied with a soft cloth. Kerosene or turpentine oil may also be used. After this, the treated spots should be washed with a mild, lukewarm soap solution, and rinsed, in order to remove traces of the cleansing agent. It is, however, better to use our preservative already mentioned, which renders the treatment with soap solution unnecessary.

**INSECTS** are caught especially during the night, in hot weather, by the front panel, headlights, and windshield. Once baked on they can hardly be removed with water and sponge, but should be treated with lukewarm soap solution.

**BLOOMING TREES** but more especially lime trees in many instances drop tiny quantities of liquid. Cars that have been parked underneath such trees become "freckled" all over. These stains, too, can be readily taken off with soap solution. A treatment of the cleaned spots with the preservative is strongly recommended.

**CLEANING SUNSHINE ROOF.** Careful attention should be given to the sliding roofs to retain their neat appearance and to keep them waterproof. The fabric top may be cleaned with a brush or whisk broom and thereupon washed with a mild, lukewarm soap solution or shampoo. Finally rinse with clear water. Spots in the fabric should not be removed with fuel, but with an approved cleaning fluid.

A wet top must only dry in the closed position to avoid damp-stains. Especially in a closed garage it is advisable to open the door windows to produce better airing conditions.

**CHROMIUM-PLATED PARTS** should be lightly coated with chromium wax. It is not recommended to use grease or vaseline, as these will bind dust and dirt.

**CARE OF THE UPHOLSTERY.** Leather substitute upholstery should be cleaned by rubbing with a cloth slightly dampened with lukewarm soapy water.

**CLEANING GLASS.** The windows can be cleaned by washing with warm water and wiping dry with a clean, soft linen cloth or chamois. In order to facilitate this task on the windshield, the arms of the windshield wipers may be bent forward. To clean unusually dirty glasses, use alcohol or household ammonia and lukewarm water.





## MAINTENANCE

The VW Service Organisation has made available for you an extensive network of Authorised VW Service Stations, staffed with well trained and experienced men, and equipped with all the required special tools and appliances to service your car. In event the need for service arises when touring, or far away from home, look for the well known VW Service Sign. The workshop displaying this sign is your assurance of the same expert, prompt, and courteous service you are accustomed to receive at home.

In the case you can't get to an Authorised VW Service Station in time, we are giving you some information which, if needed, will help you to carry out normal maintenance work. However, repair jobs which are beyond your capacity can only be performed by your next VW Service Station. There your car will be given expert treatment by those familiar with its construction.

This will save you time, inconvenience, and money.

### SERVICING THE AIR CLEANER

All air used for combustion must pass through the air cleaner. Thus the air is freed from dust and grit which might otherwise reach the engine cylinders. Regular attention should be given to the maintenance. A dirty air cleaner reduces the performance of the engine.

The **Oil Bath Air Cleaner** should be cleaned every 4000 km. (2500 miles). Detach cleaner from intake elbow. Remove dirty oil from oil reservoir and refill with engine oil SAE 20 up to the mark (approx. 0.25 liter/0.5 pint). The filter element should be rinsed in fuel, kerosene, or any other degreasing solution and then dried.

The oil level should be checked and topped up approx. every 2000 km. (1250 miles) in conjunction with the engine oil changes. The oil level should not be above the mark. If the car is mainly operating under desert or other extreme conditions of dust-laden atmosphere, it is up to you to prevent premature wear by more frequently servicing the air cleaner than specified above. The air cleaner must, however, always be cleaned, if there is no thin oil above the sludge at the bottom of the oil reservoir.

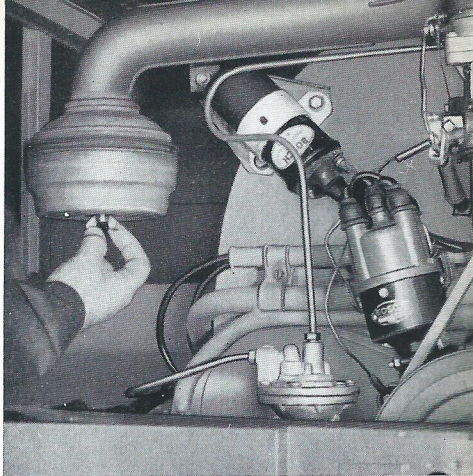

### ADJUSTING THE FAN BELT

To adjust the fan belt, remove nut and outer half of generator pulley. When loosening or tightening nut, insert a screwdriver in the slot cut into the inner half of the pulley, and support it against upper generator housing bolt. The adjustment of the fan belt tension is effected by means of spacer washers situated between the two pulley halves. Belt slackness is taken up by removing one or more washers. If the belt is in too much tension, one or more washers should be added.

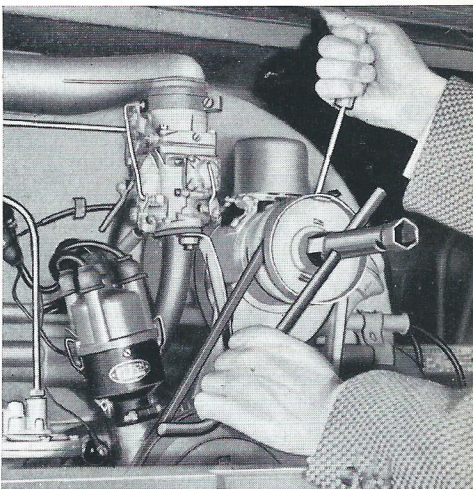

The fan belt should not be too slack, nor should it be too tight. Newly installed belts will stretch to some extent and should, therefore, be checked and adjusted after 50 or 100 kilometers (30 or 60 miles) of running.

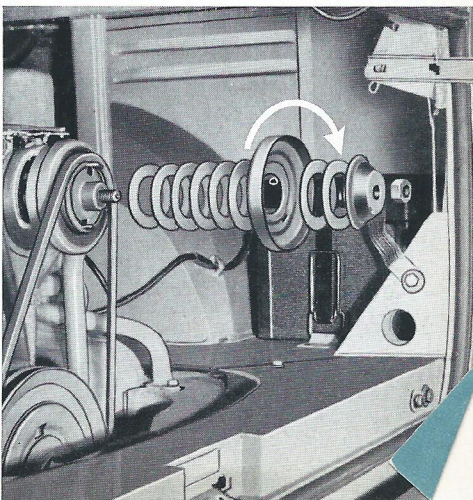



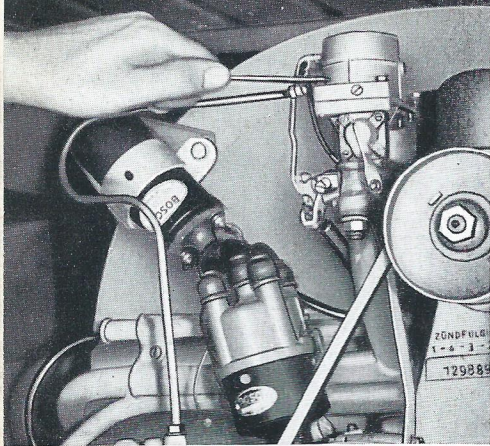

## CLEANING THE CARBURETOR

To clean the carburetor, it is sufficient to tilt back the bowl cover.

### BOWL COVER REMOVAL:

- 1 - Remove intake elbow and air cleaner.
- 2 - Disconnect the fuel line at the carburetor.
- 3 - Remove the three screws that attach the cover to the carburetor bowl.
- 4 - Lift the carburetor bowl cover and tilt it back.
- 5 - If it is intended to completely remove the bowl cover, disconnect the choke control cable and the throttle connector rod.

To re-assemble the unit, proceed in reverse order. Install a new gasket and be sure of its proper position between bowl and bowl cover.

### CLEANING

- 1 - Remove float and lever assembly.
- 2 - Remove the main jet plug and clean main jet, and float bowl.
- 3 - Clean pilot jet air bleed.
- 4 - Clean pilot jet.
- 5 - Clean air correction jet and emulsion tube.
- 6 - Clean the float needle valve.
- 7 - Clean accelerator pump discharge passage.
- 8 - Clean passage connecting float bowl to accelerator pump.

Blow out the jets with compressed air! Never use a pin or a piece of wire, as this will damage the jets.

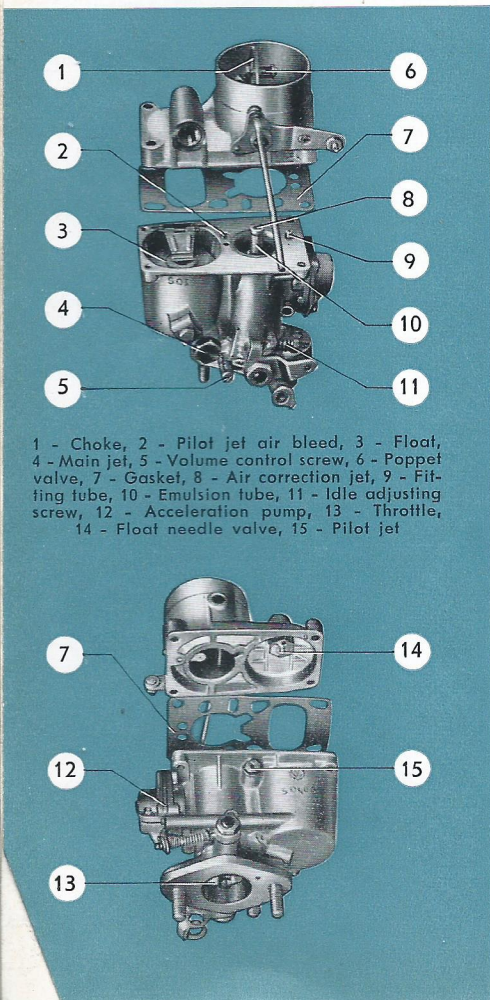

1 - Choke, 2 - Pilot jet air bleed, 3 - Float, 4 - Main jet, 5 - Volume control screw, 6 - Poppet valve, 7 - Gasket, 8 - Air correction jet, 9 - Fitting tube, 10 - Emulsion tube, 11 - Idle adjusting screw, 12 - Acceleration pump, 13 - Throttle, 14 - Float needle valve, 15 - Pilot jet



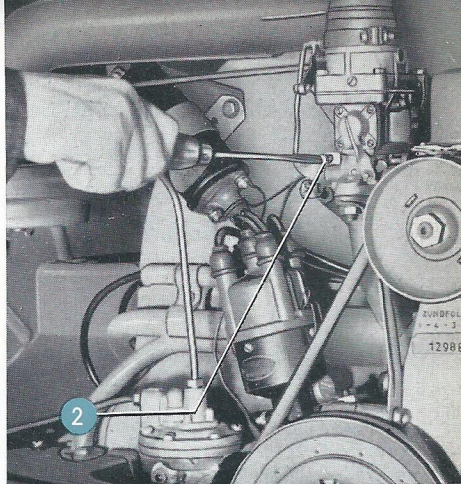
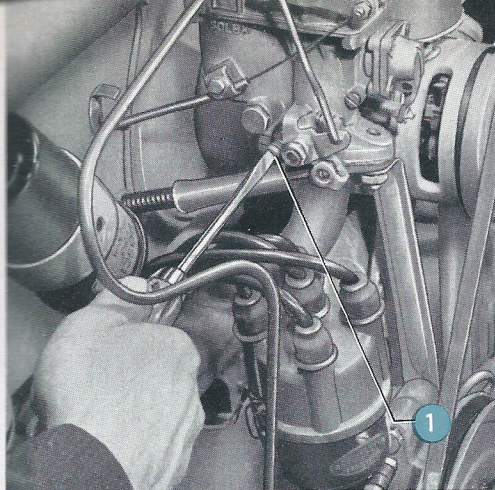

## ADJUSTMENT

The carburetor is tested at the factory and properly adjusted to the engine. Do not alter this adjustment by exchanging the jets, or the venturi for other than the prescribed sizes. This would be detrimental under normal operating conditions, and may result in hard starting, excessive fuel consumption or unsatisfactory engine performance.

Only the idling of the engine may call for a readjustment occasionally. Before attempting to adjust the carburetor, make sure the engine is at normal operating temperature.

- 1 - Turn the volume control screw in until it seats lightly, then back it off approximately  $\frac{3}{4}$  turn.
- 2 - Turn the idling adjusting screw in or out until the approximate idling speed is attained.
- 3 - Gradually turn in the volume control screw until the position is found where the engine just tends to stall, then back it off by  $\frac{1}{4}$  turn.
- 4 - Finally re-adjust the idling adjusting screw until the engine runs at normal idling speed.

The adjustment is perfect if the engine does not stall after the throttle either is suddenly opened or suddenly shut. Poor idling may also be the result of damaged gaskets, intake manifold flanges not sufficiently tightened, faulty ignition or leaky valves.

Skilled hands and experience are required to check and adjust the carburetor. For this reason you should leave this job to an Authorised VW Station.



## VALVE ADJUSTMENT

The following procedure should be carried out only in such emergencies when it is impossible for you to reach a VW Service Station.

Valve clearance should be 0.10 mm. (.004") with the engine cold. The valve clearance increases when the engine warms up.

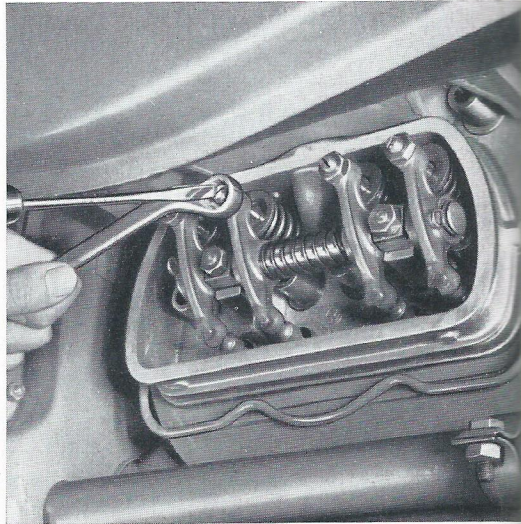
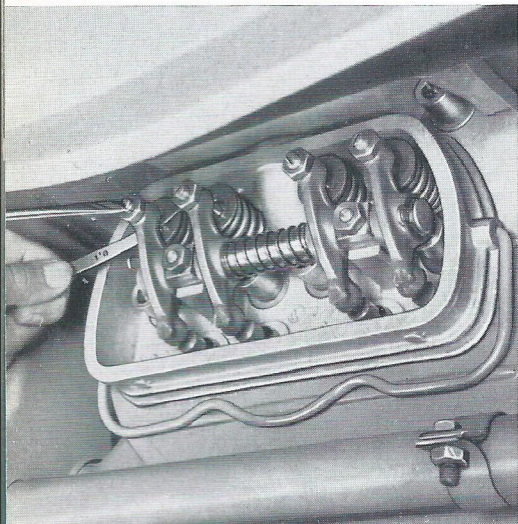

For this reason, **only adjust valve clearance when the engine is cold.**

Valve adjustment may be made in the following sequence: 1<sup>st</sup> — 2<sup>nd</sup> — 3<sup>rd</sup> — 4<sup>th</sup> cylinder. Adjust the valves when the piston of the corresponding cylinder is in top dead center position of the compression stroke.

Starting with the 1<sup>st</sup> cylinder, crank the engine over slowly to the left by the fan pulley, until both valves are in fully closed position and the timing mark on the pulley is in line with the vertical jointing faces of the crankcase.

Check the valve clearance with a feeler gauge, inserting the gauge between the adjusting screw of the rocker arm and end of the valve. If the clearance requires adjustment, loosen the lock nut of the adjusting screw and turn the

adjusting screw as required to obtain the proper clearance. Tighten the lock nut and recheck the clearance. Readjust if necessary.

Check and adjust the other valves to the proper clearance in this manner by turning the crankshaft anti-clockwise another  $180^{\circ}$  for each cylinder.

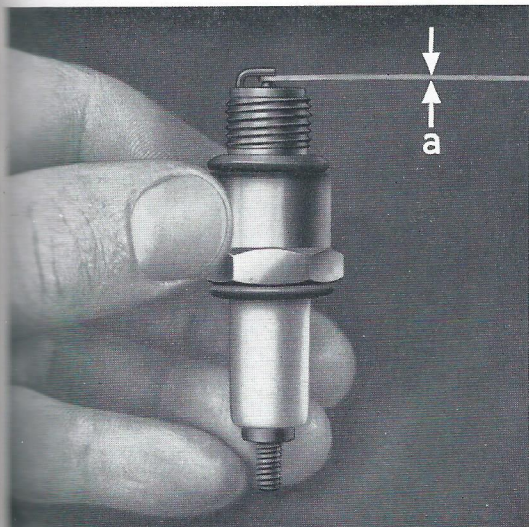

$a = 0.6-0.7$  mm.  
.024"—.027"

## CHECKING THE SPARK PLUGS

The spark plugs must be thoroughly maintained for easy starting and economical operation. Inspect their exterior before installation in the engine.

Electrodes and insulator

- medium grey — good adjustment of carburetor and correct performance of spark plug,
- black — mixture too rich,
- lightgrey — mixture too lean,
- oiled up — failure of spark plug or worn out cylinder.

Clean the spark plugs with a brush and a chip of wood and blow them out. Inspect the spark plugs for cracked insulators and burned or pitted electrodes. The insulator should be clean and dry on the outside as well to avoid short



circuits. Check the electrode gap (0.6—0.7 mm = .024—.027") and reset if necessary by bending the outer electrode. Look for a proper gasket before installing the plug. Generally speaking you may count on a service life of the spark plugs up to 15 000 km. (9300 miles).

## IGNITION AND TIMING

Particular attention should be attached to the importance of correct ignition timing. The engine operation will be seriously affected if the ignition breaker points are not properly timed and correctly spaced. In many cases poor performance, high fuel consumption and even severe damage to the engine are the result of unskilled setting of the ignition. Normally, the adjustment should be carried out by an Authorised VW Service Station when the car is brought in for regular inspection. A few practical hints are given herewith, however, because in our experience damage is apt to result if the technical facts and data are not known.

## ADJUSTING CONTACT POINTS

Remove distributor cap and rotor. The breaker contact points are adjusted by cranking the engine until the fiber block on the contact arm rests on the highest point of the cam lobe. Then loosen the stationary point locking screw and turn the eccentric adjusting screw until the correct gap is obtained. Use a feeler gauge of the proper thickness (0.4 mm. = .016"). Tighten lock screw and recheck the gap.

If the points are burned, rough or pitted, replace them. The distributor cap should be clean and dry, inside and out, so as to avoid short circuits.

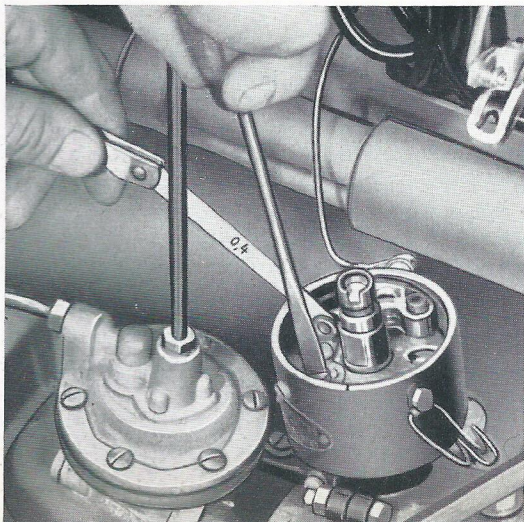

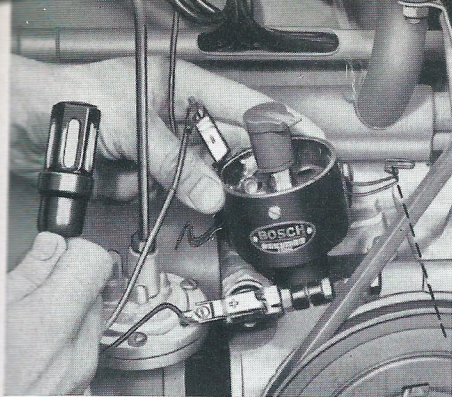

**AFTER THE CONTACT POINTS HAVE BEEN ADJUSTED, IT IS ABSOLUTELY NECESSARY TO CHECK THE IGNITION TIMING.**

## **IGNITION TIMING**

Crank the engine until the mark of the crankshaft pulley lines up with the vertical crankcase jointing faces and the distributor rotor arm is in the position for firing on the No. 1 cylinder (see mark on rim of distributor base). Loosen the lock screw below the distributor base and rotate the distributor body clockwise until the contact points are closed. Now switch on the ignition and rotate the distributor slowly counter-clockwise until the contact points just mark to open. This may be seen and heard, for a spark will jump from one point to the other. This setting corresponds to a spark advance of  $7.5^{\circ}$  before T. D. C. To obtain a more accurate adjustment for maximum results, it is advisable to use a test lamp (6 volts) or an ignition timing light. The test lamp should be connected to the distributor primary lead terminal and to the ground. The lamp will light up as long as the contact points are kept open by one of the four cam lobes of the distributor shaft.

After the adjustment is completed, tighten the lock screw, replace the rotor and clamp the cap on the distributor.

## **EXCHANGING FUSES**

The fuse box is located below the parcel shelf. When a fuse has blown out, it is not sufficient to merely replace it by a new one. Inspect the electrical system for evidence of short circuits or other faults that may have caused the fuse to blow out. Under no circumstances should you use a fuse patched up with tin-foil or wire, because this may result in severe damage. We suggest that you carry with you a set of spare fuses (8/15 amp.).

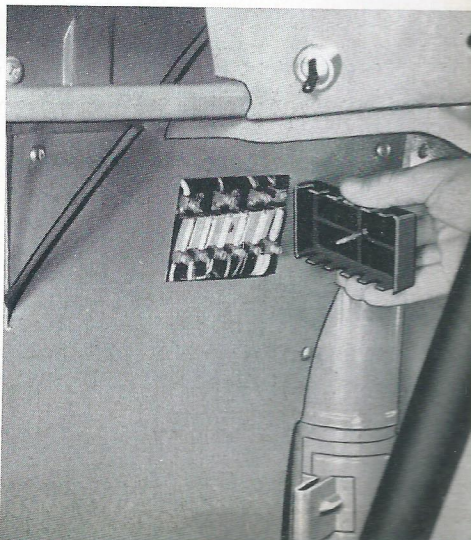



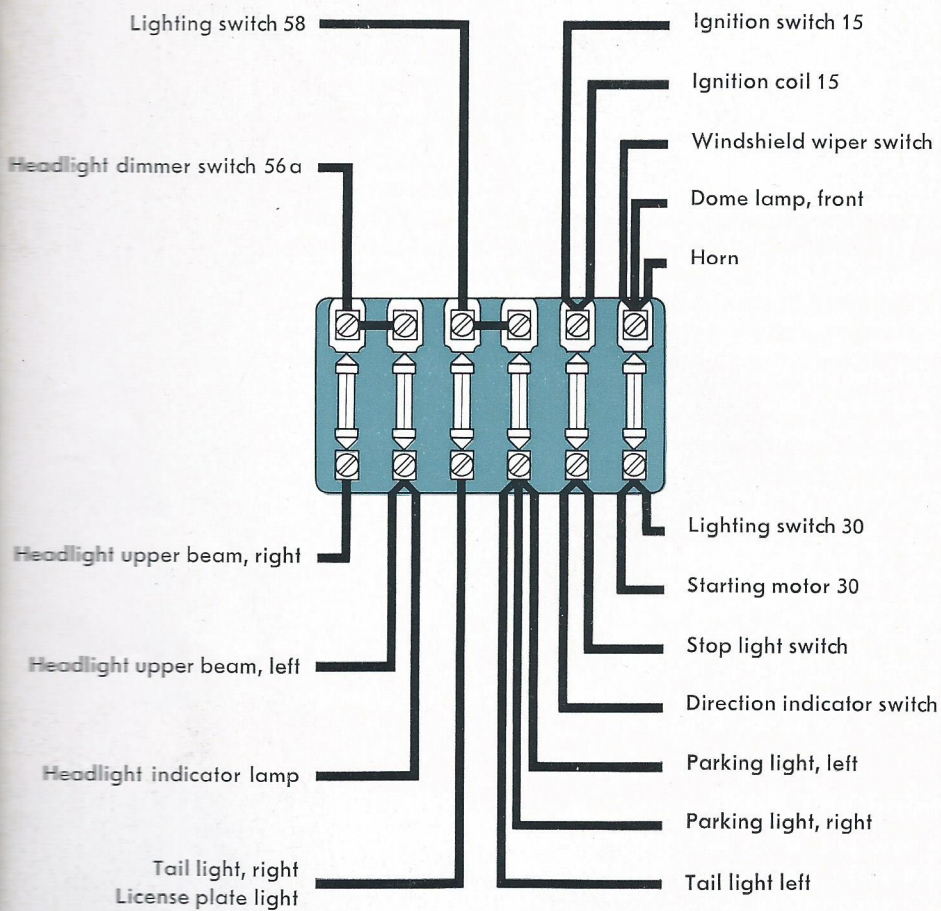

Fuse box below the instrument panel tray

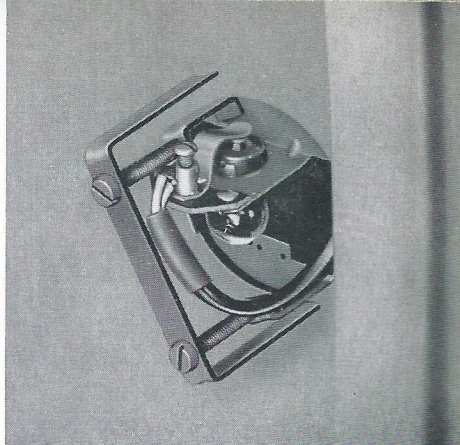

### **STOP AND LICENSE LIGHT BULB REPLACEMENT**

The stop light is accessible by removing the slotted screws in the glass rims. Make sure that the bulbs properly contact the terminals.

The tail lights and the license plate light are accessible by lifting the engine compartment lid.

### **WARNING AND INSTRUMENT LIGHT BULB REPLACEMENT**

The lamps for oil pressure, charging, direction indicator and headlight main beam control as well as the speedometer lamps are accessible under the instrument panel. They can easily be pulled out from their sockets.

### **BATTERY MAINTENANCE**

Ready starting of the engine depends upon perfect condition of the battery. Inspect the battery regularly as prescribed in the Maintenance Chart and even more frequently under conditions of extreme heat.

The state of charge of the battery may be checked by means of a battery hydrometer. The specific gravity of the battery liquid will increase with the charging of the battery. Tested with the hydrometer, the gravity can be read from the scale of a float.

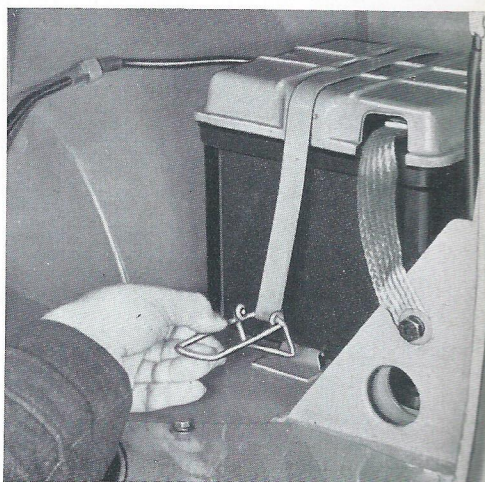



|                                |                |
|--------------------------------|----------------|
| Battery fully charged .....    | 1.285 = 32° Bé |
| Battery semi-charged .....     | 1.230 = 27° Bé |
| Battery fully discharged ..... | 1.142 = 18° Bé |

In addition, a volt-ammeter test should be made to insure that the battery is in good operating condition and able to provide the necessary current. The voltage of each cell should not fall below 1.6 volts while taking the reading (10—15 seconds). Otherwise the cell is discharged or defective. Under no-load conditions each charged cell should read 2 volts.

Add distilled water to each cell to bring the level to approximately 15 mm (.59") above the plates. Losses by evaporation may only be replenished by adding distilled water. Never add acid, unless it is known that acid has been spilled from the battery. Check specific gravity afterwards and compensate if necessary.

Use a stiff brush to remove corrosion from both posts and terminals. Coat the clean posts and terminals with light grease or vaseline to prevent corrosion. Then tighten securely and make sure that there is a proper connection to the ground.

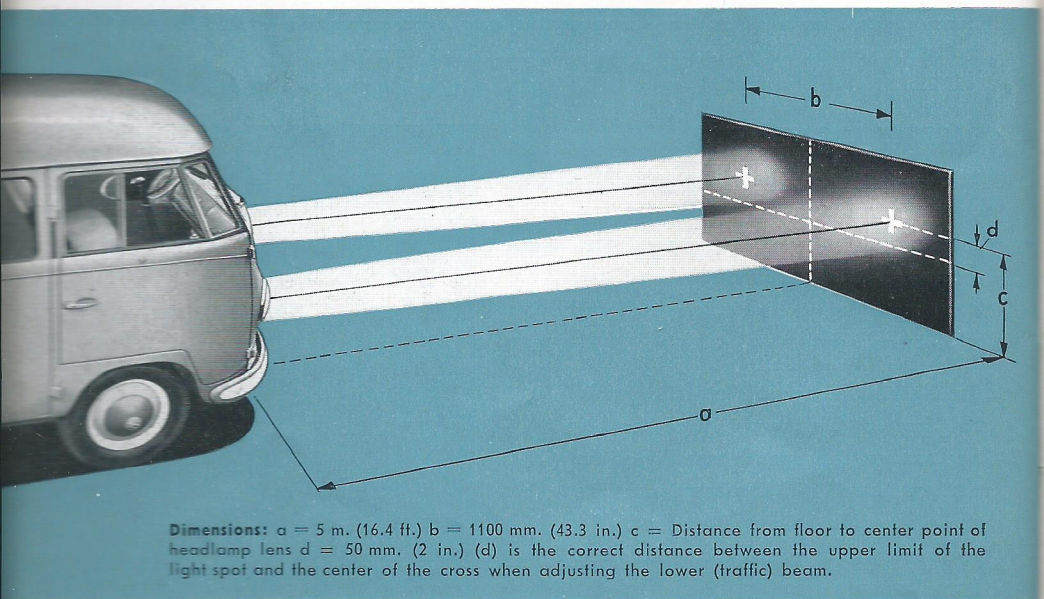

## AIMING THE HEADLIGHTS

If no headlight aiming device is available, proceed as follows:

- 1 - Place the unladen car on a level position with a dark-colored vertical screen 5 m. (16.4 feet) ahead.
- 2 - Next draw two cross lines on the screen according to the scetch.
- 3 - The longitudinal center line (car axis) must hit the center of the screen exactly between the two cross marks.
- 4 - Switch on the upper (country) beams and check the beams at the cross marks.
- 5 - Independent adjustment of both horizontal and vertical aim is provided with the adjustment screws accessible from the front of the headlight rim.

### VERTICAL ADJUSTMENT

#### Right Headlight:

Turn lower screw to left — Beam swings up.  
Turn lower screw to right — Beam swings down.

#### Left Headlight:

Turn upper screw to left — Beam swings down.  
Turn upper screw to right — Beam swings up.

### HORIZONTAL ADJUSTMENT

#### Right Headlight:

Turn upper screw to right — Beam swings to right.  
Turn upper screw to left — Beam swings to left.

#### Left Headlight:

Turn lower screw to left — Beam swings to right.  
Turn lower screw to right — Beam swings to left.

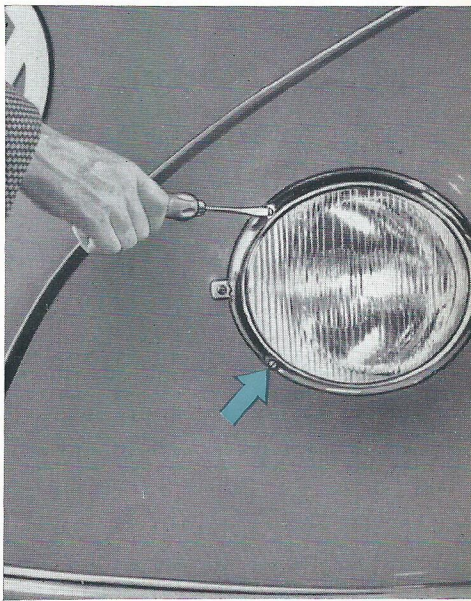



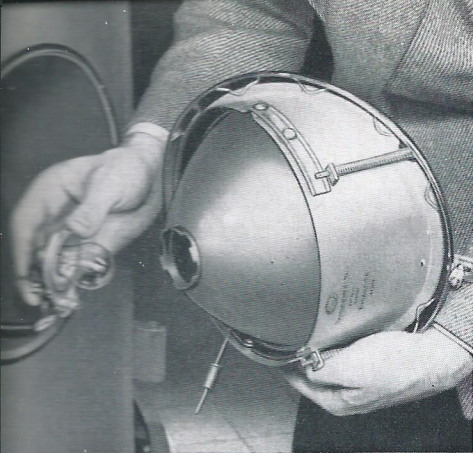

## HEADLIGHT BULB REPLACEMENT

Loosen the slotted screw at the headlight rim. Pull out the lens and reflector unit, unhook the tension spring, and pull out the socket. When replacing the bulb, make sure the new bulb is clean and that it is not loose in the socket. When a broken lens is being replaced, the reflector should not be touched or wiped off.

## BRAKE ADJUSTMENT

Brake adjustment should be performed by an Authorized VW Service Station. However, if an emergency arises where the brakes must be adjusted before you can reach the next repair shop, the following procedure for bleeding and adjusting can be used: The master cylinder is accessible by lifting the inspection plate situated in the floor of the driver's compartment.

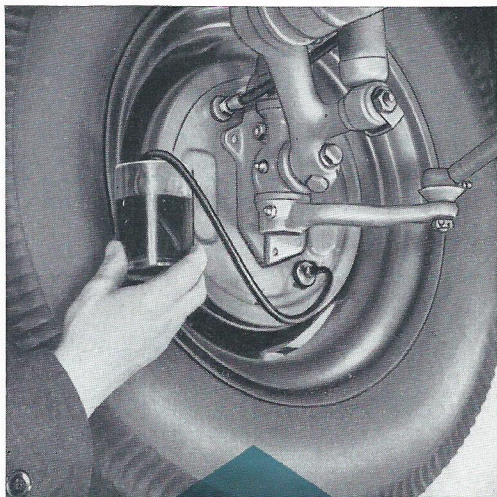
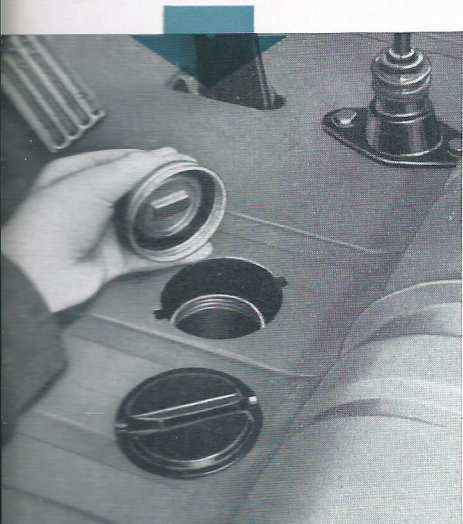

To fill up, use only VW GENUINE BRAKE FLUID or LOCKHEED BRAKE FLUID. The fluid reservoir should be kept at least  $\frac{3}{4}$  full at all times.

## BLEEDING HYDRAULIC SYSTEM

The hydraulic brake system must be bled whenever a fluid line has been disconnected or air has got into the system. The presence of air will cause "spongy" brake pedal operation.

- 1 - Remove rubber cap of the bleeder valve of one wheel cylinder and attach one end of the brake bleeder hose to the valve.
- 2 - Place the opposite end of the bleeder hose in a glass container partly filled with brake fluid so that the end of the hose is submerged.
- 3 - Turn the bleeder valve to the open position (1 to 2 turns).
- 4 - Pump the brake pedal several times until bubbles cease to appear in the container. Make sure that enough brake fluid remains in the fluid reservoir, since otherwise air will be sucked in.
- 5 - Keep the brake pedal in the fully depressed position until the bleeder valve is closed.
- 6 - Remove bleeder hose and replace bleeder valve rubber cap.
- 7 - Repeat the operations on the other wheels. Finally check and, if necessary, top up fluid level of master cylinder reservoir.

## ADJUSTING HYDRAULIC BRAKE

Too much free travel of the brake pedal is an indication that the clearance between brake shoes and brake drums has become too great. The amount of wear can be gauged by looking through the adjusting hole in the brake drum. The brake shoes should be relined when the visual inspection, to be carried out every 12 000 km. (7500 miles), reveals excessive wear.

The brake shoes are to be adjusted as follow:

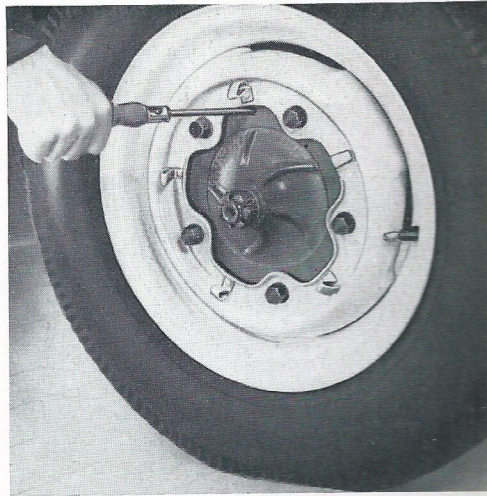

- 1 - Jack up the car and turn forward the wheel to be adjusted, until the hole in the brake drum is in line with one of the adjusting nuts.



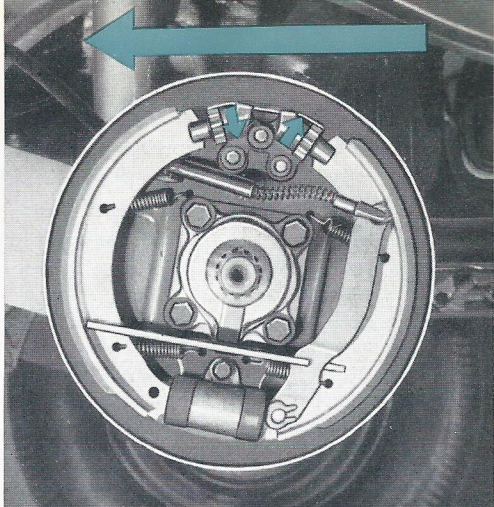
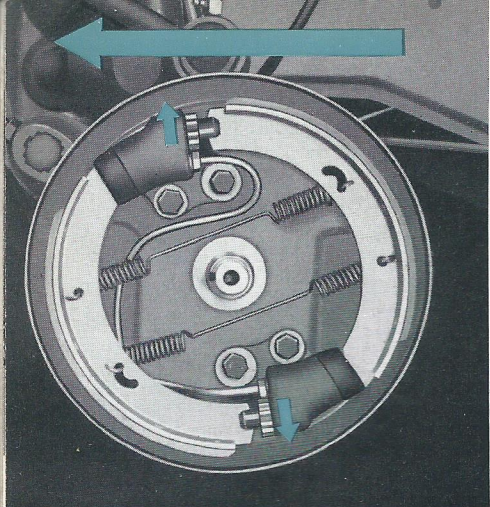

- 2 - Insert a screwdriver through the hole and turn the adjusting nut in the direction indicated by the arrows until a light drag is noted when wheel is turned by hand.
- 3 - Repeat procedure on the other adjusting nut. Note the opposite turning direction of the two nuts.
- 4 - Back off the adjusting nuts by 3 to 4 teeth.
- 5 - Repeat the above operations on the other wheels.

When adjusting the rear wheel brakes, the hand brake must be released.

### ADJUSTING HAND BRAKE

- 1 - Jack up both rear wheels.
- 2 - Tighten adjusting nuts on the front ends of the brake cables to a degree which will still allow the rear wheels to turn freely when the hand brake is released.
- 3 - Pull up hand brake lever by two notches and make sure both rear wheels have the same braking effect. At the fourth notch it should be impossible to turn the wheels by hand.

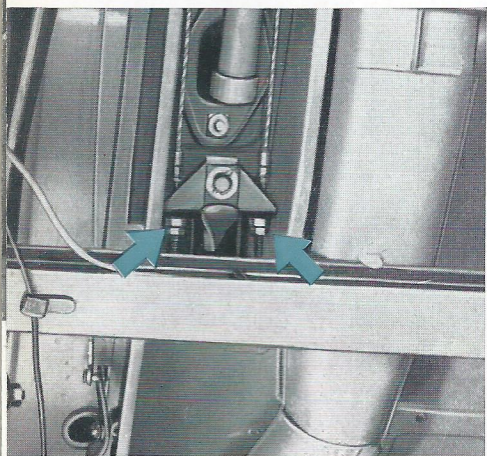

## **STEERING GEAR**

Only a minimum of maintenance is necessary to the steering gear. The need for adjustment will be evidenced by the development of excess free play in the steering wheel. The play should be as small as possible, but care must be taken that the front wheels resume their straight-ahead position after the car has taken a turn. As special experience is needed to properly service this unit, all operations or adjustments required should only be performed by an Authorised VW Service Station.

The maintenance service provides the regular adjustment of the torsion arm link pins on the front axle. After this operation, it is absolutely necessary to check the toe-in of the front wheels.

## **FRONT WHEEL BEARINGS**

We recommend to refer this operation to an Authorised VW Service Station, as mal-adjustment may cause severe damage to the roller bearings.



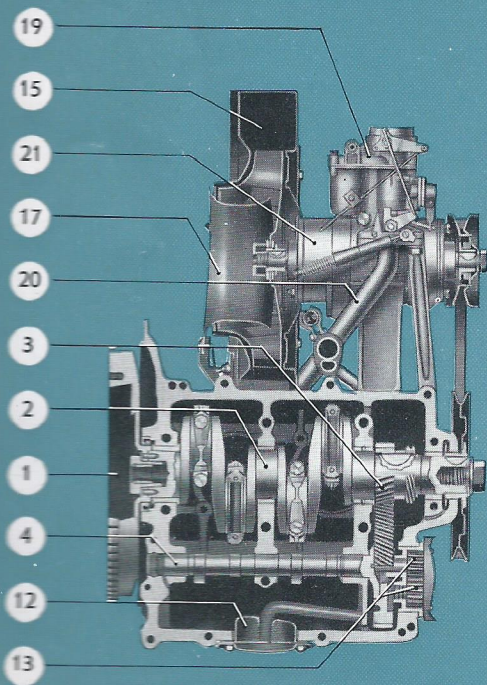
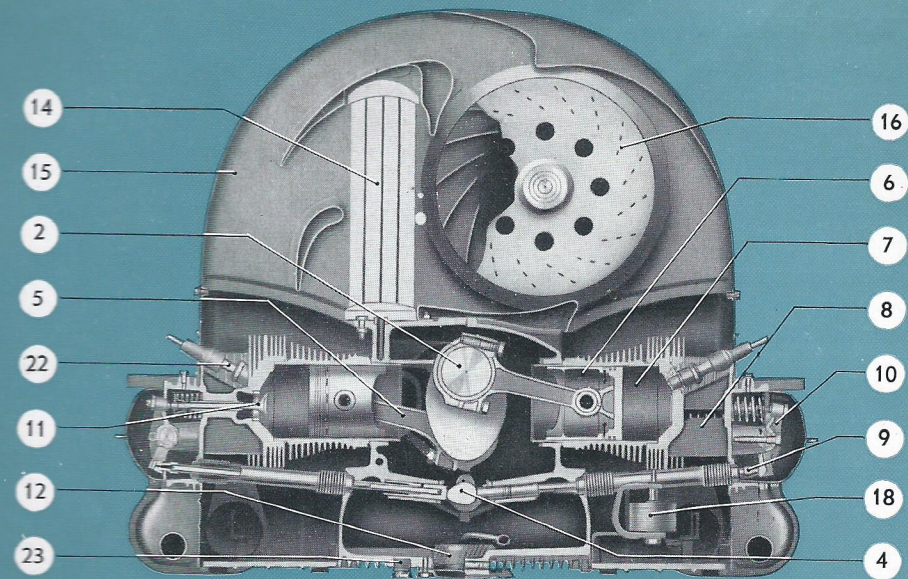

## ENGINE

- 1 - Flywheel
- 2 - Crankshaft
- 3 - Crankshaft timing gear
- 4 - Camshaft
- 5 - Connecting rod
- 6 - Piston
- 7 - Cylinder
- 8 - Cylinder head
- 9 - Valve push rod
- 10 - Rocker arm
- 11 - Valve
- 12 - Oil strainer
- 13 - Oil pump
- 14 - Oil cooler
- 15 - Fan housing
- 16 - Fan
- 17 - Throttle ring
- 18 - Thermostat
- 19 - Carburetor
- 20 - Intake manifold
- 21 - Generator
- 22 - Spark plug
- 23 - Oil drain plug





## GENERAL DESCRIPTION

### ENGINE

The engine, located in the rear of the car, is mounted in a floating way on the recessed flange of the rubber-cushioned gearbox. Two pairs of cylinders are horizontally opposed. Each pair has one mutual cylinderhead made of light alloy. The overhead valves are located in the cylinderhead and are operated by means of push rods and rocker arms. The short and counter-balanced crankshaft rests in four replaceable special light alloy bearings and is heat-treated at its four points of support. It drives the camshaft by means of helical gears. The connecting rods are fitted with interchangeable steel-backed lead-bronze bearings. The pistons are made of aluminium alloy.

A downdraft carburetor produces the fuel and air mixture to supply the cylinders. The engine is equipped with battery ignition.

The oil pump of the full pressure lubrication is driven by the camshaft and sucks the oil from the crankcase through a strainer, from where it will reach the points of lubrication via an oil radiator. In cold weather, when the oil is of higher viscosity, an oil pressure relief valve makes it possible for the engine to be lubricated directly, that is, by avoiding the oil cooling system.

The air cooling of the engine is done by means of a fan, which is attached to the extended generator shaft and driven by a V-belt. The fan sucks in air through an opening in the fan housing, and the air cools the engine by passing through the cylinder fins. A thermostat controls the cooling air intake and insures a proper balance of the operating and heating temperatures.



## **TRANSMISSION AND FINAL DRIVE**

Power from the engine is transmitted to the gears via a dry single-disc clutch. The transmission provides four speeds forward and one reverse. All models are equipped with synchromesh devices for the 2<sup>nd</sup>, 3<sup>rd</sup>, and 4<sup>th</sup> gears, which are helically cut to provide silent operation. The drive pinion and the ring gear of the rear axle are cut spirally. The two floating rear axle shafts are flexibly supported in the differential housing.

Spur wheel reduction gears are provided on the outer ends of the rear axle tubes.

## **AXLES AND STEERING**

The front axle consists of two rigidly joined tubes containing the torsion springs, the outer ends of which carry the trailing suspension arms. The front wheels are sprung independently. The suspension arms form parallelograms assuring proper steering and suspension geometry under all driving conditions. Stops with rubber buffers are provided to prevent excessive rebound.

The rear axle is of the swing half-axle type. The rear wheels are also independently sprung by means of adjustable round steel torsion bars. Double acting hydraulic shock absorbers of the telescope type in front and rear prevent rebound.

The foot brake, which operates on all four wheels, is of the hydraulic type. The hand brake operates on the rear wheels through cables.

The steering gear, which is of a worm and cam follower type, actuates the steering arms of the independent suspension by a draglink and a divided tie rod.

## **BODY**

The body is of a self-supporting, all-steel design, provided with a strengthening frame to support the axles. The position of the load space within the wheelbase insures an even distribution of the load on all four wheels, no matter how the load is placed. The load space is accessible through a double-wing door from the side and through a hinged rear panel. The tarpaulin of the Pick-Up as well as the hoopsticks can easily be removed and replaced. The driver's compartment, for 3 persons, offers exceptional driving visibility. Adequate ventilation is insured by ventilator wings and sliding windows in addition to a fresh air regulator above the windshield.

## **HEATING SYSTEM**

Heated air, which is taken from the air flow warmed up by the engine, is guided through the middle of the car into the driver's compartment by one duct in the floor and two vents at the windscreen to keep it free from frost. The passenger's compartment of the Micro Bus is heated by additional vents under the rear seats. The heating system can be controlled from the driver's seat by means of a rotary knob.



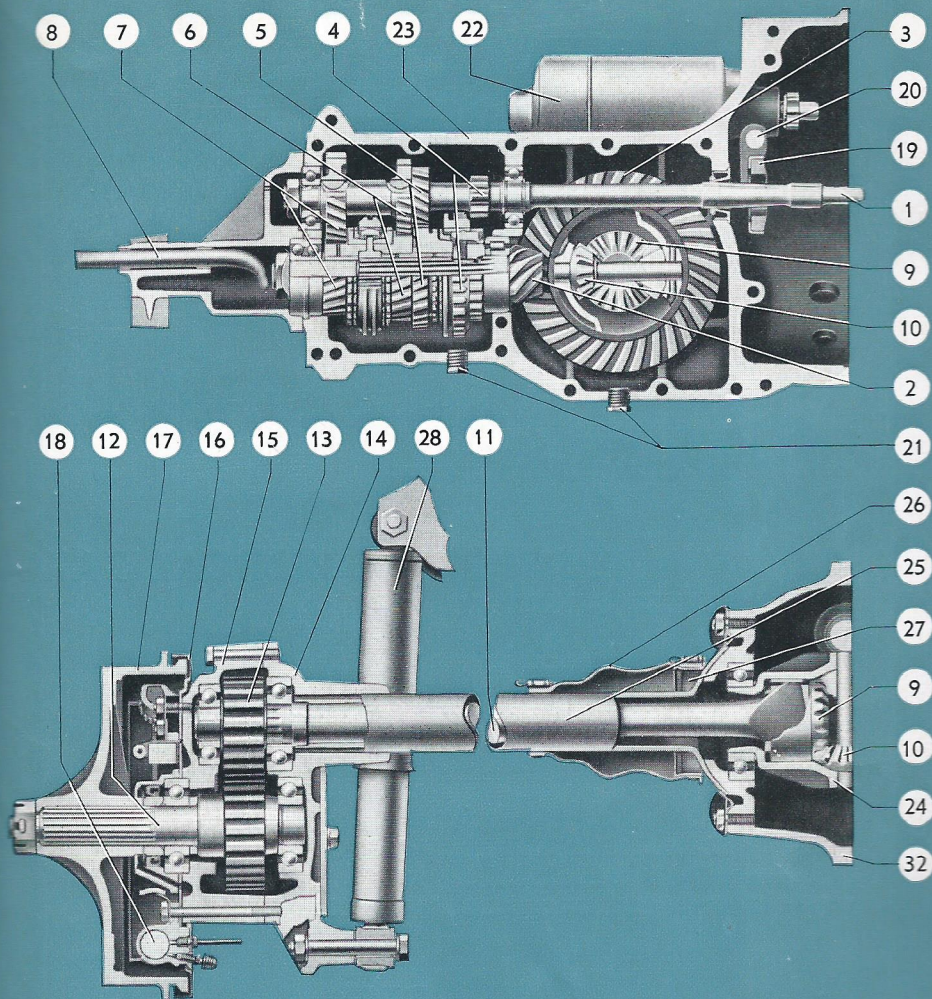

## REAR AXLE AND TRANSMISSION

- |                            |                                      |                                |
|----------------------------|--------------------------------------|--------------------------------|
| 1 - Main drive shaft       | 11 - Rear axle shaft                 | 19 - Clutch release bearing    |
| 2 - Drive pinion           | 12 - Reduction driven gear and shaft | 20 - Clutch operating shaft    |
| 3 - Ring gear              | 13 - Reduction drive gear            | 21 - Drain plug                |
| 4 - 1 <sup>st</sup> gear   | 14 - Reduction gear case             | 22 - Starting motor            |
| 5 - 2 <sup>nd</sup> gear   | 15 - Reduction gear case cover       | 23 - Transmission case         |
| 6 - 3 <sup>rd</sup> gear   | 16 - Brake back plate                | 24 - Reduction gear case       |
| 7 - 4 <sup>th</sup> gear   | 17 - Brake drum                      | 25 - Rear axle tube            |
| 8 - Transmission shift rod | 18 - Brake wheel cylinder            | 26 - Dust sleeve               |
| 9 - Differential side gear |                                      | 27 - Axle tube retainer        |
| 10 - Differential pinion   |                                      | 28 - Telescopic shock absorber |





|                            |  |
|----------------------------|--|
| Battery .....              | 6 Volts, 77 Ampere Hours   |
| Starter .....              | Electric, 6 Volts, .4 HP.  |
| Generator .....            | 6 Volts, 160 Watts at 2500 R. P. M.,<br>with Voltage Regulator   |
| Ignition Distributor ..... | Centrifugal spark advance  |
| Firing Order .....         | 1—4—3—2  |
| Spark advance .....        | 7.5° before T. D. C.   |
| Breaker Point Gap .....    | 0.4 mm. (.016")  |
| Spark Plugs .....          | Bosch W 225 T 1<br>Beru 225/14 u2<br>Lodge H 14 or HN<br>Champion L 10 S<br>AC F 10<br>Auto-Life AE 6 or AER 6<br>KLG F 70 |
|                            | } 14 mm.   |
| Spark Plug Gap .....       | 0.6 to 0.7 mm. (.024" to .027")  |

## CLUTCH

|                       |                        |
|-----------------------|------------------------|
| Design .....          | Single Disc, Dry       |
| Pedal Free-Play ..... | 10 to 20 mm. (1/2"—1") |

## TRANSMISSION

4 Forward Speeds, 1 Reverse, 2<sup>nd</sup>, 3<sup>rd</sup>, and 4<sup>th</sup> Gears, Synchronized and Silent.

|                   |                   |
|-------------------|-------------------|
| Gear Ratios ..... | First: 3.60 : 1   |
|                   | Second: 1.88 : 1  |
|                   | Third: 1.23 : 1   |
|                   | Top: 0.82 : 1     |
|                   | Reverse: 4.63 : 1 |

## REAR AXLE

Power is transmitted through helically-cut drive pinion and ring gear, via two swinging axles and spur wheel reduction gears to the rear wheels.

|   |  |
|---|--|
| Ratio .....   | 4.4 : 1  |
| Oil Capacity of Transmission and<br>Rear Axle ..... | Metric — 2.5 Liters<br>U. S. — 5.3 Pints<br>Imp. — 4.4 Pints |

## REAR WHEEL REDUCTION GEARS

|  |  |
|--|--|
| Ratio .....                                | 1.4 : 1  |
| Oil Capacity of Reduction Gear Cases ..... | Metric — 0.25 Liter<br>U. S. — 0.5 Pint<br>Imp. — 0.4 Pint |



## CHASSIS

|  |  |
|--|--|
| Suspension, Front .....                  | Two Multi-leaf Torsion Bars  |
| Suspension, Rear .....                   | One Round Torsion Bar Spring<br>on Each Side   |
| Shock Absorbers .....                    | Double Acting Hydraulic Type,<br>Front and Rear  |
| Steering .....                           | Ross cam and lever steering gear<br>with rolling stud contact and hydraulic<br>steering damper |
| Turns of Steering Wheel, Lock to Lock    | 2.8  |
| Turning Circle .....                     | 12 Meters (39 Feet)  |
| Foot Brake .....                         | Hydraulic Brake, Operating on all<br>4 Wheels  |
| Hand Brake .....                         | Mechanical, Operating on Rear Wheels   |
| Wheels .....                             | 4 <sup>1</sup> / <sub>2</sub> K × 15, Drop-Center Type   |
| Tires .....                              | 6.40—15  |
| Inflation Pressure .....                 | Front: 2.0 atm. (28 lbs./Sq. In.)<br>Rear: 2.3 atm. (33 lbs./Sq. In.)                          |
| Wheel Base .....                         | 2400 mm. (7 Ft. 10.5 In.)  |
| Track (Tread) .....                      | Front: 1370 mm. (4 Ft. 5.9 In.)<br>Rear: 1360 mm. (4 Ft. 5.6 In.)                              |
| Camber of Front Wheels .....             | 0° 40'   |
| Toe-in (Car in fully laden condition) .. | 2—5 mm. = .08 In.—.2 In.   |
| Castor .....                             | 0°   |

## DIMENSIONS AND WEIGHTS

|                        | Delivery Van<br>Micro Bus<br>Kombi | Micro Bus<br>De Luxe | Pick-Up<br>without<br>tarpaulin | Pick-Up<br>with<br>tarpaulin | Ambulance |
|------------------------|------------------------------------|----------------------|---------------------------------|------------------------------|-----------|
| Length .....           | 4.19 m.                            | 4.22 m.              | 4.19 m.                         | 4.19 m.                      | 4.19 m.   |
| Width .....            | 1.73 m.                            | 1.75 m.              | 1.71 m.                         | 1.71 m.                      | 1.73 m.   |
| Height .....           | 1.94 m.                            | 1.94 m.              | 1.92 m.                         | 2.21 m.                      | 1.94 m.   |
| Ground Clearance ..... | .24 m.                             | .24 m.               | .24 m.                          | .24 m.                       | .24 m.    |

### Delivery Van and Kombi

#### Load Space

|                   |         |                      |
|-------------------|---------|----------------------|
| Mean Length ..... | 2.70 m. | } approx. 4.8 cu. m. |
| Mean Width .....  | 1.50 m. |                      |
| Mean Height ..... | 1.35 m. |                      |

#### Luggage Compartment in Micro Bus and Kombi

|                   |         |             |
|-------------------|---------|-------------|
| Mean Length ..... | .70 m.  | } .8 cu. m. |
| Mean Width .....  | 1.45 m. |             |
| Mean Height ..... | .80 m.  |             |

## Pick-Up

### Loading Area

|  |         |                      |
|--|---------|----------------------|
| Length .....                                 | 2.60 m. | } approx. 4.2 Sq. m. |
| Width .....                                  | 1.57 m. |                      |
| Height of Side Boards .....                  | .38 m.  |                      |
| Height of Tarpaulin above Loading Area ..... | 1.20 m. |                      |

### Locker

|                     |            |                      |
|---------------------|------------|----------------------|
| Length .....        | 1.20 m.    | } approx. 1.9 Sq. m. |
| Width .....         | 1.60 m.    |                      |
| Height .....        | .34 m.     |                      |
| Loading Space ..... | .65 cu. m. |                      |

## WEIGHT IN Kg.

|                                 | Proper Weight | Unladen Weight | Payload | Total Weight | Number of Seats |
|---------------------------------|---------------|----------------|---------|--------------|-----------------|
| Delivery Van .....              | 920           | 1020*          | 830     | 1850         | 3               |
| Pick-up without Tarpaulin ..... | 950           | 1050*          | 800     | 1850         | 3               |
| Pick-up with Tarpaulin .....    | 950           | 1085*          | 765     | 1850         | 3               |
| Kombi .....                     | 940           | 1040*          | 810     | 1850         | 3               |
| Micro Bus .....                 | 1085          | 1110           | 740     | 1850         | 8               |
| Ambulance .....                 | 1185          | 1210           | 640     | 1850         | 7               |

\* including driver

|                                    | Front | Rear |
|------------------------------------|-------|------|
| Permissible Axle Loads in kg. .... | 950   | 1000 |

## PERFORMANCE

|                                    |  |
|------------------------------------|--|
| Maximum and Cruising Speed .....   | 80 km./h. (50 M. P. H.) at 3300 R. P. M. |
| Climbing Ability First Speed ..... | 24.5 % (13.5°)                           |
| Second Speed .....                 | 12 % (6°)                                |
| Third Speed .....                  | 7.5 % (4.5°)                             |
| Top Speed .....                    | 4 % (2.5°)                               |

## FUEL CONSUMPTION

|                              |                                 |
|------------------------------|---------------------------------|
| Average Consumption .....    | Metric — 9.5 Liters per 100 km. |
|                              | U. S. — 25 Miles per Gallon     |
|                              | Imp. — 30 Miles per Gallon      |
| Pick-up with tarpaulin ..... | Approx. — 10 Liters per 100 km. |
|                              | U. S. — 24 Miles per Gallon     |
|                              | Imp. — 28 Miles per Gallon      |
| Fuel Tank Capacity .....     | Metric — 40 Liters              |
|                              | U. S. — 10.6 Gallons            |
|                              | Imp. — 8.8 Gallons              |
| Oil Consumption .....        | Approx. .1 Liter per 100 km.    |



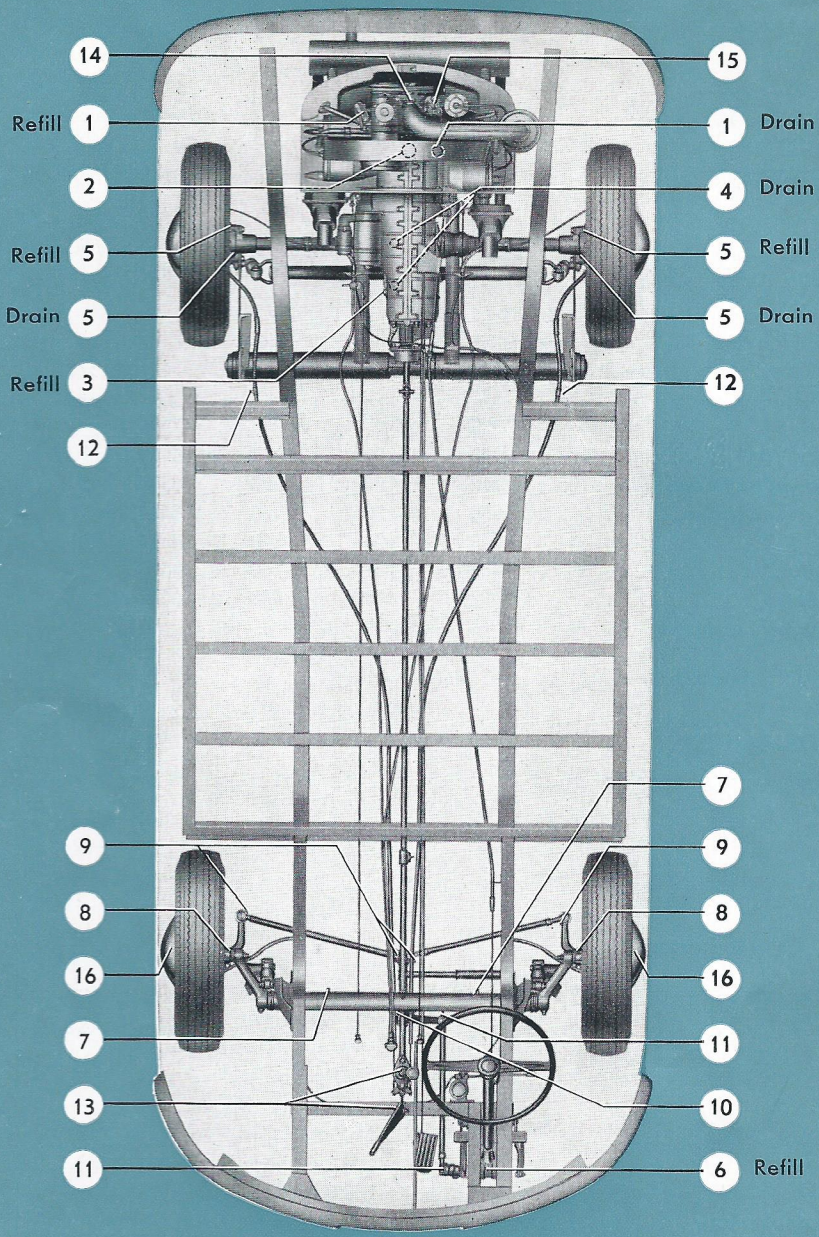



# LUBRICATION CHART

| km-Miles | At      |           | No. | Lubrication points                              | Lubricant | Every                              |
|----------|---------|-----------|-----|---|-----------|------------------------------------|
|          | 500 300 | 2000 1200 |     |   |           |                                    |
|          |         |           |     | Engine: check oil level                         | M         | <b>2000 km.<br/>1200 Miles</b>     |
|          |         |           | 7   | Front axle tubes                                | F         |                                    |
|          |         |           | 8   | King pins                                       | F         |                                    |
|          |         |           | 9   | Tie rod ends                                    | F         |                                    |
|          |         |           | 10  | Steering arms                                   | F         |                                    |
|          |         |           |     | Door hinges                                     | M         |                                    |
|          |         |           | 1   | Engine: change oil                              | M         | <b>4000 km.<br/>2400 Miles</b>     |
|          |         |           | 3   | Transmission: check oil level                   | G         |                                    |
|          |         |           | 6   | Steering gear: check oil level                  | G         |                                    |
|          |         |           | 11  | Draglink  | F         |                                    |
|          |         |           | 14  | Carburetor controls<br>Door and lid hinges      | M<br>F    |                                    |
|          |         |           | 2   | Engine: clean oil strainer                      | F         | <b>12 000 km.<br/>7 200 Miles</b>  |
|          |         |           | 13  | Gearshift and hand brake levers                 | F         |                                    |
|          |         |           | 12  | Brake cables                                    | F         |                                    |
|          |         |           | 15  | Breaker arm fiber block in ignition distributor | F         |                                    |
|          |         |           | 4   | Transmission change oil                         | G         | <b>24 000 km.<br/>14 400 Miles</b> |
|          |         |           | 5   | Reduction gear case: change oil                 | G         |                                    |
|          |         |           | 16  | Front wheel bearings                            | F         |                                    |
|          |         |           | 15  | Felt in ignition distributor cam                | M         |                                    |

# LUBRICANTS

| Lubricant   | Lubrication points   | Specifications                                      |   |           |
|---|--|---|---|-----------|
| Engine oil<br>(Trade-mark<br>HD oil for<br>Otto-cycle<br>engines) | Engine, door hinges, carburetor controls,<br>felt in ignition distributor cam  | Temperature   |   |           |
|   |  | C   | F |           |
|   |  | above +30° 86°                                      |   | SAE 30    |
|   |  | from -15° 5°  |   | SAE 20 or |
|   |  | up to +30° 86°                                      |   | SAE 20 W  |
|   |  | below -15° 5°                                       |   | SAE 10 W  |
| Transmission oil  | Transmission case, reduction gear cases,<br>steering gear case   | G SAE 90  |   |           |
| Universal grease  | Front axle, tie rod ends,<br>Front wheel bearings,<br>Brake cables, pedal bearings,<br>Gearshift and hand brake levers,<br>Ignition distributor cams,<br>Door and lid locks<br>Fiber block in ignition distributor | F<br><b>Anti-freeze,<br/>water-repellent grease</b> |   |           |



# MAINTENANCE CHART

| km.<br>500 | At   |      | Operation   | Every                                     |
|------------|------|------|---|---|
|            | 1200 | 2500 |   |   |
|            |      |      | Clean air cleaner   | <b>4 000<br/>km.<br/>2 400<br/>Miles</b>  |
|            |      |      | Check and adjust fan belt   |   |
|            |      |      | Clean carburetor<br>Check carburetor adjustment   |   |
|            |      |      | Check breaker points and ignition timing  |   |
|            |      |      | Check and adjust valve clearance  |   |
|            |      |      | Test battery  |   |
|            |      |      | Check operation of lights, signals and instruments  |   |
|            |      |      | Check generator and connections   |   |
|            |      |      | Check and set spark plugs, check compression  |   |
|            |      |      | Check front wheel bearings, torsion arm link pins, steering, and toe-in                         |   |
|            |      |      | Check tire pressure and tighten wheel bolts<br>Rotate wheels from 4000 km. (2400 miles) onwards |   |
|            |      |      | Test brakes and check brake fluid level   |   |
|            |      |      | Check tightness and effect of shock absorbers   |   |
|            |      |      | Check clutch pedal free play  |   |
|            |      |      | Check door rubber buffers and striker plates  |   |
|            |      |      | Check automatic cooling air regulation  | <b>12 000<br/>km.<br/>7 200<br/>Miles</b> |
|            |      |      | Inspect transmission and engine for oil leaks   |   |
|            |      |      | Engine, especially exhaust system, carburetor, intake manifold and fuel pump                    |   |
|            |      |      | Chassis, body, axles, steering system   | } Check tightness of nuts and bolts       |

# INDEX

|                                  | Page |                                  | Page  |
|----------------------------------|------|----------------------------------|-------|
| Accelerating — correct and wrong | 21   | Economy                          | 21    |
| Accelerator pedal                | 7    | Engine — compression ratio       | 62    |
| — accelerating                   | 21   | — description                    | 59    |
| Accessories                      | III  | — design                         | 62    |
| Ash receiver                     | 16   | — lubrication (oil change)       | 28    |
| Axle loads                       | 65   | — oil change in winter           | 26    |
| Battery — maintenance            | 51   | — oil level                      | 10    |
| — care in winter                 | 27   | — oil strainer                   | 30    |
| Body — description               | 60   | — sectional view                 | 58    |
| Brakes — adjusting               | 54   | — technical data                 | 62    |
| — application                    | 17   | — type of oil                    | 10/30 |
| — bleeding                       | 54   | Engine compartment lid           |       |
| — care in winter                 | 27   | — releasing check mechanism      | 10    |
| — checking                       | 13   | Fan belt — adjusting             | 43    |
| — description                    | 60   | — checking tension               | 11    |
| Breaking-in (running-in) period  | 20   | Foot brake — adjusting           | 54    |
| Camber of front wheels           | 64   | — description                    | 60    |
| Carburetor — adjusting           | 45   | Fresh air regulator              |       |
| — cleaning                       | 44   | — description and operation      | 18    |
| — type                           | 62   | Front axle — description         | 60    |
| Care of the car                  | 39   | — lubrication                    | 34    |
| Castor of front wheels           | 64   | — technical data                 | 64    |
| Chassis — care in winter         | 27   | Front wheel bearings — adjusting | 57    |
| Chassis number                   | 8    | — lubrication                    | 35    |
| Choke control knob               | 7    | Fuel consumption                 | 65    |
| — application                    | 14   | Fuel tank — capacity             | 11    |
| Chromium-plated parts — care     | 41   | — filler                         | 11    |
| Climbing ability                 | 65   | — reserve                        | 12    |
| Clutch — design                  | 63   | Fuel tap positions               | 12    |
| — pedal                          | 7    | Fuse box                         | 49/50 |
| — pedal free play                | 63   | Fuses — exchanging               | 49    |
| Controls — driver's              | 5    | Gear lever                       | 7     |
| Cooling of engine                | 59   | — lubrication                    | 35    |
| Dimensions — inside and outside  | 64   | Generator                        | 63    |
| Dimmer switch — headlight        | 7    | Ground clearance                 | 64    |
| Direction indicator switch       | 7    | Hand brake — adjusting           | 56    |
| Doors — lubrication points       | 36   | — description                    | 60    |
| Driving away                     | 15   | Headlights — aiming              | 53    |
| Driving down-hill                | 17   | — changing bulb                  | 54    |



|                                    | Page |                                     | Page |
|------------------------------------|------|-------------------------------------|------|
| Heating — description .....        | 60   | <b>Ratios</b> — rear axle .....     | 63   |
| — operation .....                  | 26   | — transmission .....                | 63   |
| Horn button .....                  | 7    | Rear axle — description .....       | 60   |
| Identification plate .....         | 8    | — lubrication .....                 | 32   |
| Idling — checking and adjusting .. | 45   | — reduction gears .....             | 63   |
| Ignition — breaker point gap ...   | 48   | — sectional view .....              | 61   |
| — distributor .....                | 63   | — technical data .....              | 63   |
| — firing order .....               | 63   | — transmission of power .....       | 63   |
| — timing .....                     | 49   | Rear view mirror .....              | 23   |
| Instrument panel light .....       | 13   | R.P.M. of engine — permissible ..   | 62   |
| Interior light .....               | 17   | Reverse gear .....                  | 16   |
| Jack — application .....           | 38   | Safety in traffic .....             | 23   |
| Key — doors and ignition .....     | 5    | Sectional view with explanations .. | 72   |
| License plate light                |      | Shifting gears .....                | 16   |
| — replacing bulb .....             | 51   | Shifting to reverse .....           | 16   |
| Light switch — positions .....     | 13   | Shock absorbers — design .....      | 64   |
| Lubricants .....                   | 67   | Spare wheel .....                   | 37   |
| Lubrication .....                  | 28   | Spark plug — checking and cleaning  | 47   |
| Lubrication chart .....            | 67   | — gap .....                         | 47   |
| Lubrication points .....           | 66   | Speedometer .....                   | 5    |
| Maintenance chart .....            | 68   | Speed ranges .....                  | 20   |
| Maximum performance .....          | 62   | Spots — removal .....               | 40   |
| Maximum speed .....                | 65   | Starting — danger in closed rooms   | 15   |
| Non-skid chains .....              | 27   | — in winter .....                   | 14   |
| Oil consumption .....              | 65   | — with engine cold .....            | 14   |
| Oil level — engine .....           | 10   | — with engine hot .....             | 15   |
| — steering gear .....              | 33   | Starting motor .....                | 63   |
| — transmission .....               | 33   | Steering — adjusting .....          | 57   |
| Paintwork — preservation .....     | 40   | — description .....                 | 60   |
| Parking your car .....             | 24   | — maintenance .....                 | 57   |
| Passing other cars .....           | 23   | — type .....                        | 64   |
| Polishing the paintwork .....      | 40   | Steering wheel .....                | 7    |
| Practical driving .....            | 20   | Stop light — bulb replacement ..    | 51   |
|                                    |      | — checking .....                    | 13   |
|                                    |      | Stopping the car — generally ...    | 17   |
|                                    |      | temporarily .....                   | 23   |
|                                    |      | Sunshine roof — cleaning .....      | 41   |
|                                    |      | — operation .....                   | 18   |
|                                    |      | Suspension — front .....            | 64   |
|                                    |      | rear .....                          | 64   |

|                                  | Page |                               | Page  |
|----------------------------------|------|-------------------------------|-------|
| Technical data .....             | 62   | Valves — adjusting .....      | 46    |
| Tires — inflation pressure ..... | 13   | — arrangement .....           | 62    |
| — maintenance .....              | 37   | — clearance .....             | 46/62 |
| — M + S .....                    | 27   | Vent wing .....               | 7     |
| — size .....                     | 64   | Warning lights                |       |
| — wear .....                     | 37   | — direction indicator .....   | 5/22  |
| Toe-in of front wheels .....     | 64   | — generator and cooling ...   | 5/22  |
| Tools and accessories .....      | III  | — headlight .....             | 5/22  |
| Track (tread) .....              | 64   | — oil pressure .....          | 5/22  |
| Transmission — description ..... | 60   | — replacing bulbs .....       | 51    |
| — oil change and                 |      | Washing your car .....        | 39    |
| capacity .....                   | 32   | Weights .....                 | 65    |
| — sectional view ..              | 61   | Wheel base .....              | 64    |
| — technical data ..              | 63   | Wheels — balancing .....      | 38    |
| Turning circle .....             | 64   | — changing .....              | 38    |
| Type of fuel .....               | 30   | — rim size .....              | 64    |
| Upholstery — care .....          | 41   | Windshield — cleaning .....   | 41    |
|                                  |      | Windshield wiper switch ..... | 7     |
|                                  |      | Winter service .....          | 25    |

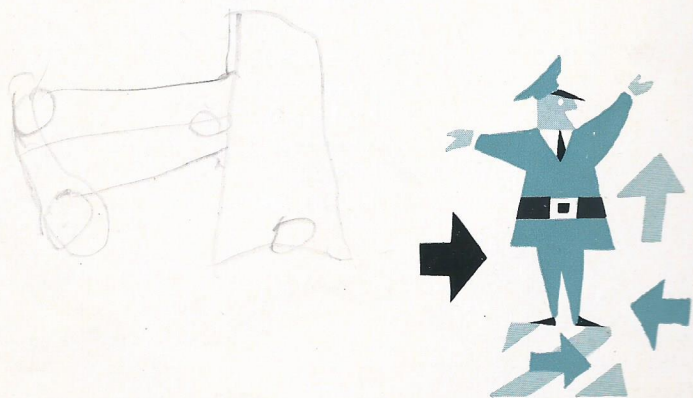



## **VW Transporter, Sectioned**

- 1 - Steering gear
- 2 - Pedals
- 3 - Hand brake lever
- 4 - Brake master cylinder
- 5 - Gear lever
- 6 - Front axle
- 7 - Front shock absorber
- 8 - Spare wheel
- 9 - Jack socket
- 10 - Fresh air regulator
- 11 - Heated air duct
- 12 - Side member
- 13 - Torsion bar seat
- 14 - Fuel tank
- 15 - Transmission
- 16 - Rear shock absorber
- 17 - Reduction gears
- 18 - Air cleaner
- 19 - Carburetor
- 20 - Distributor
- 21 - Fuel pump
- 22 - Generator
- 23 - Battery
- 24 - Muffler (Silencer)

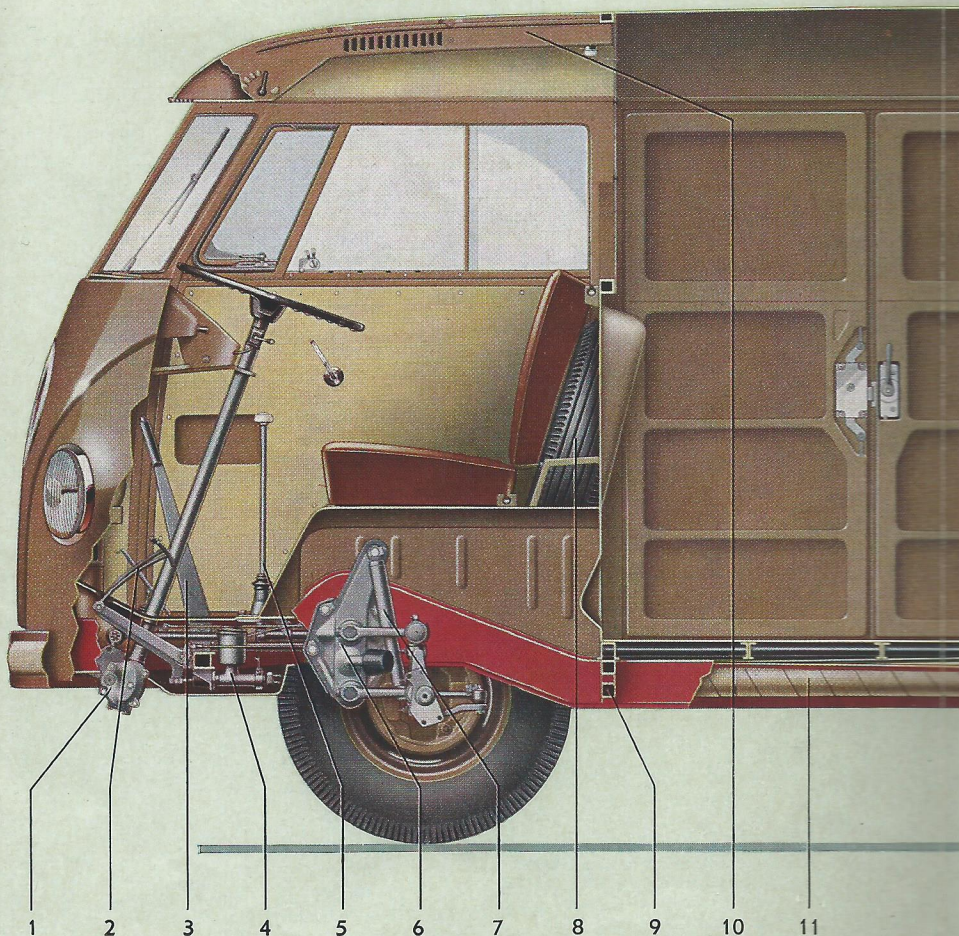



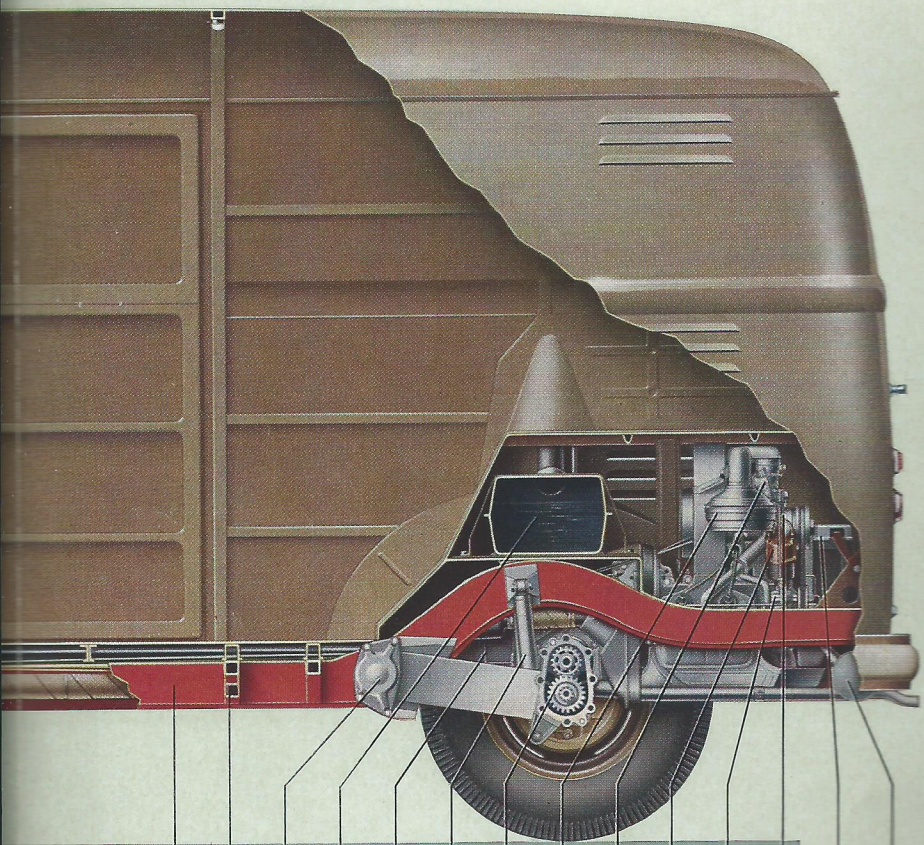

- 12 9 13 14 15 16 17 18 19 20 21 22 23 24

## **Tools and Accessories**

- 1 Fan Belt
- 1 Tool Bag
- 1 Starting Handle
- 1 Spare Wheel, complete
- 1 Jack
- 1 Square Key
- 1 Combination Pliers
- 1 Screw Driver 0.8 mm.
- 1 Screw Driver 0.5 mm.
- 1 Box Wrench 36 mm.
- 1 Socket Wrench 14 mm.
- 1 Socket Wrench for Spark Plug, Wheel Bolt and Jack
- 1 Open End Wrench 8/12 mm.
- 1 Tommy Bar (Mandrel) for Socket Wrench

The VOLKSWAGENWERK GMBH reserves the right to make any changes in or improvements on its products without imposing any liability or obligation upon itself to install them on its products previously manufactured.

All rights reserved in accordance with the law of copyright.



