

Instruction Manual

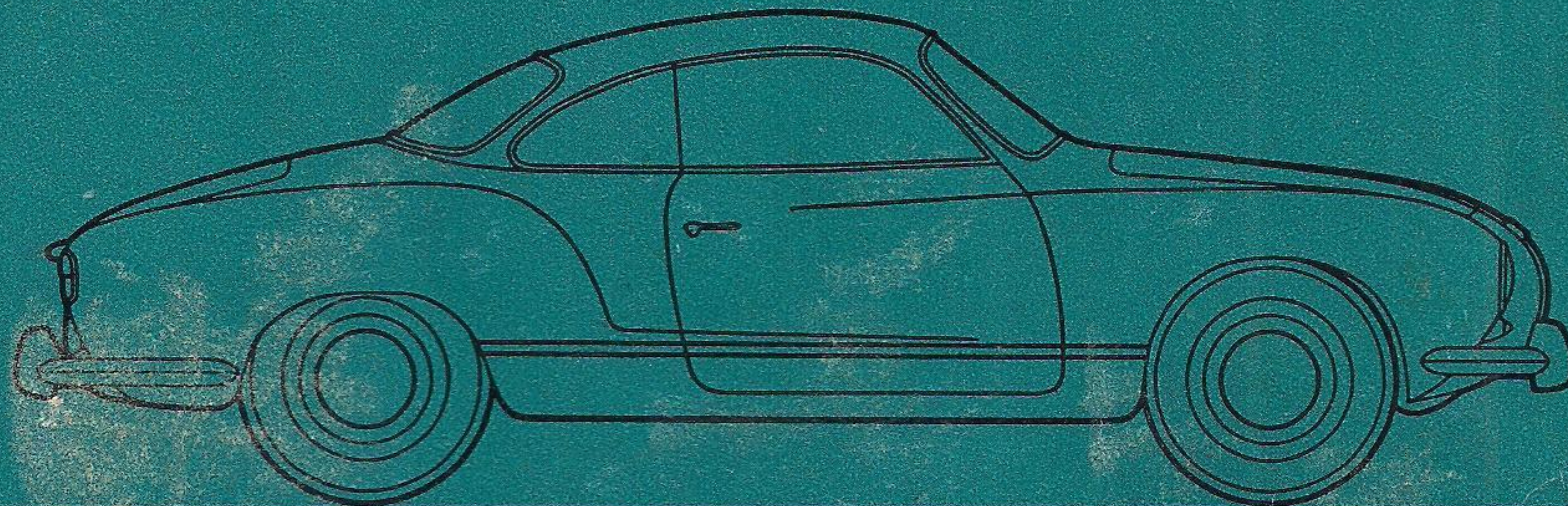

463-E



CAUTION
DO NOT OVERFILL BATTERY
 Proper Liquid Level Is 1/2 Inch Above Plates
 Overfilling May Result In Acid
 Damage To Floor Trim.

January 1957

NORTH IMPORT MOTORS, Inc.
 3638 - 42 N. SOUTHPORT
 CHICAGO 13, ILLINOIS
 WE. 5-2200

INSTRUCTION MANUAL

CAUTION
DO NOT OVERFILL BATTERY
 Proper Liquid Level Is 1/2 Inch Above Plates
 Overfilling May Result In Acid
 Damage To Floor Trim.

CONTENTS

Introduction	3
Controls and Instruments	5
Operating Instructions	7
Practical Driving	18
Cold Weather Hints	23
Lubrication	26
Wheels and Tires	34
Care of the Car	36
Maintenance	41
General Description	57
Technical Data	61
Lubrication Chart	65
Maintenance Chart	66
Index	67

We are sure that the excellent performance and economical operation of your Coupé will justify the confidence you have placed in our firm when purchasing this car.

This Manual sets out in full the information necessary for the proper operation, care and general maintenance of your car. In addition, interesting specification details have been included to familiarize you with the construction and mechanical details of this fine piece of mechanism.

No effort has been spared to produce an efficient and reliable automobile. This Instruction Manual can help you obtain long time satisfaction in the operation of your Coupé. All information contained in this handbook is based on the actual experience of many years.

In order to maintain maximum efficiency, we particularly stress the importance of following the recommendations set out in this manual. The intimate knowledge obtained by studying this manual will assure you of the utmost service and satisfaction from your Karmann-Ghia Coupé.

Regular attention to proper lubrication and maintenance of your car is important. An extensive network of VW Dealers exists throughout the world, and you will readily recognize such stations by the familiar blue VW SERVICE sign. These Dealers are in constant contact with the Volkswagenwerk through our field engineers, thus providing skillful and factory-efficiency on any job from a tire change to a complete overhaul. You'll enjoy many more miles of trouble-free driving by giving your Coupé just ordinary care.

All experienced car owners know the value of preventive maintenance. The efforts in regard to care and maintenance will be amply rewarded in the long run.

And now enjoy your COUPE!

CONTROLS AND INSTRUMENTS

The first thing you must do is become familiar with the controls and instruments of your new car. Sit behind the wheel, make yourself comfortable, and get acquainted with all the various levers, switches, and controls. Some of the features you may already know. Check your present knowledge against this complete list.

Instruments:

Speedometer and odometer	8
Warning light — Blue — Headlight high beam	6
Warning light — Red — Generator and cooling system	5
Warning light — Green — Low oil pressure	9
Warning light — Red — Direction indicators	7
Clock (electrically driven)	11

Foot controls:

Headlight dimmer switch	19
Accelerator pedal	22
Brake pedal	21
Clutch pedal	20

Hand controls:

Inside door handle	16
Headlight and instrument light switch	14
Windshield wiper switch	13
Choke control	4
Clock reset knob	12
Combined ignition and starting switch	3
Fresh-air ventilator control	1
Gear lever	24
Fuel tap	23
Hand brake lever	26
Heating control	25
Window regulator handle	15
Front hood lock control	18
Direction indicator lever	2
Horn button	10
Steering wheel	17

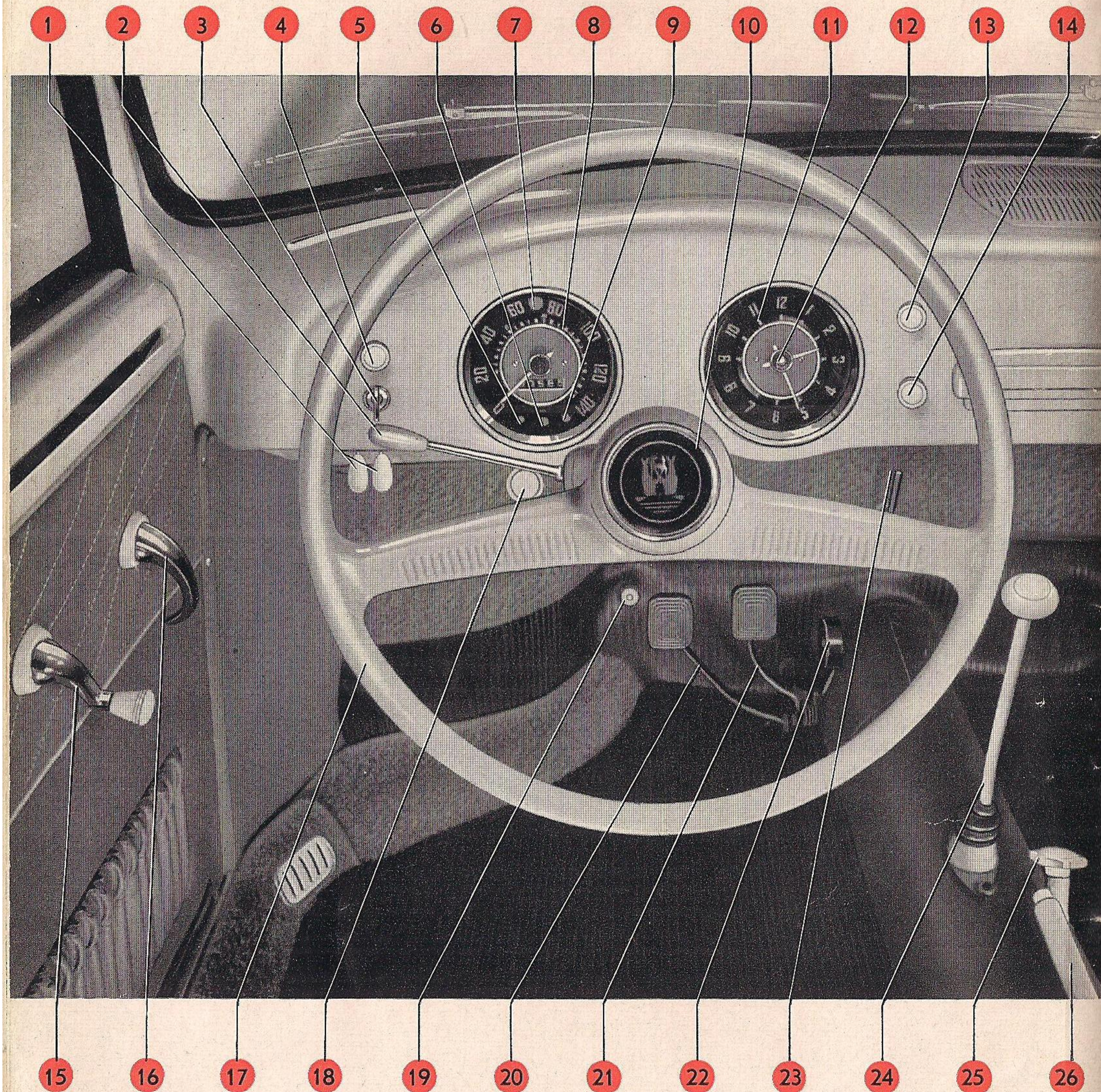

Among the papers which accompany your car you will find details regarding the model, year of construction, and chassis and engine numbers. The Police or Traffic Department will check, if the information given in the documents is identical with that on your car.

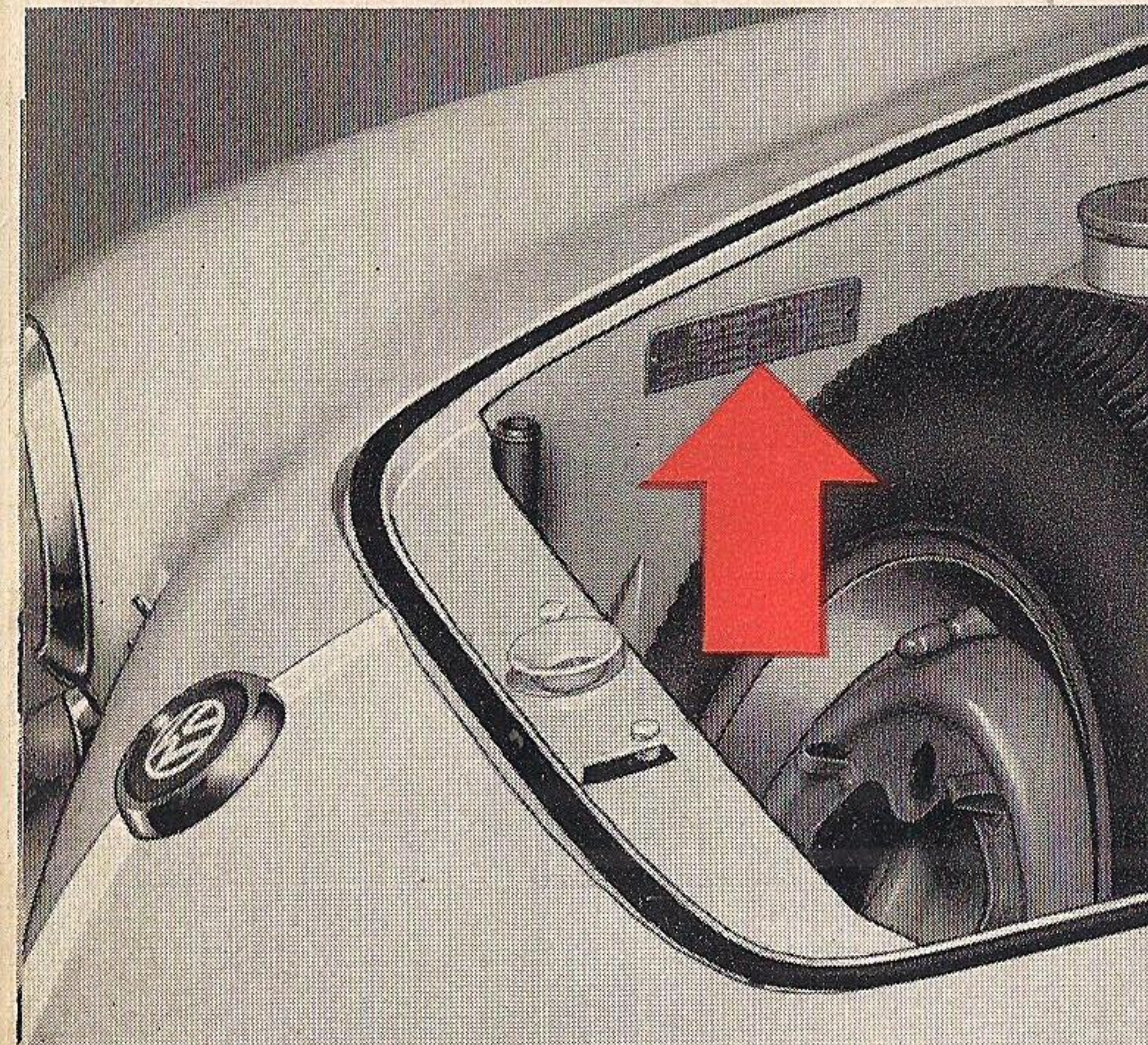

The Identification Plate

is found to the right of the spare wheel underneath the front hood.

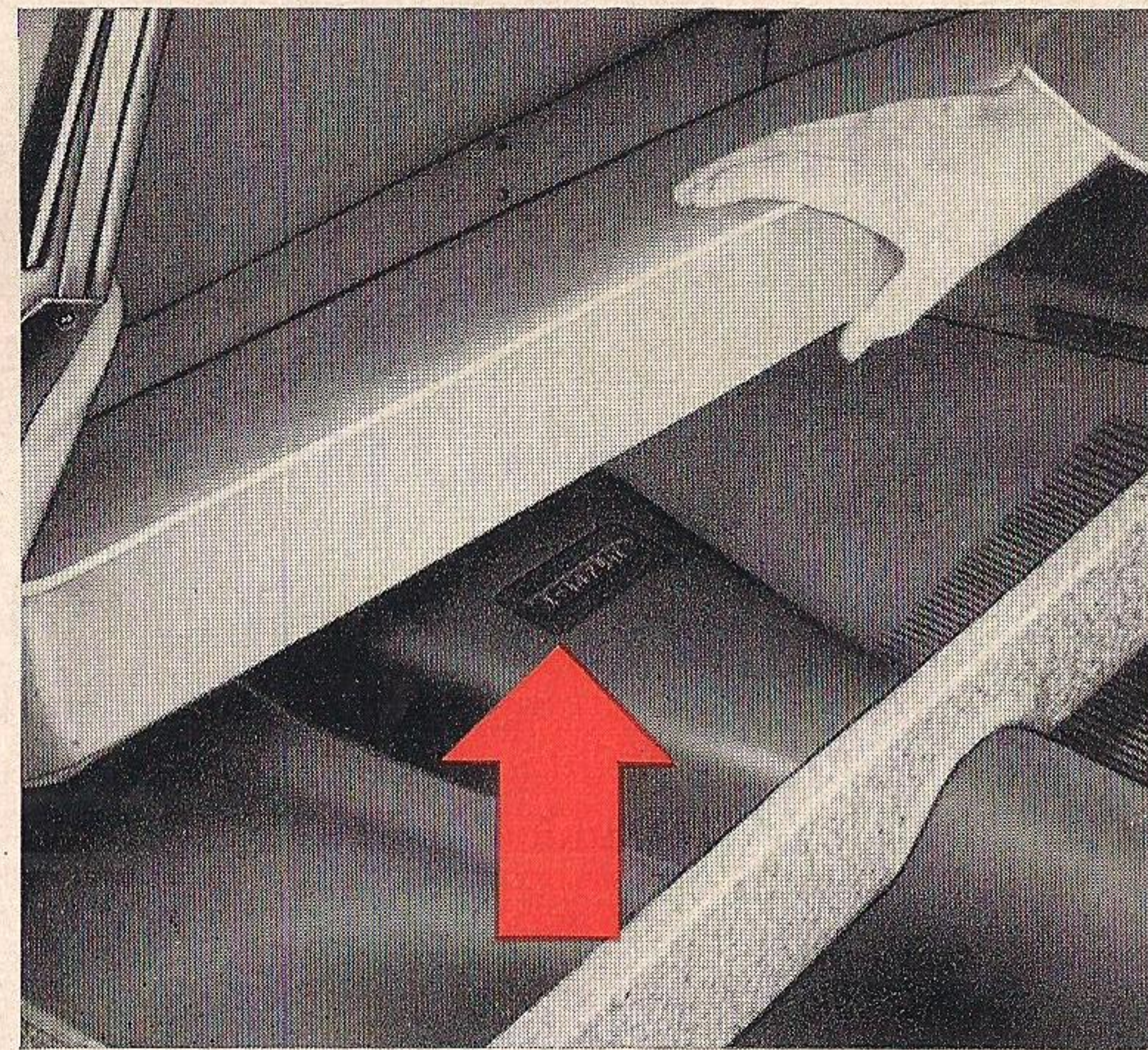

The Chassis Number

is stamped on the frame tunnel underneath the emergency seats.

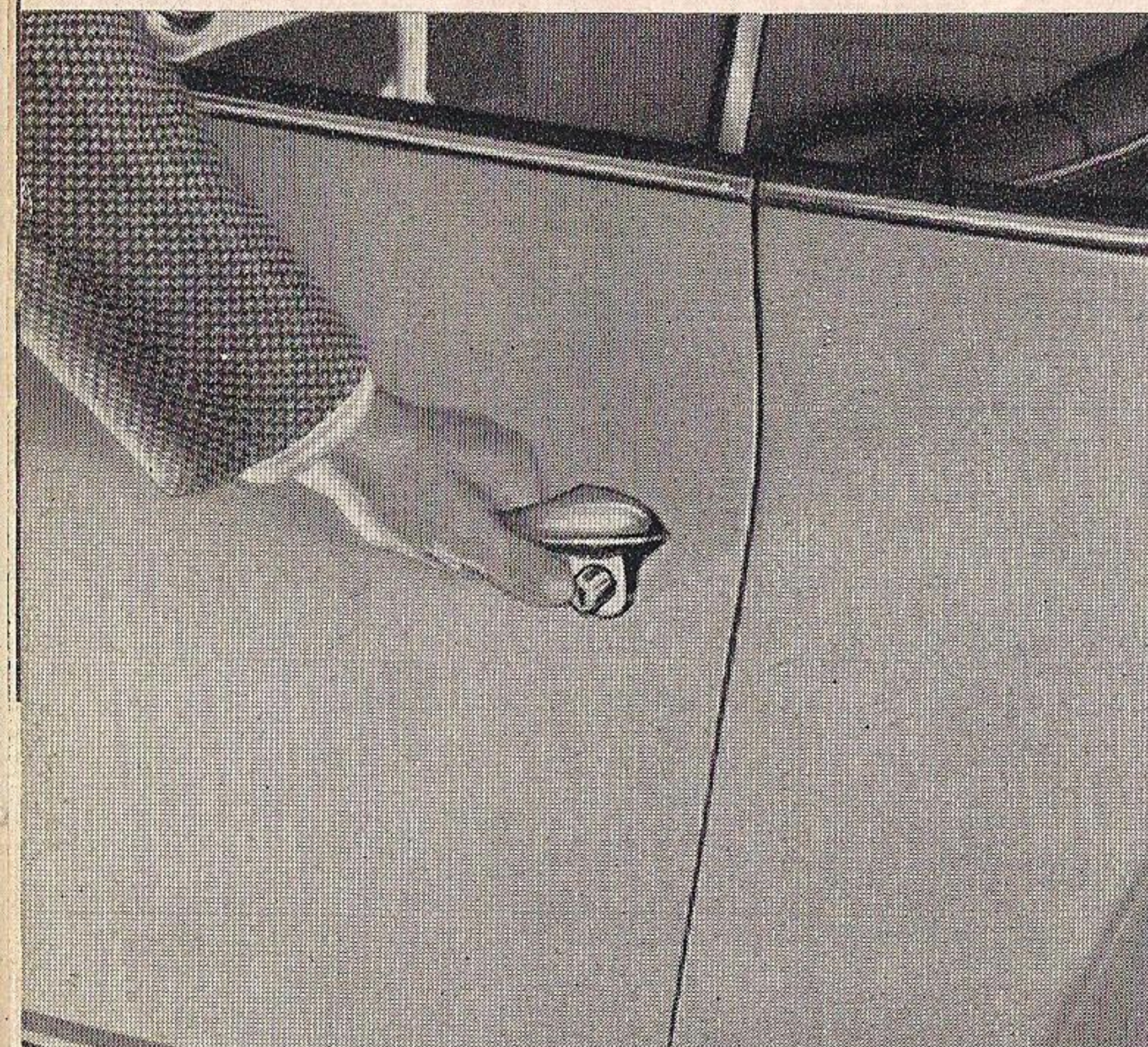

The Engine Number

is stamped on the generator support.

Only one key

is required to unlock the door, turn on the ignition, and operate the starting motor. It is advisable to record the key number, so that you can order duplicates from your dealer, should you lose or misplace your keys.

To open the door, press the button in the handle.

OPERATING INSTRUCTIONS

Before you drive away please check

▶ engine oil level

▶ fan belt tension

▶ quantity of fuel in the tank

▶ tire pressures

▶ efficiency of brakes

and, if driving at night,

▶ the exterior lights

Engine Oil Level

The oil level should be checked with the engine at rest. The oil level is satisfactory when it is between the two marks on the oil level dipstick, but **it should never be permitted to drop below the lower mark.** To make an accurate check, it is best to wipe the dipstick with a clean rag before.

Should it become necessary to add oil please remember the following hints: Most oils marketed at present contain chemical ingredients to improve their lubricating qualities. However, oils of different origin behave differently when used as engine lubricants and should, therefore, not be mixed.

Select a HD oil (for Service MS) from well-known and dependable brands right at the beginning, and stick to it!

It would be wrong to fill in HD oil and Regular oil at random, or even to mix these two types!

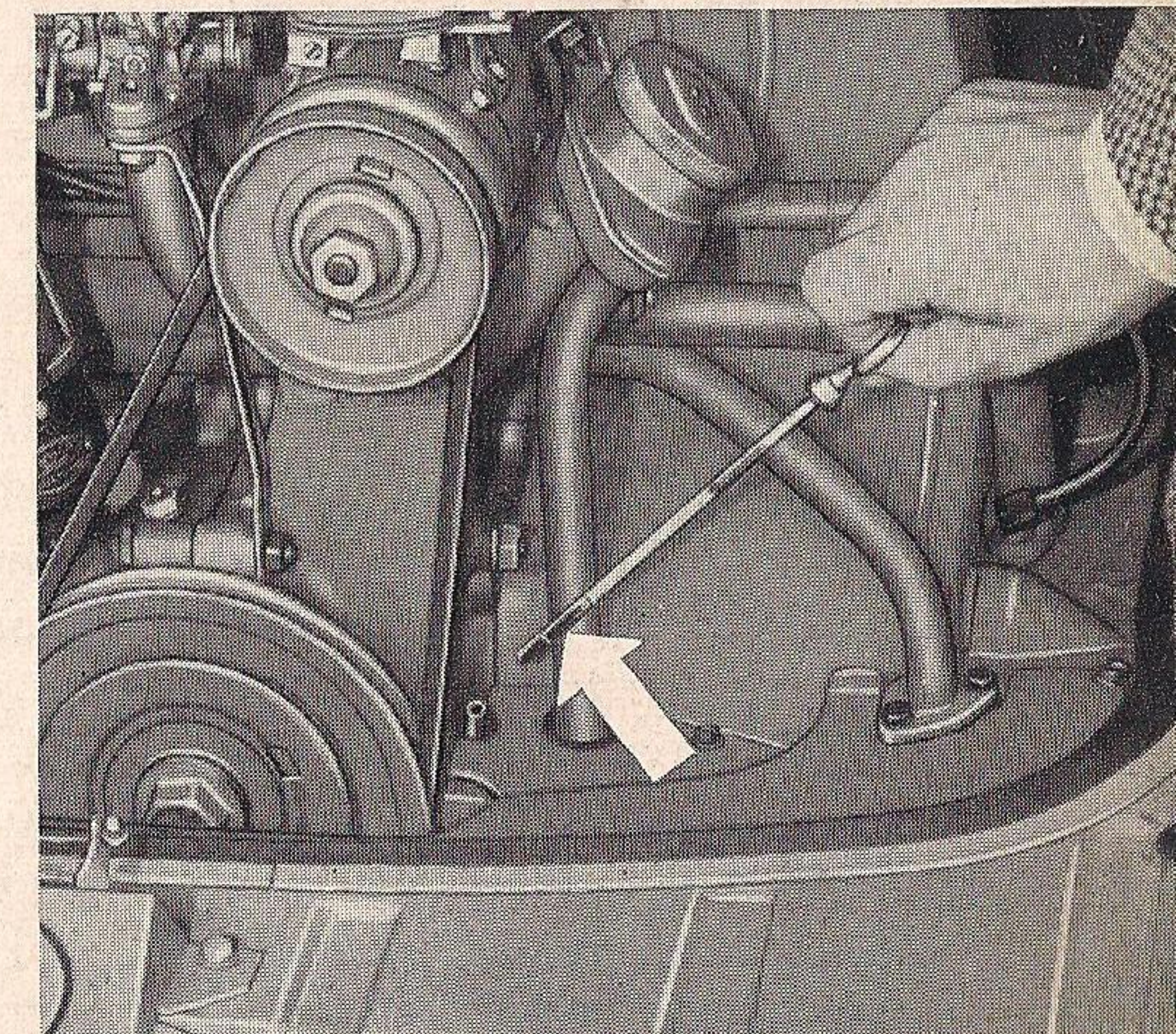

Fan Belt

The V-belt drives the generator and the fan. Perfect condition and correct tension of the belt insure its long life and adequate cooling of the engine. Checking is very simple: The belt, when pressed with the thumb at mid-point, should yield approximately 15 mm (.6"). If you find any sign of wear, such as frayed edges, see your VW Dealer.

a = 15 mm (.6")

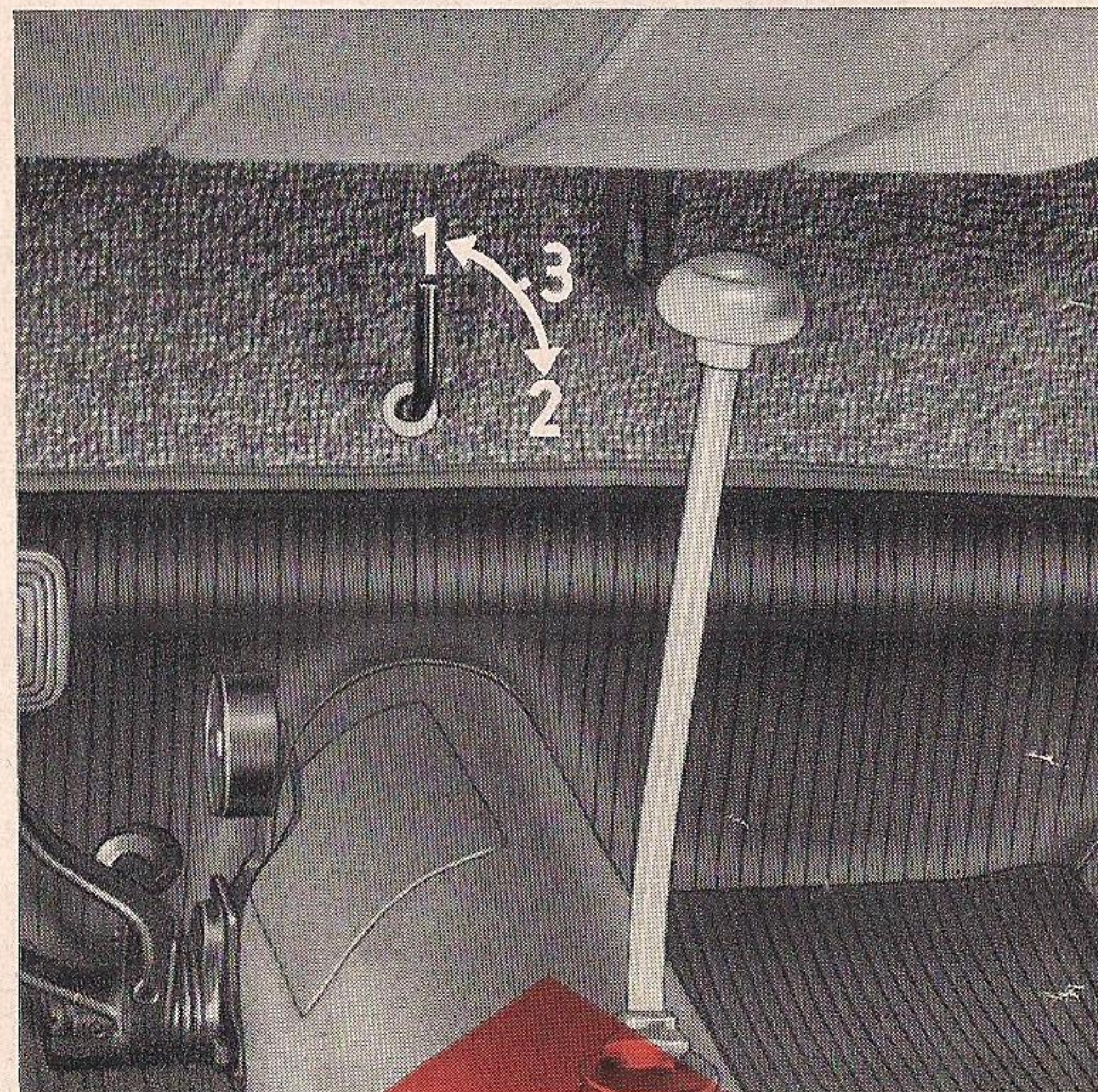
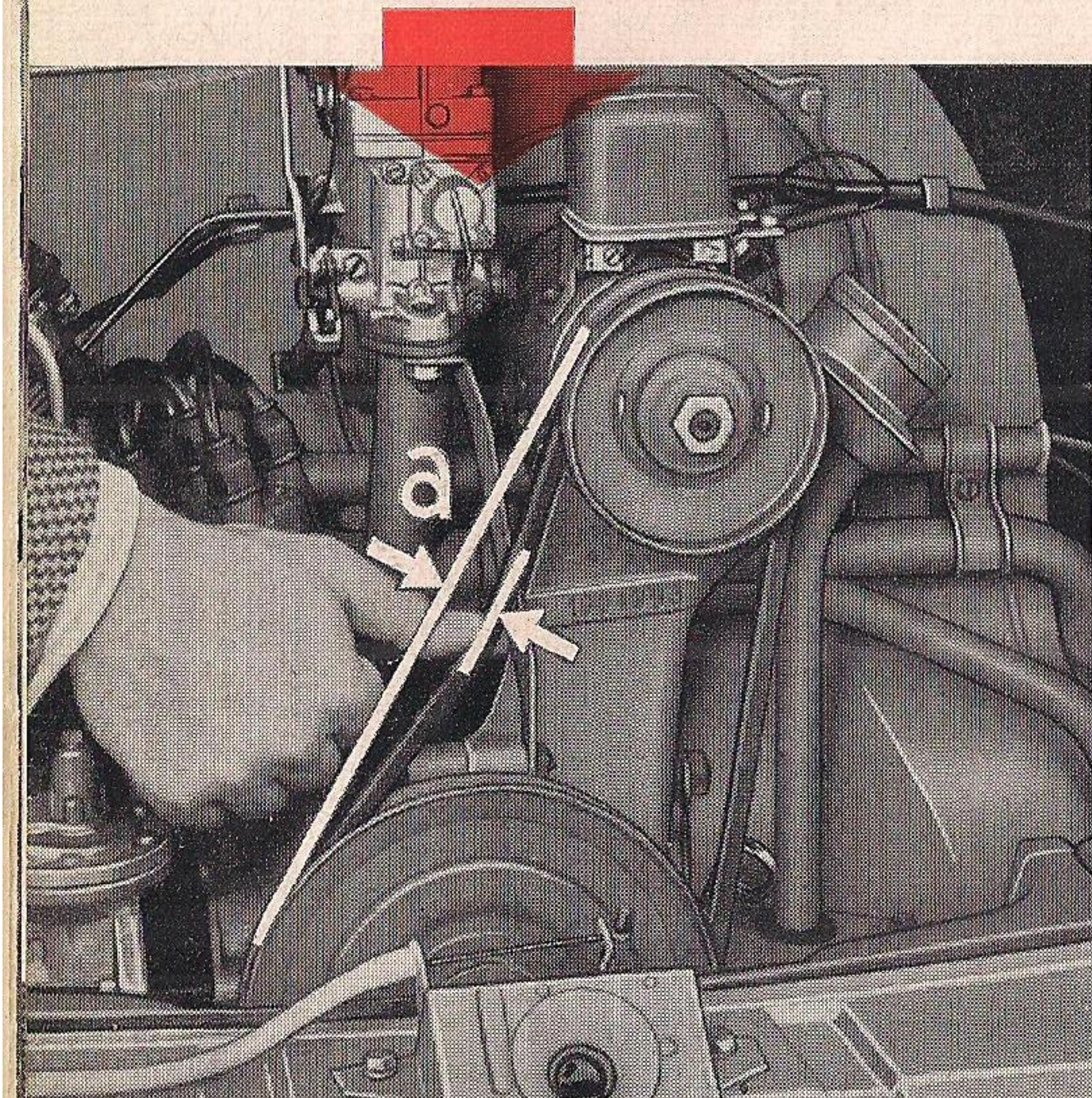

Positions of fuel tap: 1 - Open, 2 - Reserve, 3 - Shut off.

Fuel Tank

The tank has a capacity of 40 liters (10.5 U.S. gall., 8.8 Imp. gall.), sufficient for a drive of well over 500 kilometers (300 miles). Under normal conditions, the fuel tap should be set at position "1", while the car is in operation. If the engine begins to "stutter", as a result of lack of fuel, just turn the tap to "2". A fuel reserve of 5 liters (1.3 US. gall., 1.1 Imp. gall.) will then last for a further drive of about 70 kilometers (45 miles). It is important to re-set the tap at position "1" when refilling the tank, otherwise there will be danger of running out of fuel on the road. The fuel supply is shut off when the lever is set half way (45°) between the two end positions.

The design of the VW Engine allows an operation on all proven trade-mark fuels. Trade-mark fuels, including gasoline-benzol blends, comprise such characteristics as constant physical properties, sufficient anti-knock qualities and freedom from objectionable constituents.

The selection of a grade and brand of fuel is therefore left entirely to your discretion.

The Tires

deserve and require your special attention. The riding comfort and the road-holding of your car will greatly depend on their condition.

Maintaining correct tire pressure and avoiding driving abuses are the most important factors in obtaining maximum tire life. Make sure the tires are correctly inflated, at least once a week, using a reliable tire gauge.

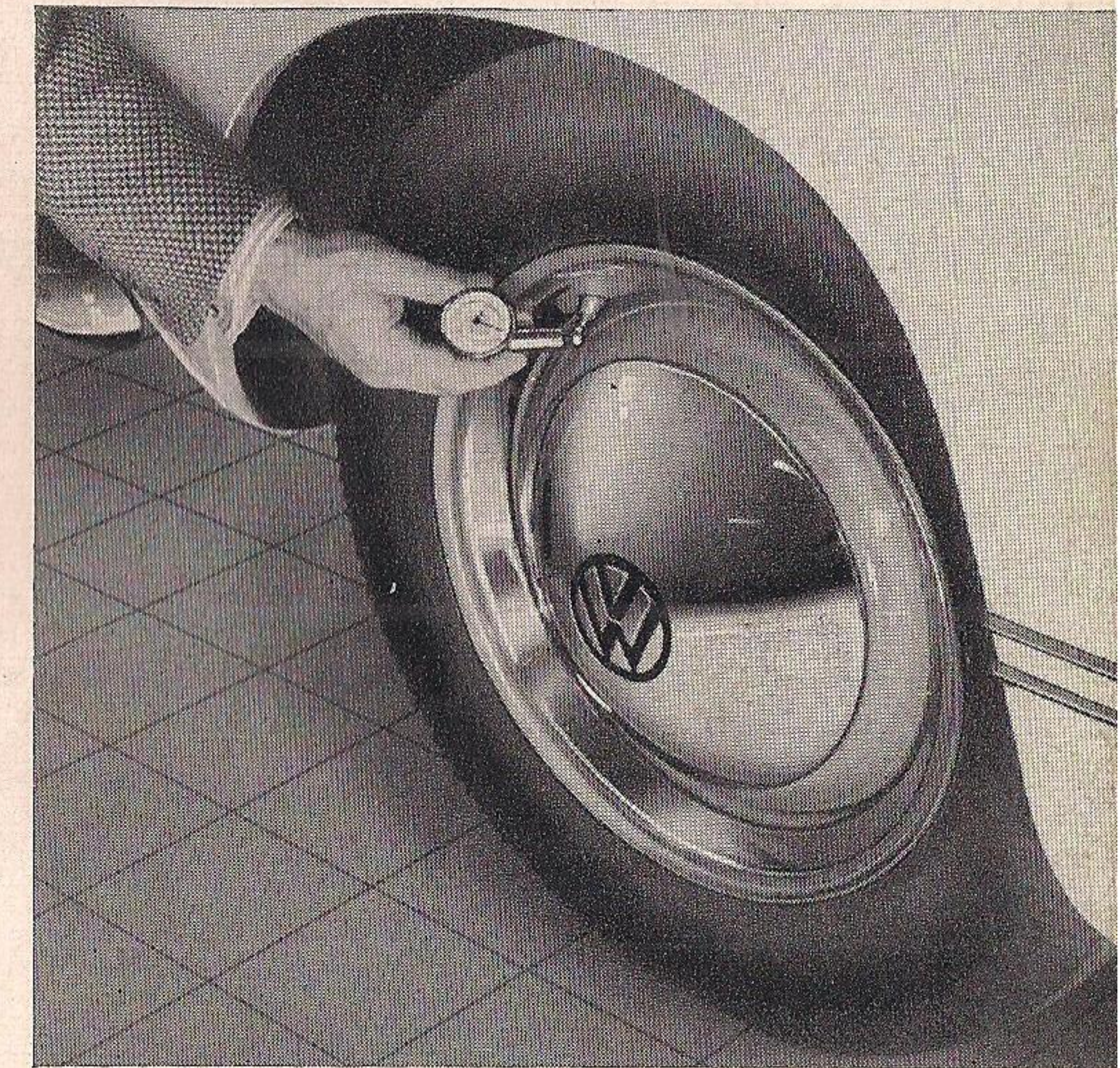

Keep the pressures between 1.1 and 1.2 kg./sq. cm. (16 and 17 lbs./sq. in.) in the front tires, between 1.4 and 1.6 kg./sq. cm (20 and 23 lbs./sq. in.) in the rear tires. When the car is fully loaded, or when driving fast for a long period of time, keep to the higher tire pressures.

The Brakes

should be checked before the car starts on a trip by gradually depressing the brake pedal, while the car is in motion, to be sure they are in good working order.

Good Exterior Lights

are the first requirement of safe car operation at night. The three positions of the lighting switch are as follows:

- 1 - Fully pushed in — Off
- 2 - Pulled out to first stop — Parking light,
tail and license plate lights
- 3 - Fully pulled out — Headlight high or low beams
(depending on position of foot dimmer switch),
tail and license plate lights.

When pulling out the lighting switch knob either to the first or second stop, the instrument light is automatically turned on. By turning the knob, a variable degree of instrument lighting is obtained, turning the knob to extreme left turns out the light entirely. When checking the lighting system, do not forget the two stop lights which should light up when depressing the brake pedal with the ignition turned on.

Starting the Engine

is easy, because you are now familiar with the various controls and instruments. However, make sure that the gear lever is in neutral position before starting the engine.

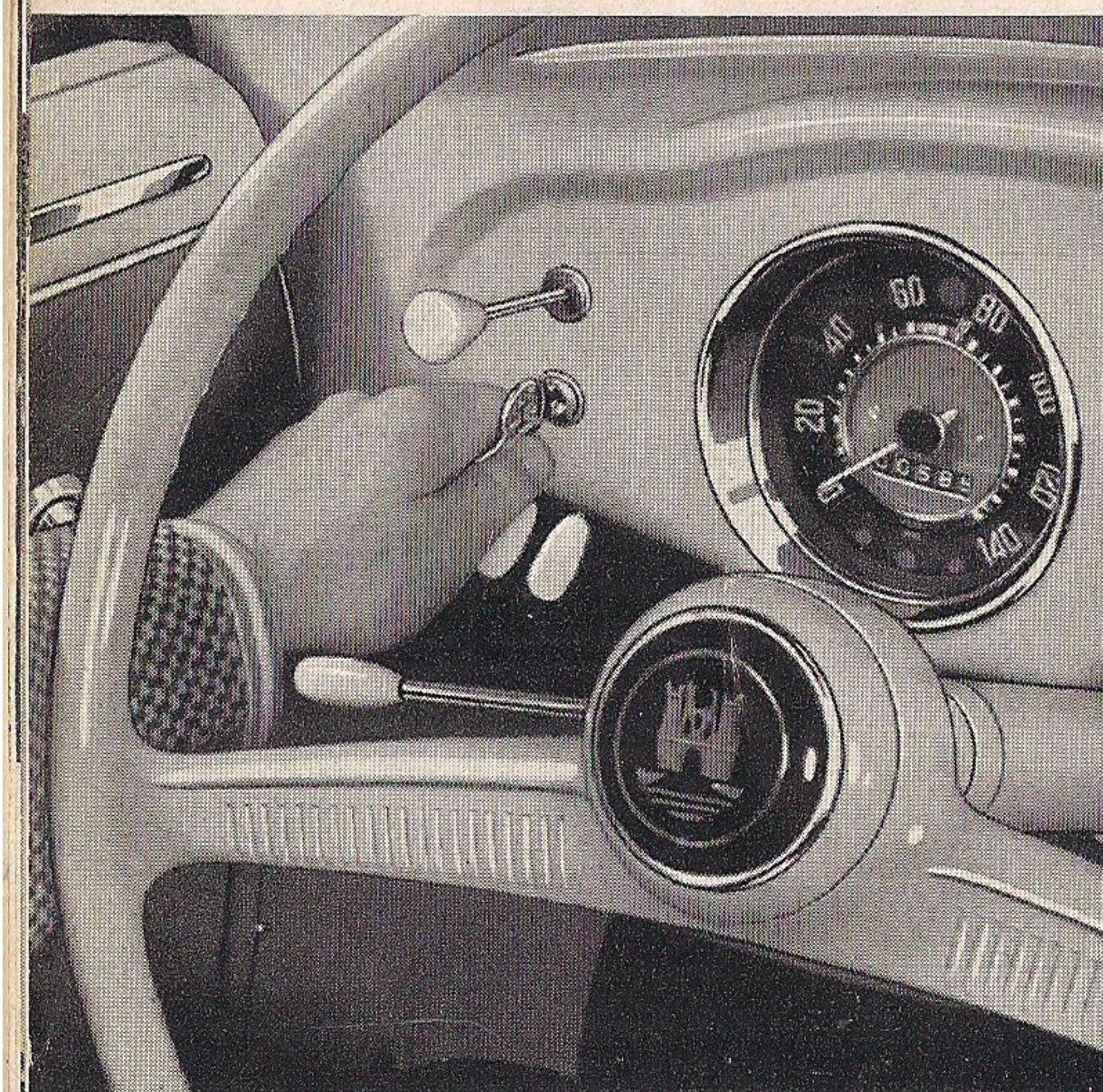

The ignition key starting enables you to start the engine by merely turning the key. First the ignition is switched on by turning the key to the right. The red generator warning light and the green light for the oil pressure will light up. To start the engine, the key is pressed against a spring load and further turned clockwise until the starting motor operates. As soon as the engine fires, release pressure on key to disconnect starting motor.

Important

In cold weather the transmission oil is apt to become congealed. It is, therefore, good practice to declutch until the engine starts. Thus you will save the battery and facilitate the operation of the starting motor. You will never encounter any difficulties when starting your engine in the coldest weather, if you observe the rule of using the specified light grade engine and transmission oils.

To start cold engine,

pull out the choke control knob and operate the starting motor until the engine starts.

In severe frost, it is recommended to proceed as follows:

- 1 - Slightly depress the accelerator pedal several times.
- 2 - Fully pull out the choke control knob.
- 3 - Fully depress clutch pedal.
- 4 - Turn on the ignition and operate the starting motor.

As soon as the engine starts, slowly push in choke control knob (about half way) until the engine runs smoothly and evenly at fast idle speed without a tendency to stall (it is inadvisable to race the engine immediately on starting up from cold).

This position of the choke control knob permits a quick moving off without any detriment to the engine. Neither will harm be done to the engine when you drive for a longer period in dense city traffic with the choke pulled out half way.

As the engine attains operating temperature, you will notice an increase in the idling speed. At the same time gradually push the choke control knob all the way in.

This position must be reached before you make use of the full engine power on a free road. If the engine does not start within ten seconds, just repeat the procedure a few times, allowing a short interval between each successive attempt, as the battery is being strained heavily by continuous starting motor operation.

To start warm engine,

do not pull the choke control knob.

Slowly depress accelerator pedal while letting the starting motor operate. Do not pump the accelerator pedal.

It is important to know that pumping the accelerator pedal makes a starting of the warm engine difficult and increases the fuel consumption.

Caution!

Be careful when starting the engine inside your garage. See to it that the door and windows are open so that the exhaust fumes can escape. They contain the colorless, tasteless and odorless, yet extremely poisonous carbon monoxide gas.

Driving Off

is extremely easy, if you observe the following:

- 1 - Press down the clutch pedal as far as possible. Keep it in that position.
- 2 - Shift to the first gear. Release the hand brake.
- 3 - Engage the clutch by gently removing your foot from the pedal, while simultaneously pressing down the accelerator pedal. The car will start to move ahead.
- 4 - Gradually increase the pressure on the accelerator pedal and remove your foot completely from the clutch pedal, as the clutch is now fully engaged.

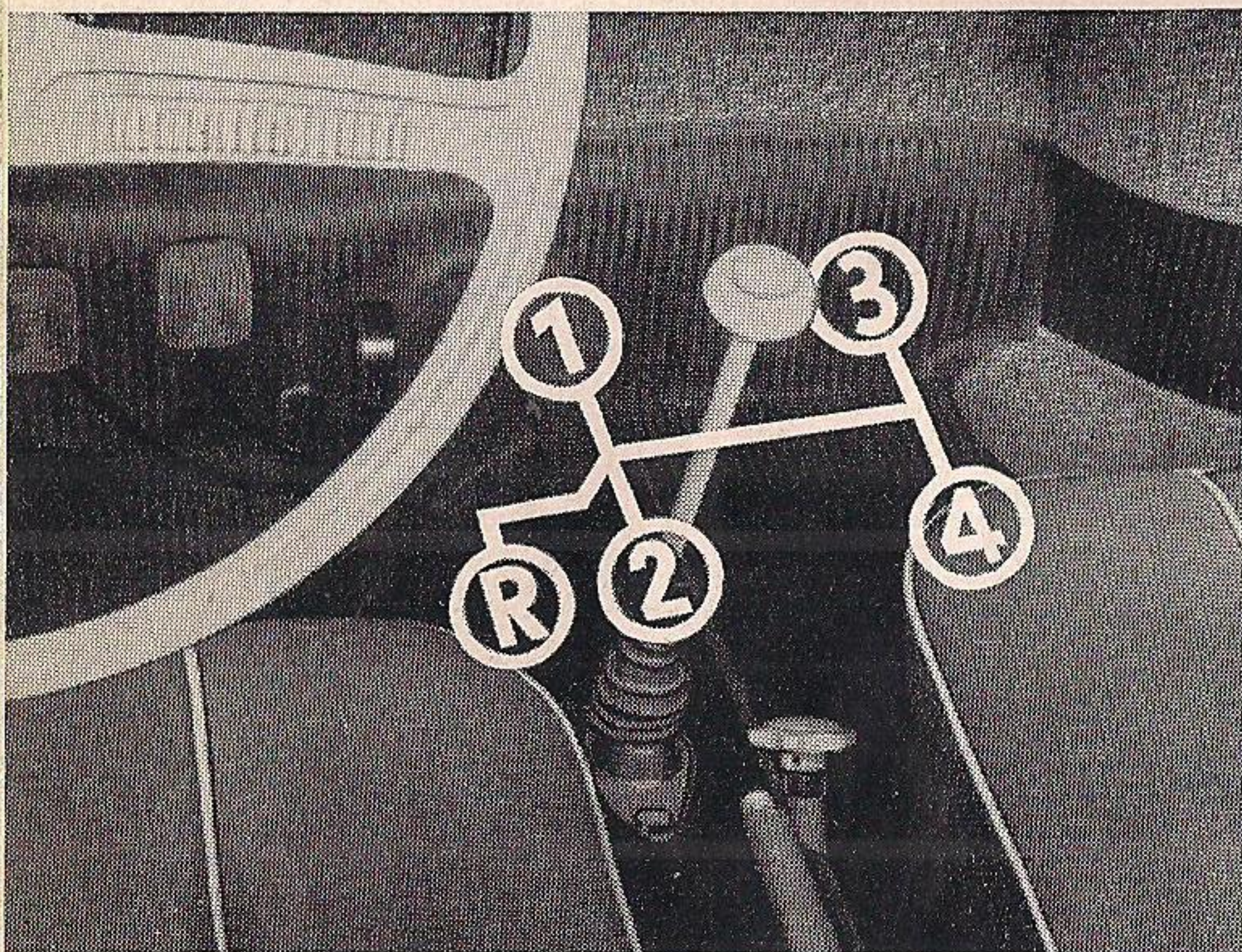

Shifting to second gear is equally simple:

- 1 - Take your foot off the accelerator pedal, while simultaneously pressing down the clutch pedal.
- 2 - Shift gear lever into second position.
- 3 - Engage the clutch by taking your foot off the pedal gently and gradually and again step on the accelerator pedal.

You now know how to "shift gears", and may at will shift to third and fourth positions. You will have noticed by now that the accelerator and clutch pedals are operated simultaneously, but in opposite directions. It is the coordination of these simultaneous operations that brings skill in shifting gears.

To engage the reverse gear, first press down the gear lever vertically, move it to the left and pull it rearward.

Shifting to Lower Gear

This is what you should do in close city traffic, or with sharp turns ahead of you, or when driving uphill.

- 1 - Release accelerator pedal and depress clutch pedal.
- 2 - Shift to 3rd or 2nd gear respectively.
- 3 - Release clutch pedal and step on accelerator pedal simultaneously.

Of course, this goes much more quickly in actual operation than by describing it here. We do not want to bore you with a technical discourse, but it may be

of interest to you to know that, when changing down, the synchromesh device assures meshing of the gears without clash, as the lower gear is synchronized so that both gears are turning at the same speed.

When shifting gears, it is absolutely necessary to fully depress the clutch pedal. Incomplete declutching makes gear shifting difficult and leads to rapid wear of the synchronizer stop rings.

The first gear is not provided with a synchronizing device, as the main drive shaft normally is not turning when the car is shifted into first.

Should it become necessary to shift from second to first, the two cogwheels of the lower gear should be brought to the same ratio of speed by momentarily depressing the accelerator pedal with the gear lever in neutral position to insure an easy and silent engaging of the gears. This is done as follows:

- 1 - Release accelerator pedal and depress clutch pedal.
- 2 - Place gear lever in neutral position.
- 3 - Release clutch pedal and depress accelerator pedal at the same time, the amount of this intermediate feeding of gas depends on the speed of the car.
- 4 - Depress clutch pedal and shift to first gear.
- 5 - Release clutch pedal steadily and at the same time step on accelerator pedal.

Under no circumstances should you be afraid to shift to lower gear, or try to avoid shifting occasionally by merely letting the clutch "slip" in a partly disengaged position. Do not use clutch pedal as a foot-rest while driving your car.

Wait until the car is at a dead stop before engaging reverse.

Brakes

The brakes should be applied sparingly. The inexperienced driver can be recognized by the too frequent lighting-up of the stop light. By removing your foot from the accelerator pedal, the engine compression will serve as a brake, thus saving fuel and preventing premature wearing of tires and brakes. Don't drive too fast and then skid to a stop, but drive at a moderate speed, commensurate with the traffic, and your car will perform most economically. To jam on the brakes suddenly can only be justified when danger is ahead.

Operate your brakes especially gently when the road is wet or covered with ice. Sudden braking of the wheels will result in skidding of the car. Here is one of the fundamental rules:

Use your brakes before, not while making a turn!

When driving downhill, make use of the braking capacity of the engine compression by shifting to that gear which you would use in driving uphill. You will save and preserve the brakes if you use them only to control the speed occasionally, and at the same time you will attain a higher degree of safety. The ignition must never be switched off when descending grades.

Stopping the Car

Take your foot off the accelerator pedal and operate the brakes gently. Shortly before the car comes to a full stop, depress the clutch pedal, place the gearshift lever in neutral position and release clutch pedal again. The engine continues to idle. If you wish to turn off the engine, merely switch the ignition key to the left.

The Front Seats

allow an adjustment to suit individual requirements. Merely raise the adjusting lever and slide the seat either backward or forward to the most convenient position. The seat rises as it moves forward, permitting short persons to sit higher.

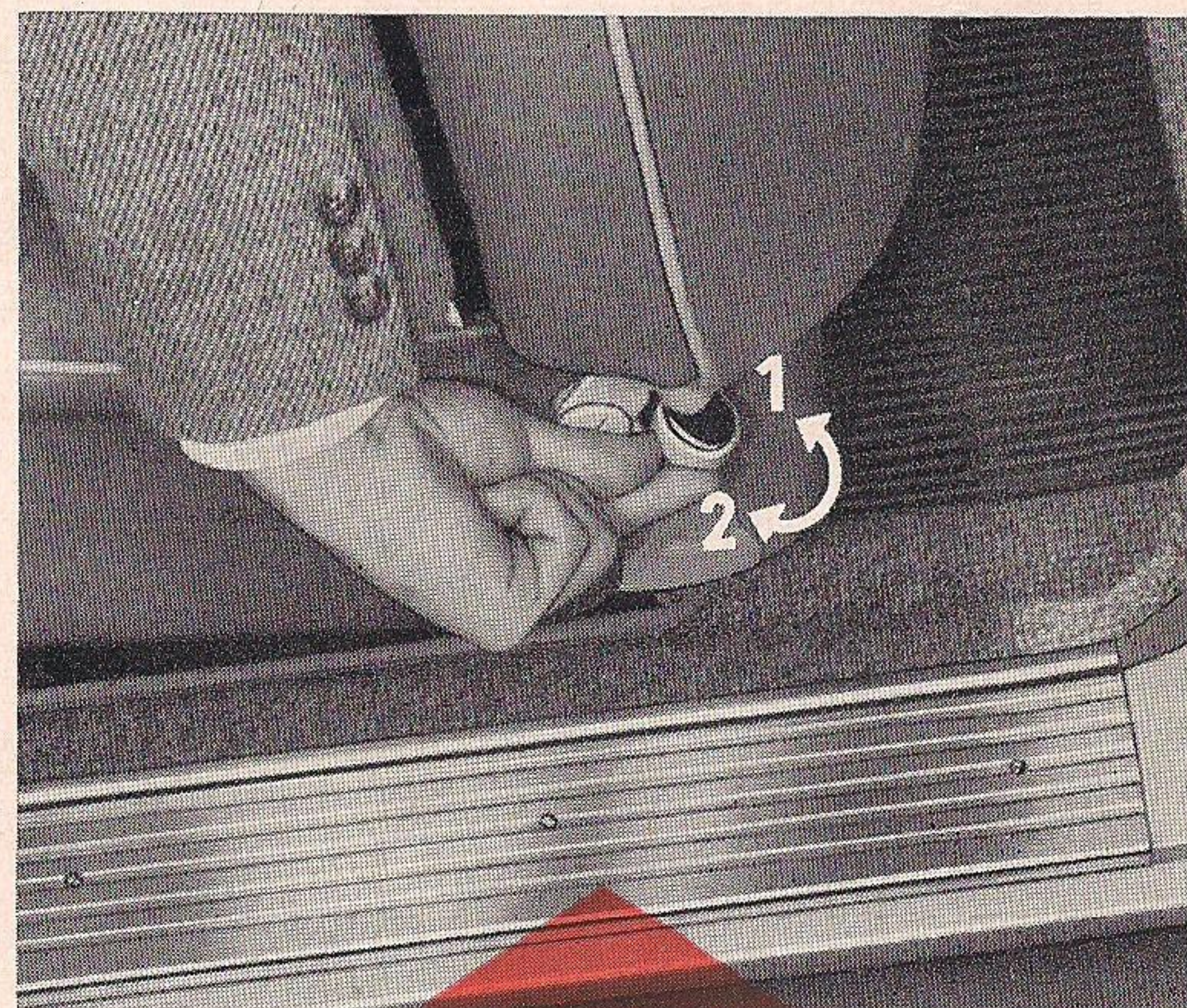
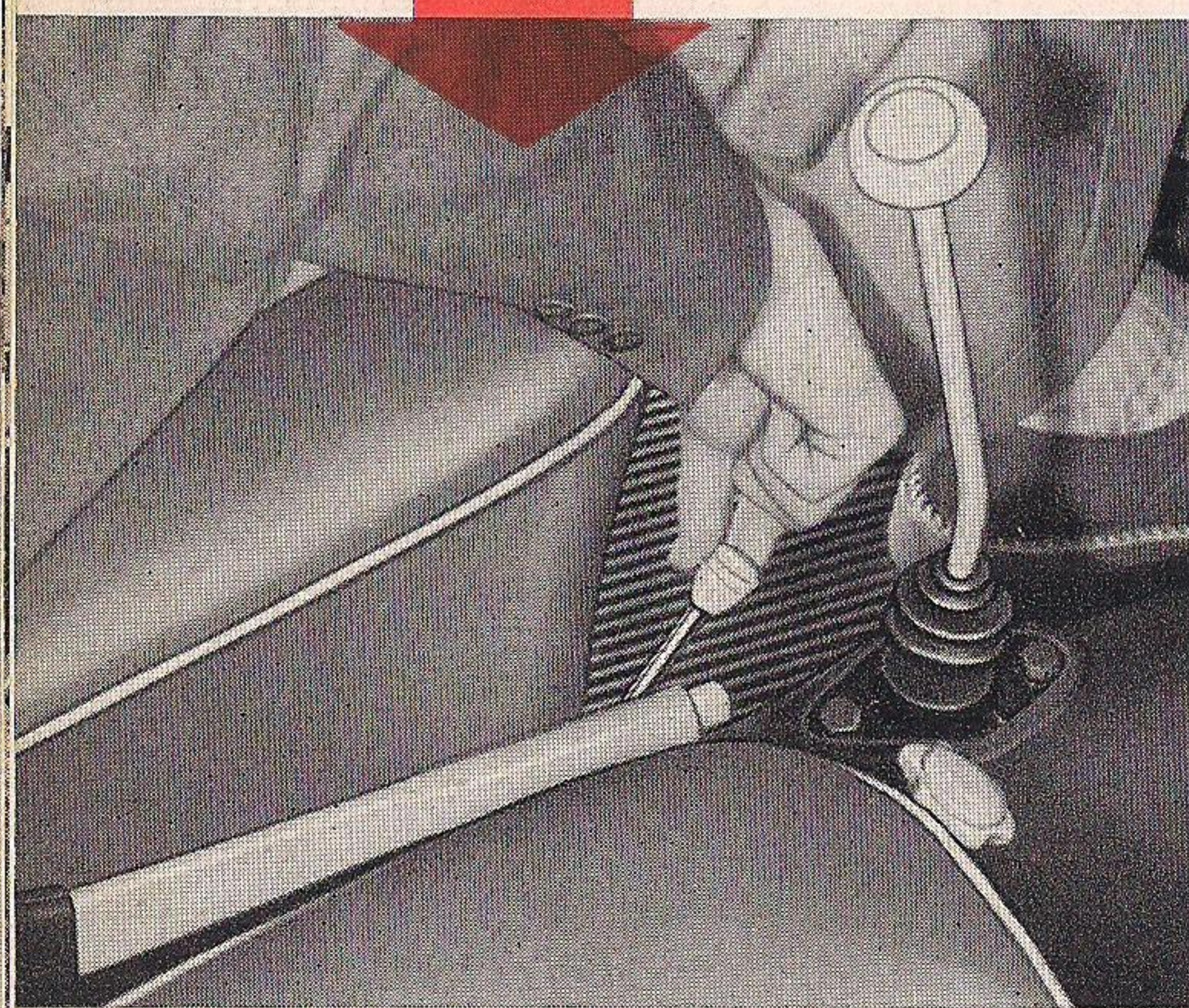

The rake of the front seat backs is adjustable by turning the knurled nut at the seat back hinge. Turning anti-clockwise (1) moves the back forward and clockwise (2) rearward.

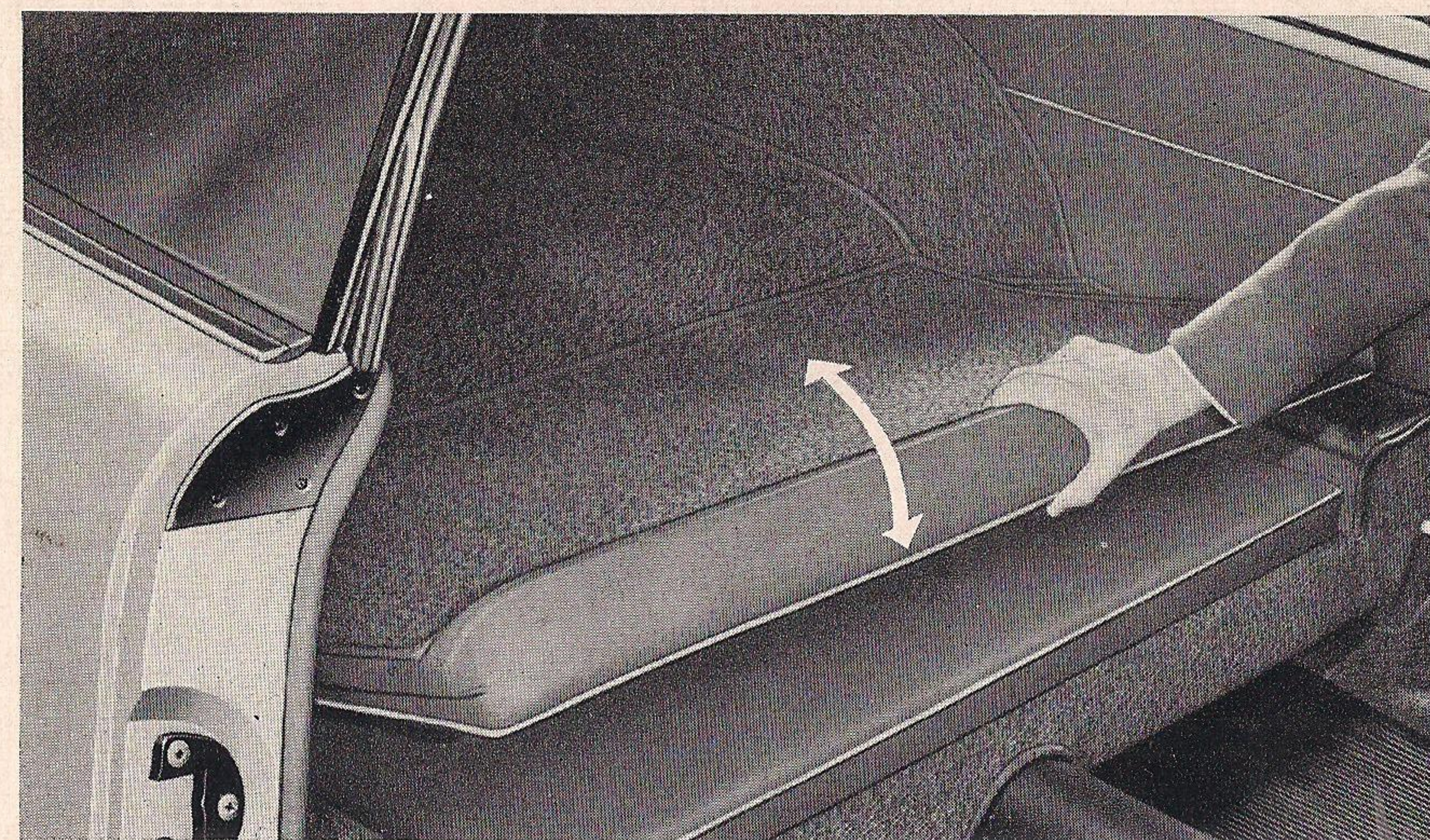

The Emergency Seat Back

can be hinged over to add to the luggage platform area.

The Fresh-Air Ventilation

will prove very efficient during hot weather. Fresh air is guided into the interior through the two defroster vents at the windshield. The air flows of the two ventilators can be controlled separately by the levers below the instrument panel. Turn knob anticlockwise to open. To close ventilator tight, turn knob fully clockwise.

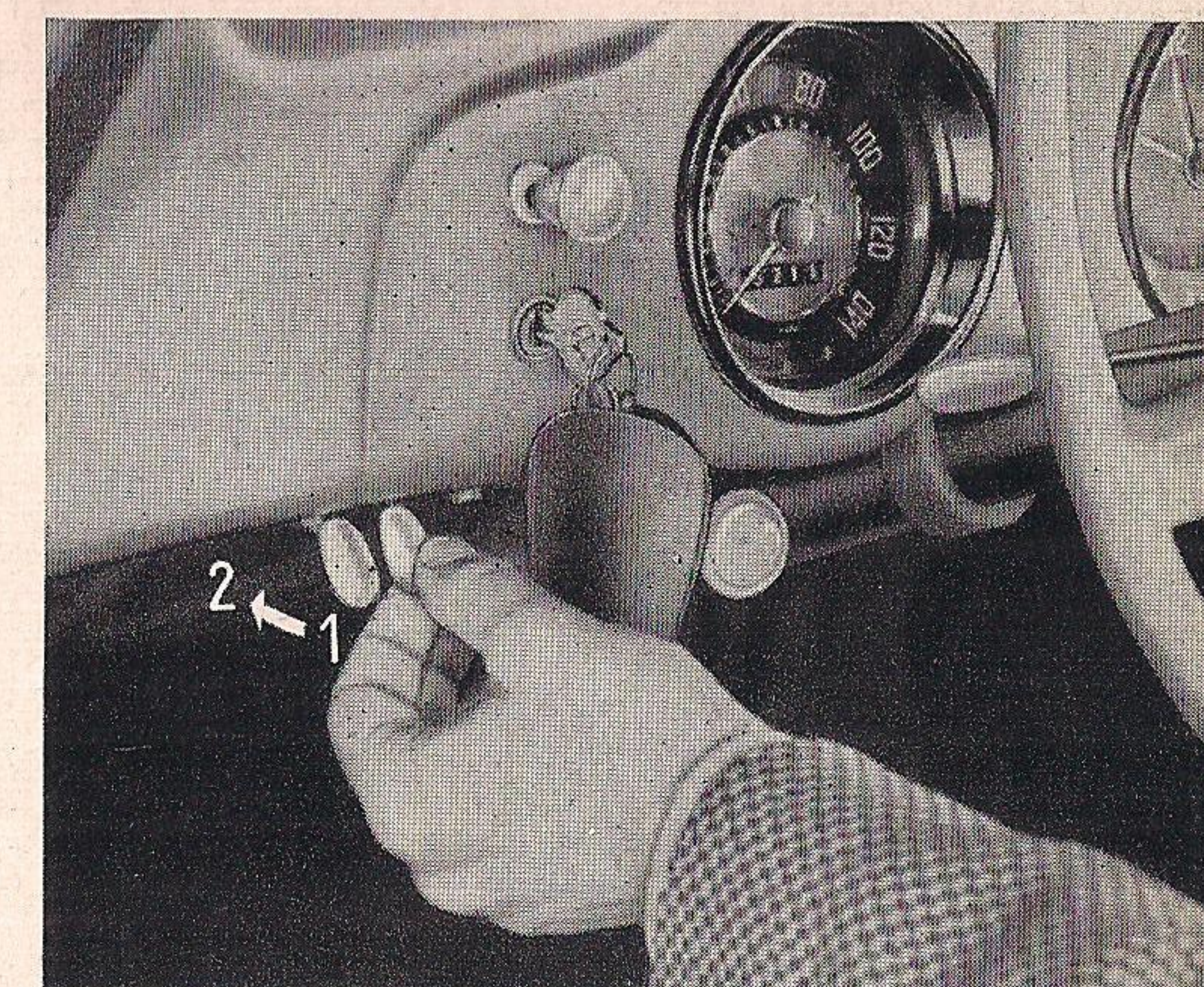

1 - To open 2 - To close

By turning on heating and ventilators at the same time, temperature can be additionally regulated by ventilator openings.

The Clock

is electrically driven. Should it become necessary to reset the clock, push in the knob in the center of the dial and turn to correct the time.

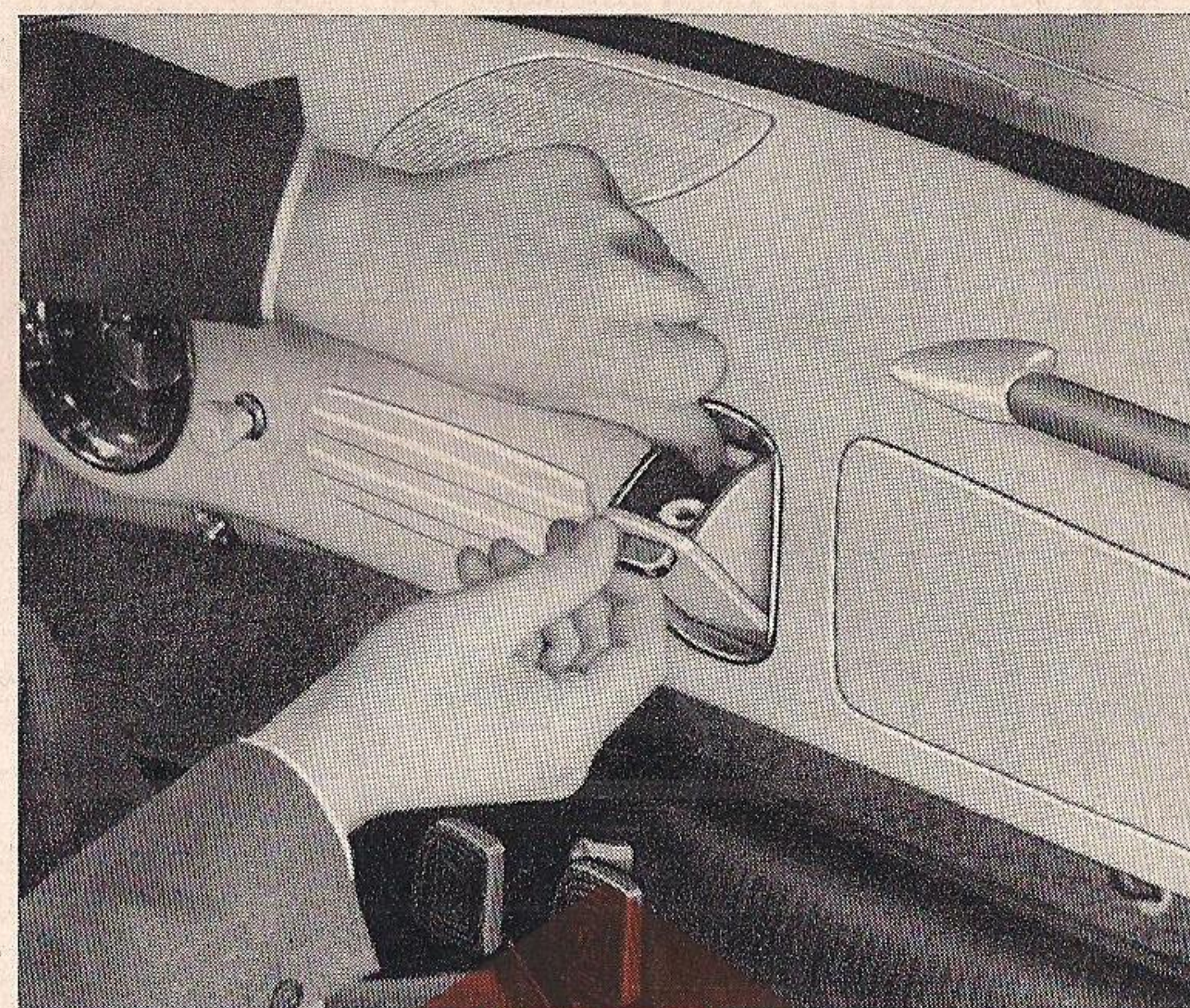
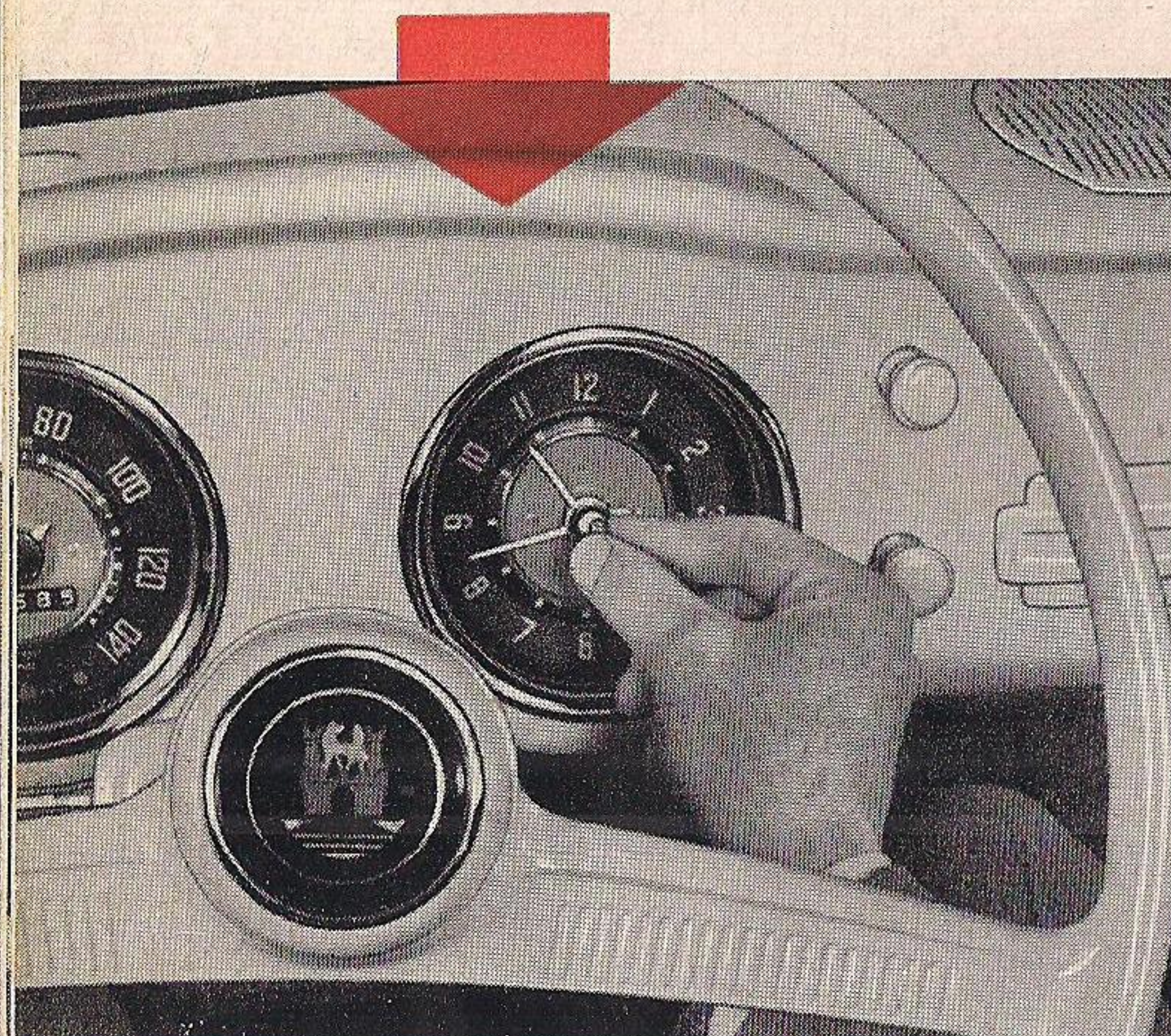

The Ash Receiver

in the instrument panel can be completely lifted out when slightly pulling up the retaining spring.

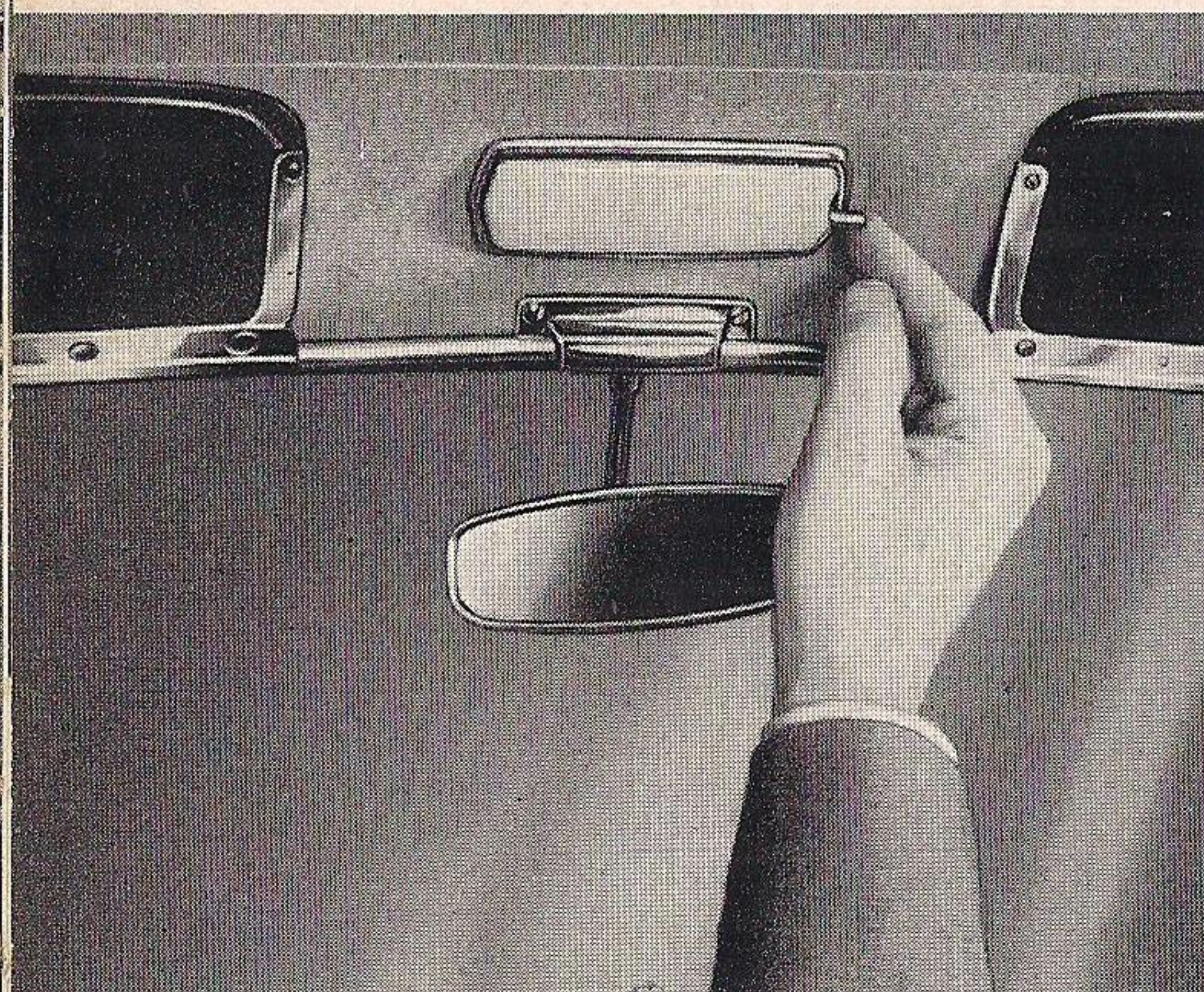

The Interior Lamp

is automatically operated by opening or closing either of the doors. As an added convenience, the lamp may be operated by the manual three-position switch incorporated in the lamp fitting.

Positions of switch:

- Upper - On
- Intermediate - Off
- Lower - Door contacts

This allows the light to be turned off with the doors open.

The Front Hood Lock

is released when pulling at the knob below the instrument panel. Then push back the safety catch to open the hood. The safety catch is to prevent the hood from opening while car is in motion, if the hood becomes accidentally unlocked.

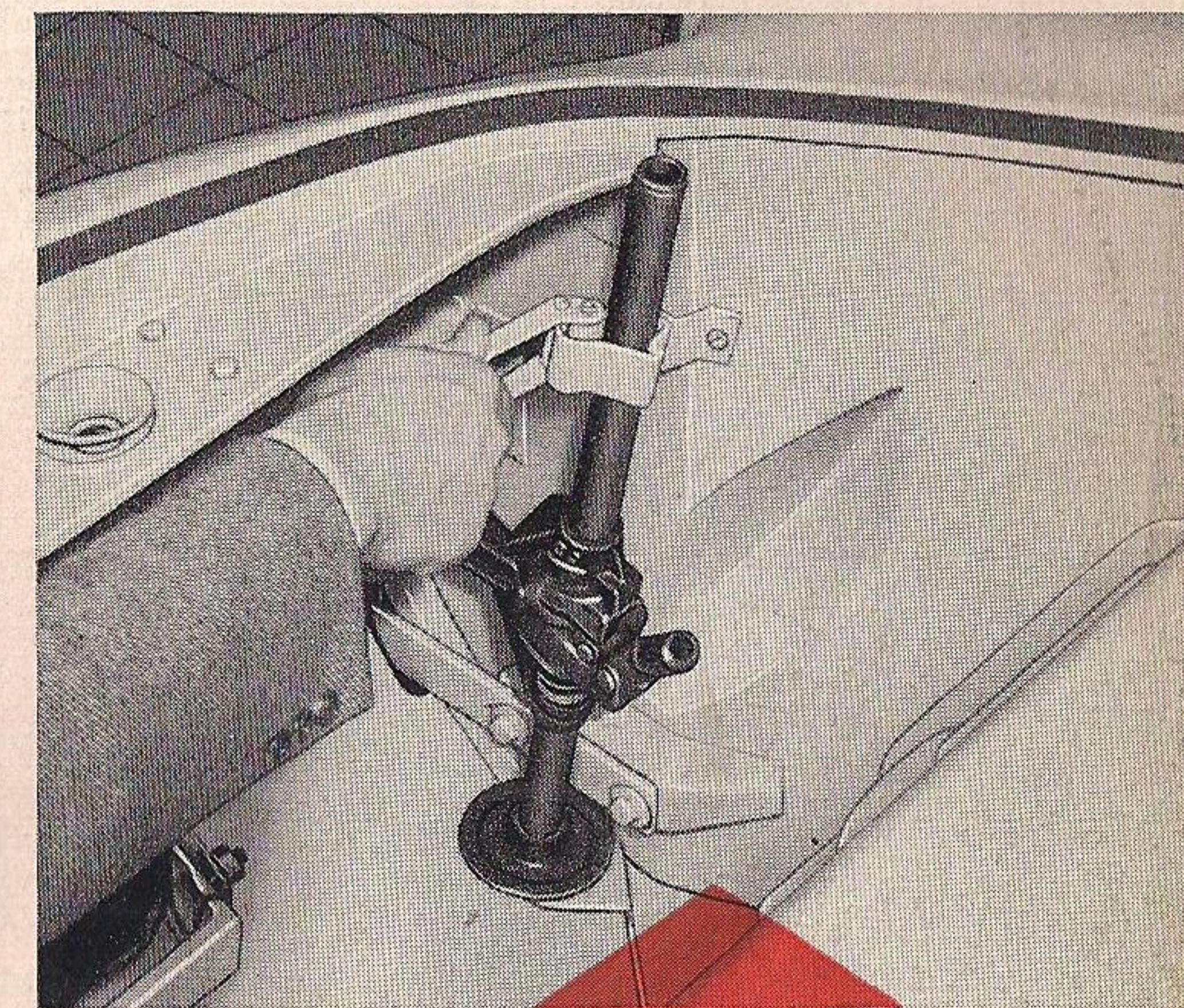
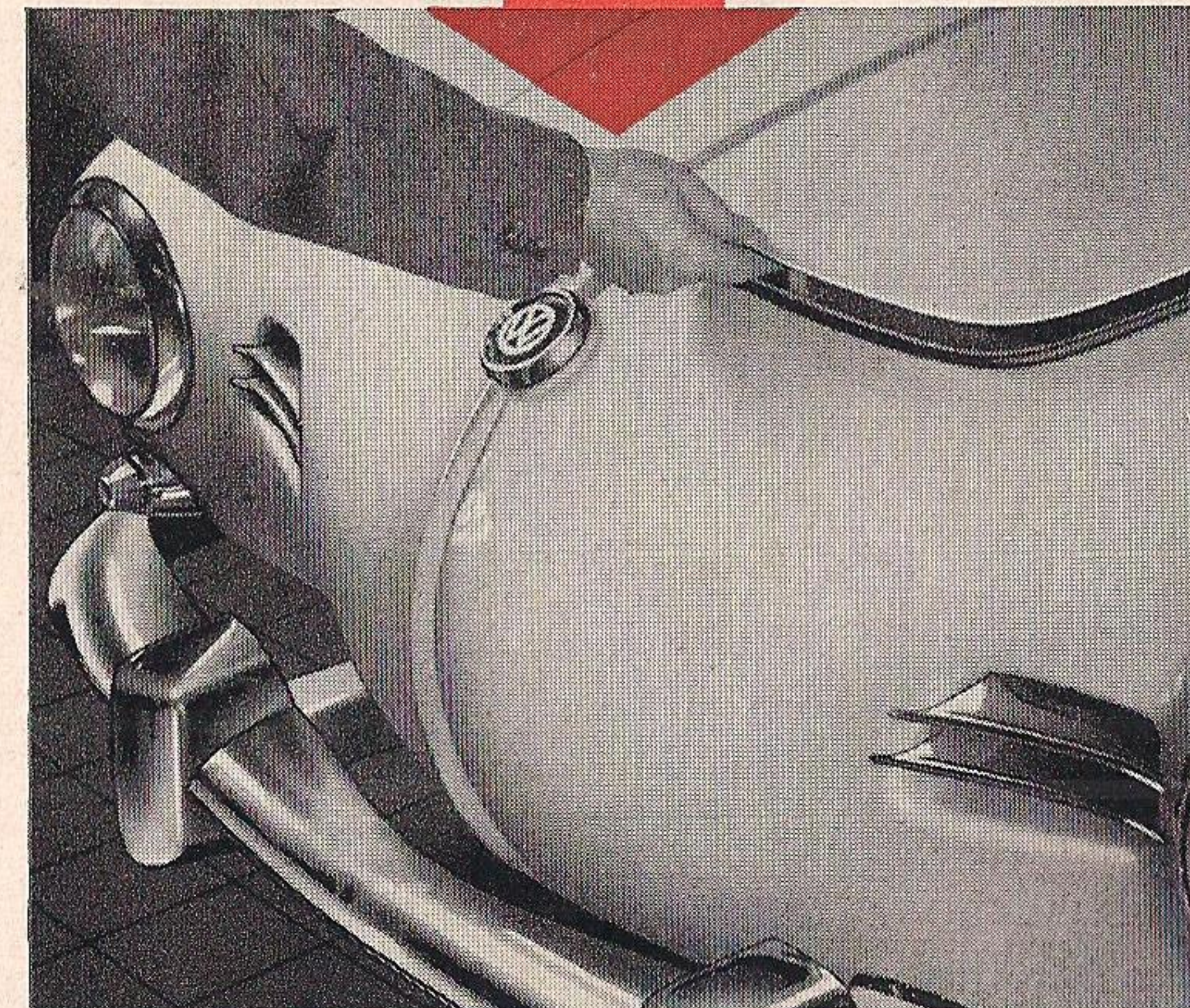

The Jack

is secured in position adjacent to the spare wheel by means of a quick release clamping strap. Also accommodated under the front hood are the tools and the spare fan belt.

The Rear Hood Lock

is released when pulling at the knob below the emergency seat bench. Balance springs hold the hood in the open position. To lock, lower hood and press down on rear end.

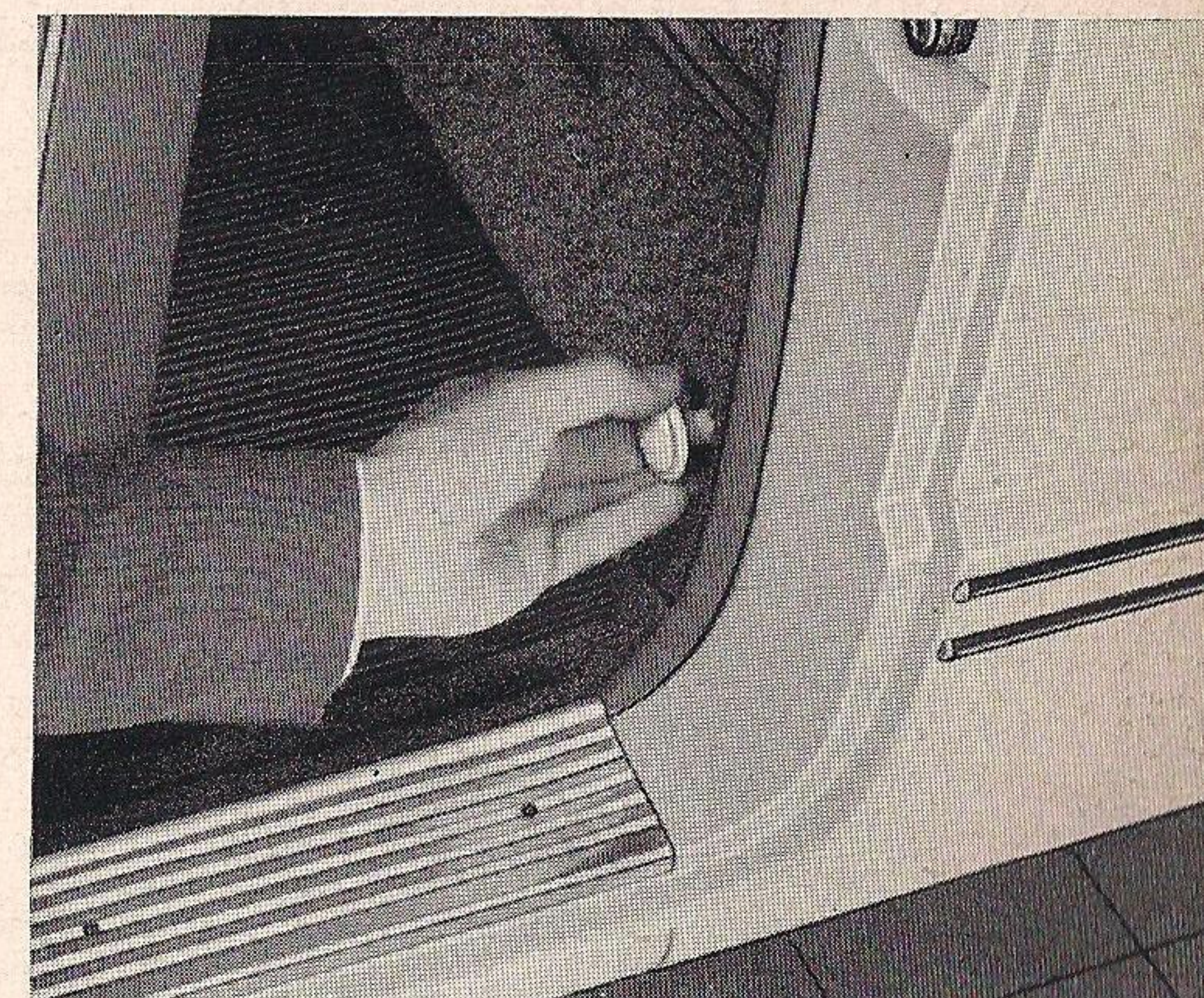

PRACTICAL DRIVING

Breaking-in (running-in) period

does not imply inconvenience as your car needs no "breaking-in."

Progressive refinements have raised the VW engine to its present predominant position and it is these refinements which allow an omission of breaking-in instructions. Your car may be operated right from the beginning at the full speeds recommended for the gears:

1 st gear	0	— 15 m. p. h. (25 km. p. h.)
2 nd gear	6 (10)	— 30 m. p. h. (50 km. p. h.)
3 rd gear	15 (25)	— 45 m. p. h. (75 km. p. h.)
Top gear	25 (40)	— 72 m. p. h. (115 km. p. h.)

For easy reference you will find the upper speed limits for the gears marked in red Roman numerals on the speedometer dial.

The life of your car, its performance, and its operation will depend on your driving habit.

Maximum satisfaction in the running of your car will be assured by following the fundamental rules for driving an automobile:

Do not unnecessarily race the engine, no matter whether the car is stationary or in motion.

The new engine is not governed. Therefore, it is good practice to glance at the speedometer hand from time to time.

Do not allow the engine to labor by driving at too low speeds.

Don't think that your engine will be saved and preserved most when it is operated at low speeds. You won't reduce the fuel consumption either. The VW engine requires air for cooling, which it gets when it is running fast enough. It is overloading and overheating that is harmful to the engine, but never high speed operation.

When driving uphill

always change gear as soon as the speed drops and the speedometer hand approaches the upper speed limit of the next lower gear. Never allow the engine to labor in 4th gear, which is nearly an overdrive, and still expect it to pick up speed on feeding more gas.

Economical operation

is one of the outstanding features of your car. However, getting a few extra miles from each gallon depends on the manner in which you handle the car and shift the gears.

When accelerating,

step on the accelerator pedal slowly and only to such an extent as is necessary for reaching the desired speed. Depressing the accelerator pedal rapidly does not improve acceleration, but results in an increased fuel consumption.

Do not "pump" the accelerator pedal

unless circumstances require it. Even the small quantity of fuel additionally discharged by the accelerator pump each time the accelerator pedal is depressed results in a marked increase in the overall fuel consumption.

Operate your car smoothly and flexibly,

both when driving in city traffic and on main roads. Adapt the speed of the car to prevailing road and traffic conditions. A good driver accelerates the car gradually, slows down in time, and utilizes the braking power of the engine. Make use of the full acceleration capacity and the excellent brakes of your car only when you really need it.

How to drive at high speed without sacrificing fuel economy

When you have accelerated the car to the desired speed, slowly let the accelerator pedal return to the position which just maintains this speed. This practice is especially economical when driving on highways.

Perhaps you are aware of the fact that air resistance is an obstacle for all high-speed vehicles. Due to the simple and sweeping lines of your car, air resistance is relatively low, but it should be remembered that high road speed always involves a greater fuel consumption.

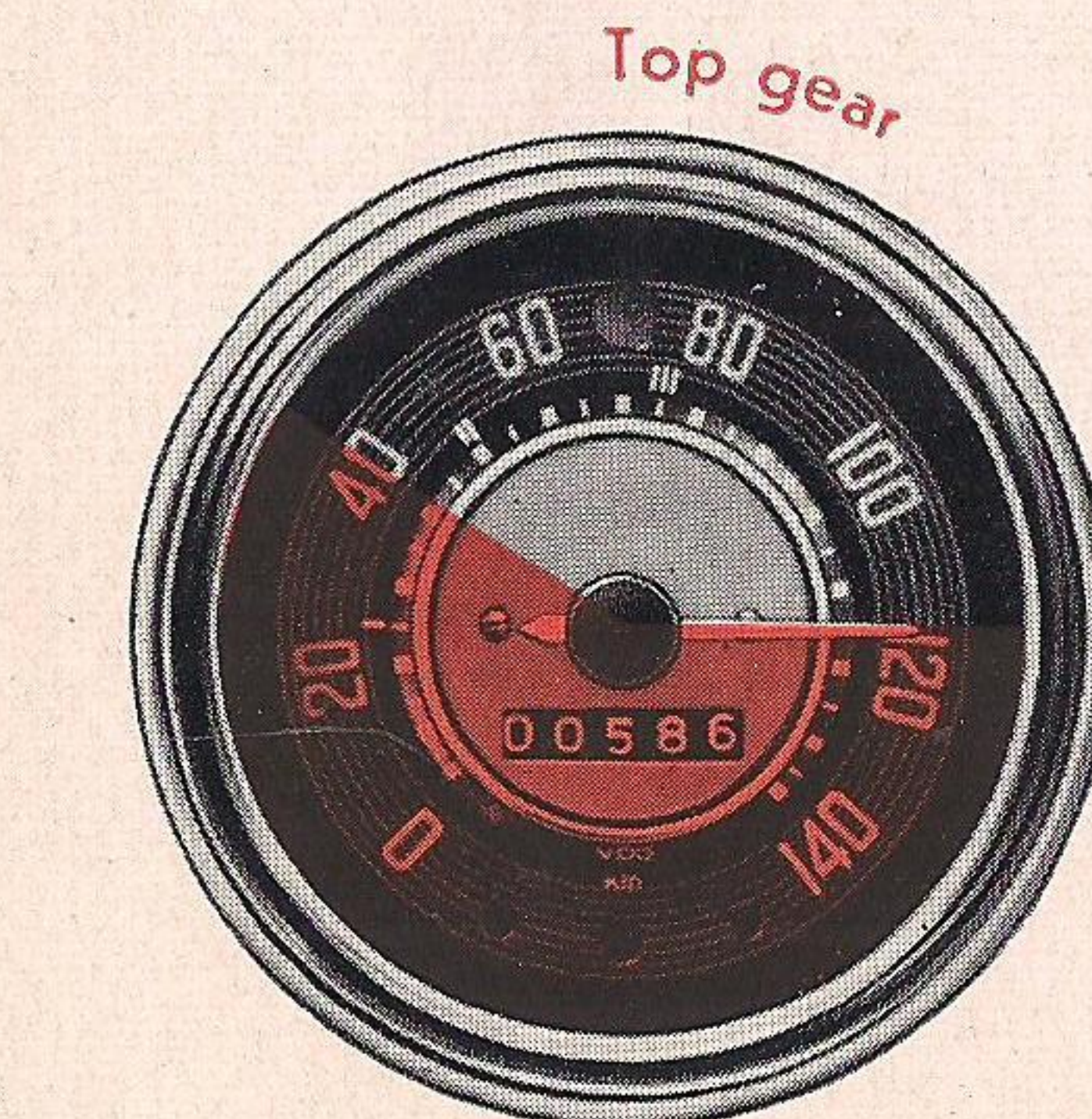
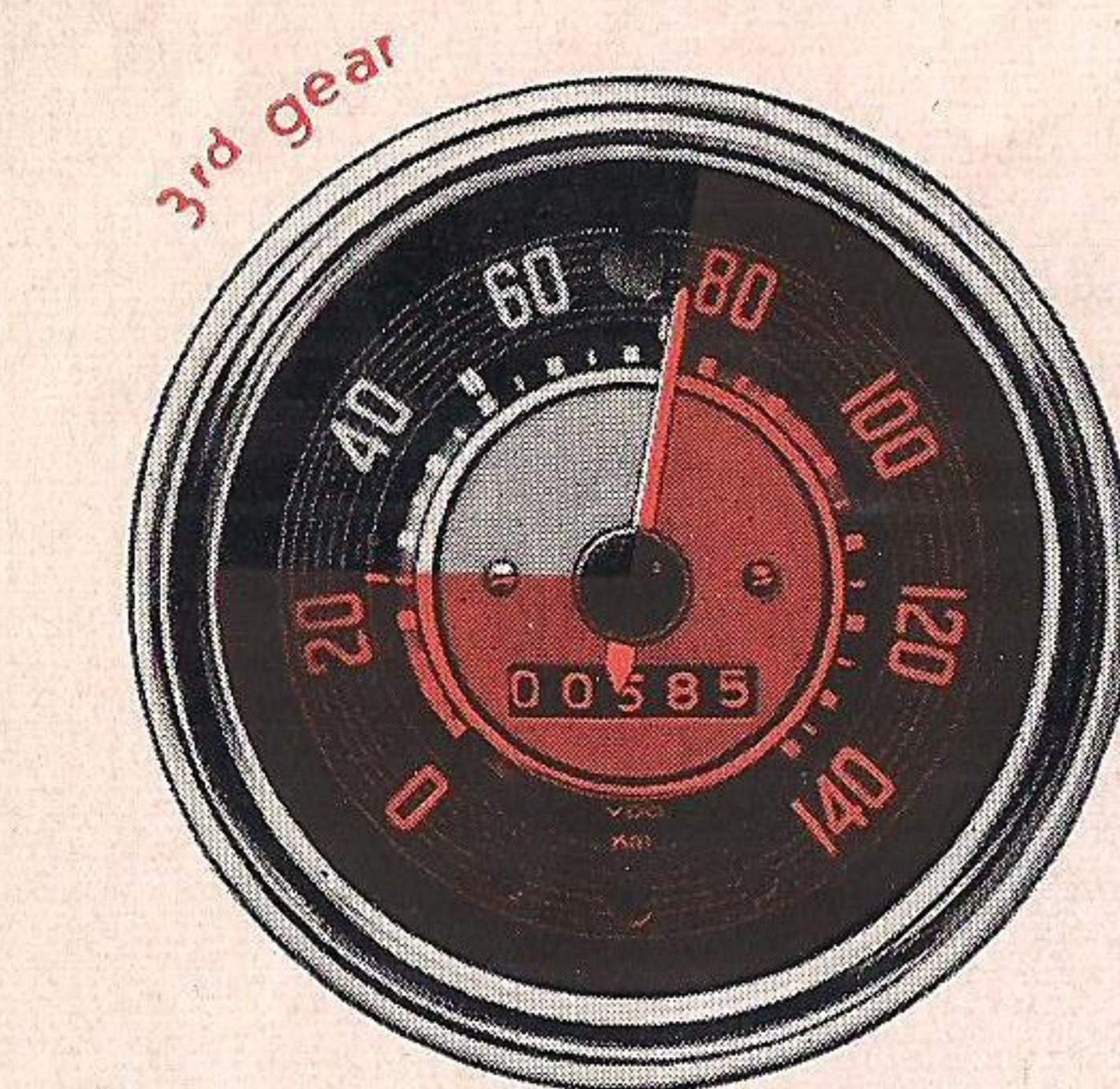
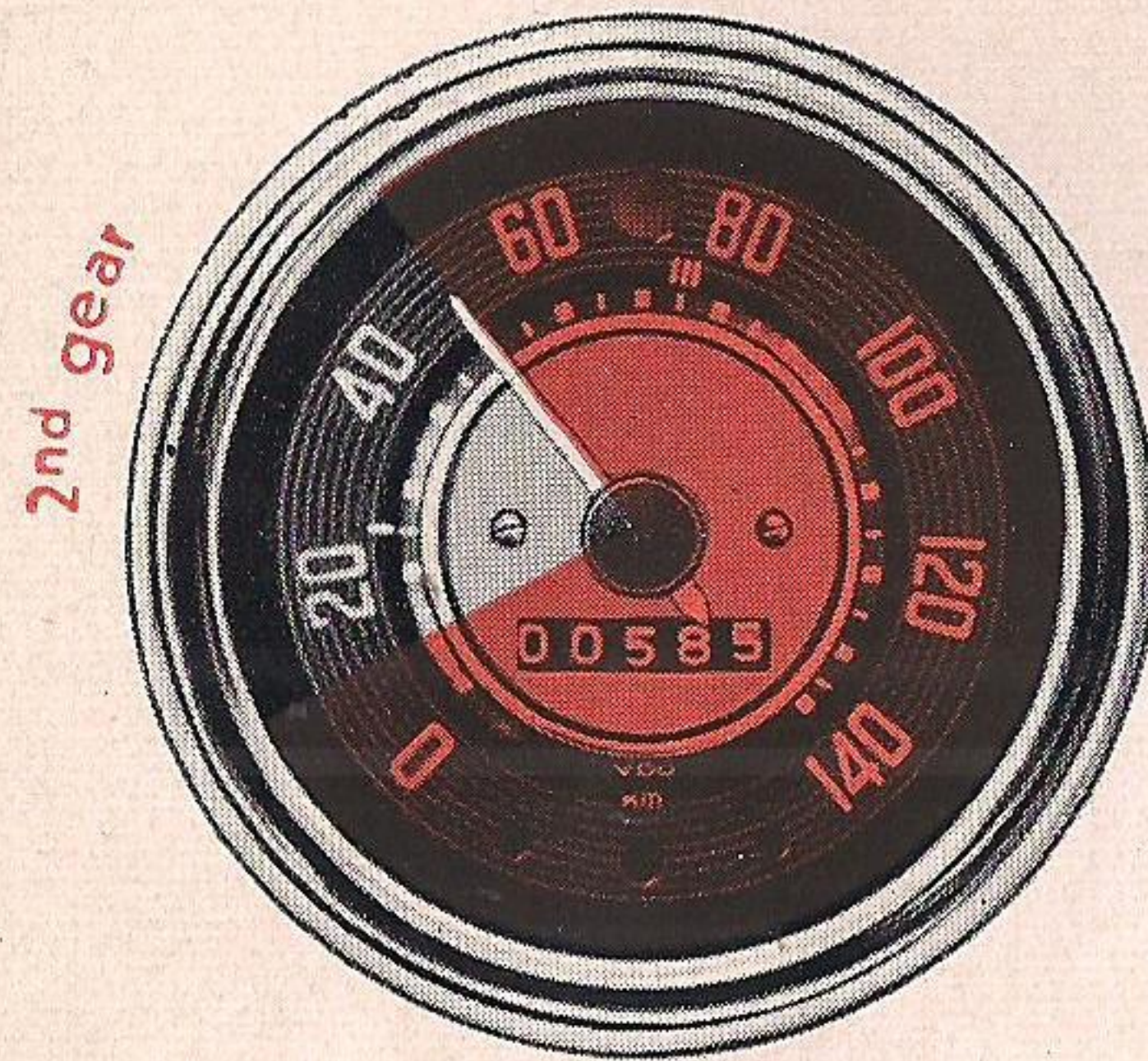
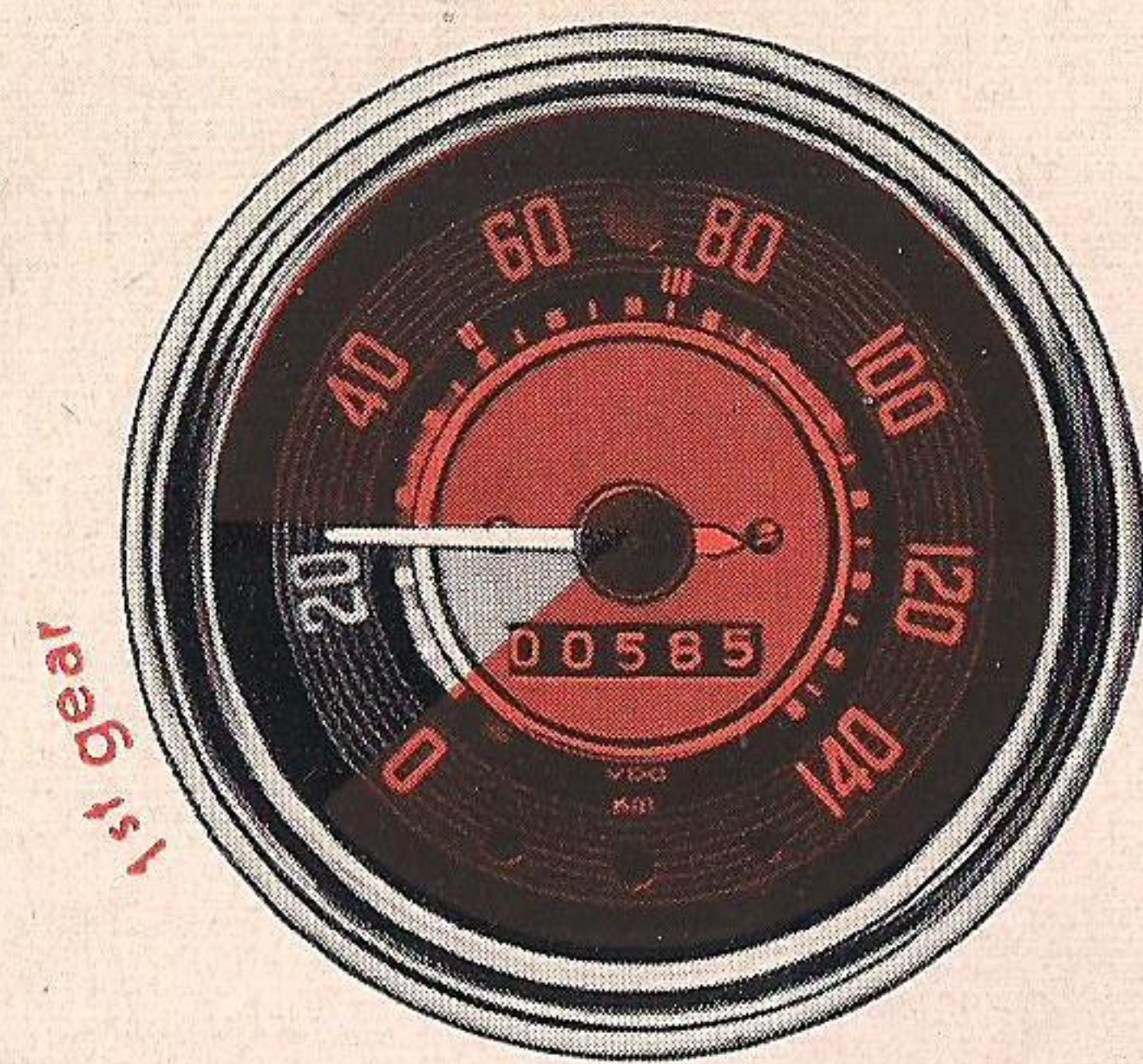

Watch the Road

closely while driving. As to using the various levers, switches and controls, you now are able to operate them automatically. Furthermore, your car on its own accord will "tell" you when it needs attention.

Direction Indicators

Red Light

The flashing direction indicators lie outside the driver's view. However, the red light will show when the indicators are turned on. The direction indicator switch can be operated without taking the hand off the steering wheel.

Generator and Cooling

Red Light

are controlled simultaneously by a red light. The light will show when the ignition is turned on and when the engine is running at low speed. The light should go out as speed is increased.

Caution! If the red light goes on while you are driving the car, the fan belt may be broken. Bring your car to a stop, and find out what is wrong, for when the belt is broken, the cooling is disrupted and the generator no longer charges.

Oil Pressure

Green Light

The oil pressure of your car is as important as the oil level, which you have already checked. When the ignition is turned on, the Green Oil Pressure Light will go on. The light should go out when the engine is started and the oil pressure increases.

Caution! If the green light goes on with the engine running, the chances are that the oil circulation has been interrupted, which means that the lubrication of the engine has ceased. Stop at once and check the level of the oil before you consult a Service Station. An occasional flashing of the lamp with the engine warm and at low speed does not indicate trouble, if the light goes off again as the speed increases.

Headlights

Blue Light

The high beam of your headlights throws glare into the eyes of oncoming drivers. You know yourself how unpleasant and dangerous this is. For this reason, be considerate! The blue light will tell you when the high beam is switched on. Just step on the dimmer switch to transfer the headlights from high to low beam and vice versa.

Safety First

Safety for yourself, and safety for others, this is what counts most! Your car "hugs" the road in an excellent way, and does not roll when taking a turn. Your car has an extraordinary capacity for acceleration. Yet, the feeling of security and safety which you will acquire after a few miles should not tempt you to become careless.

Therefore, adjust the speed of your car to the conditions of road, traffic and weather, and always be ready to bring your car to a stop when it is necessary. Be particularly careful when driving on wet or icy roads, for even this excellent car is apt to skid when not driven carefully under such conditions.

Rear View Mirror

By turning the mirror to the vertical position, an additional adjustment is obtained to suit individual requirements.

Passing other Cars

Pass other vehicles with consideration. Always be sure that the road is clear ahead of you, and look out for cars approaching you from the opposite direction. A brief look in your rear view mirror will tell you whether another car is about to pass you from behind. And here is another warning: Never try to pass a car when approaching a curve, where vision is not clear, and never pass a vehicle at the crest of a hill, or at crossroads! You never can tell what lies ahead of you! Be fair and do not step on the gas pedal when another car tries to pass you. You will endanger your life and others!

Stopping Your Car Temporarily

When stopping your car in front of a traffic light or railroad crossing, do not wait for free passage with the clutch pedal pressed down and the gear lever in position! Shift to first gear shortly before moving on again, it will preserve the clutch!

Parking Your Car

in a space between two other cars that are parked at the curb will be fun for you if you heed the following advice:

Stop your car even with the car in front of the space. Turn the steering wheel sharply to the right and back your car slowly into the gap.



When the front bumper of your car is even with the rear bumper of the car ahead of you, turn the steering wheel fully to the left, and back up further toward the curb.

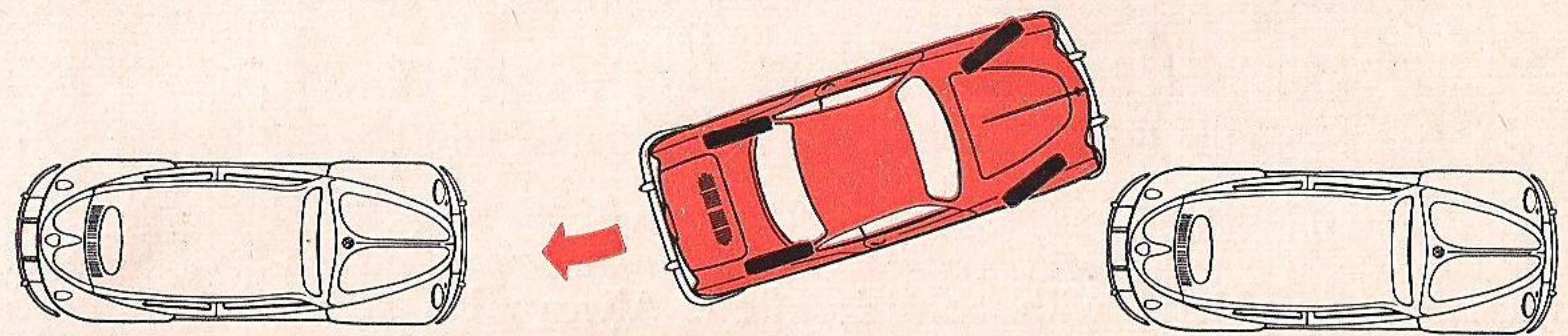

Now turn the steering wheel again to the right and pull up a little bit, until both ends of the car come as close to the curb as possible.

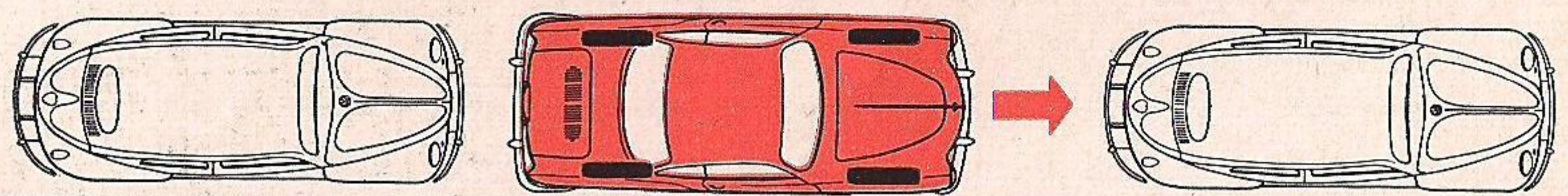

When parking on a steep grade, set the hand brake so as to keep the car from rolling. As a precautionary measure, it is advisable to engage first or reverse gear in addition to the hand brake. And do not forget to take the key out of the ignition switch before you leave your car!

Do not forget to shut the fuel tap when parking on a grade with the rear end of the car downwards.

Prior to locking the left-hand door, secure the right door by pushing the inside door handle forward. The vent wing handle is locked by turning it to the position where the push button is heard to engage.

COLD WEATHER HINTS

In Winter

there are two advantageous features of your car that you will appreciate most:

Air Cooling and Heating

You may expose your car to bitter cold without fear:— its air-cooled engine will always be ready to start! You will drive in warm comfort, well protected from drafts and free from sleet and snow, while a current of warm air will keep your windshield from condensation and frost, permitting you a clear view. The increased stress that your car has to stand in winter because of frost and dampness can be easily dealt with if you observe the recommendations presented in this section.

Never attempt to influence the cooling and heating of your car in winter by covering the air intake slots below the rear window.

This would be harmful to the engine, as the drawing in of fresh air for the carburetor and the heating would be seriously affected. The intake of cooling air is already efficiently controlled by the thermostat.

The Warm Air Heating

of your car can be regulated by a rotary knob situated adjacent to the gear lever:

Anti-clockwise - On (A)

Clockwise - Off (Z)

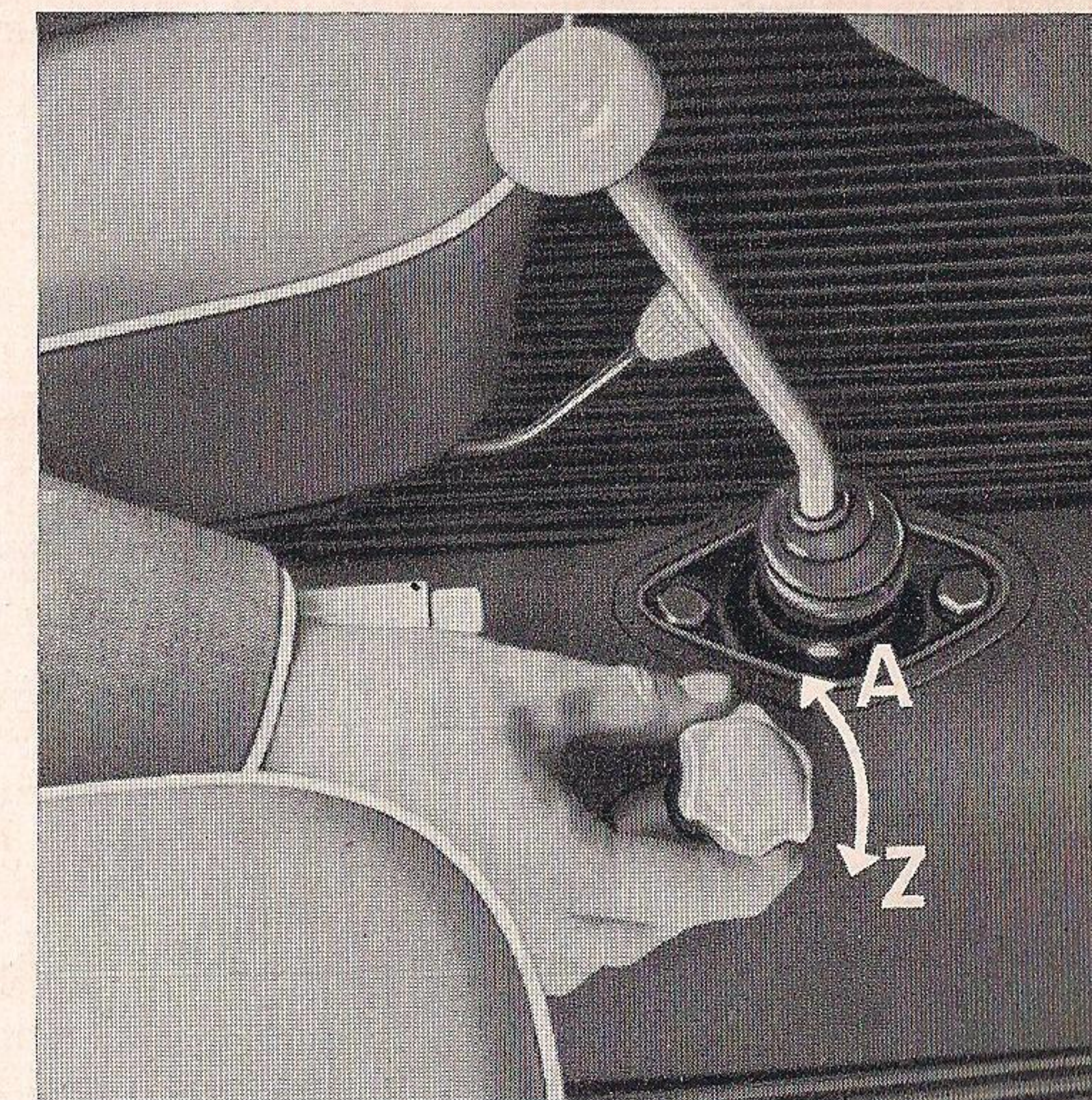

Engine Oil

SAE 20/20 W oil will not congeal at temperatures above 0° C (+32° F) and will permit easy starting of the engine. If, however, the anticipated atmospheric temperature during the interval in which the oil will remain in the crankcase is below freezing point, it is recommended to use SAE 10 W oil.

This grade oil may remain in the engine with safety when the temperature again rises to a higher range. Should it become necessary to add oil in the period between two regular oil changes, SAE 10 W oil may be used at lasting frost and SAE 20 W oil when the temperature average rises. This means that the grades SAE 10 W and SAE 20/20 W can be mixed without involving any disadvantages, but be sure to use always the same brand and type of engine oil.

In extremely cold weather, allow the engine to idle for half a minute before driving away to insure correct oil circulation.

Don't race the engine in severe frost to obtain a quick start.

Only if your car is mainly operated for short distances during cold weather it is recommended to have the oil changed at more frequent intervals, say every 2500 km. (1500 miles), using the right HD oil (for Service MS). In the warmer season, oil changes in addition to those laid down in the Lubrication Chart are unnecessary and uneconomical.

In territories where exceptionally low temperatures prevail (below -25° C / -13° F), it is recommended to use SAE 5 W engine oil, which should be changed every 1250 km. (800 miles).

Transmission Lubricant

SAE 90 gear lubricant is recommended for use when the average temperature range will not be lower than 0° C (+32° F). However, where the temperature is expected to remain below freezing point for an extended period of time, SAE 80 grade should be used.

The Chassis

is particularly exposed to moisture in winter. For this reason it will be necessary, and only logical, to adhere strictly to our instructions for lubrication. If, in addition, you will spray the bottom of the car with a special chassis oil, as a protection against rusting, you will prolong the life of your car.

Annually, at the beginning of the cold season, clean and grease the cables for carburetor, clutch, and heating.

The Brakes

of all automobiles are exposed more or less to splashing water that in winter is apt to freeze in the brake drums. Therefore, when parking your car, do not set the hand brake, but shift to first or to reverse gear.

At the beginning of the cold season, the conduit tubes of the brake cables should be thoroughly lubricated with anti-freeze lubrication grease. Do not use just any car-lubricant, but get the right one at any VW Dealer!

Tires

Worn off tires are apt to cause trouble in winter. To assure a safe operation, replace them in time. To meet the special requirements in winter, so-called M+S tires are available. These special-tread tires are designed to give a better grip on mud and snow. They are either used on the rear wheels only or on all four wheels. However, during the rest of the year you should rather use the usual tires.

Non-Skid Chains

You will need non-skid chains only when the roads are covered with snow or ice. Without such chains, the rear wheels of your car are apt to spin, and applying the brakes may result in the car skidding. Have the non-skid chains adjusted to the wheels, if you wish to avoid loss of time and inconveniences later on!

When driving on long stretches that are free from snow, the chains should be removed to prevent excessive wear of both chains and tires.

The Battery

is under greater strain in winter than in warmer seasons because of the increased consumption of current when starting engine and using the lights at night. Besides this, it is a characteristic feature of any battery that its efficiency decreases at lower temperature. If the car is mostly operated for short distances, the battery may call for an additional recharging.

Therefore, have your battery checked regularly, and you will never encounter any starting difficulties.

Spark Plugs

will aid cold starting substantially in extremely cold weather when reducing their gaps to 0.4 — 0.5 mm. (.016" — .02").

When seasonal temperatures rise, or when the car is to be driven in areas where higher atmospheric temperatures are encountered, reset the spark plugs to their normal gaps of 0.6 — 0.7 mm. (.024" — .027").

CHAMPION L7 REPLACES L10S
L85 " L7

LUBRICATION

Proper Lubrication is of Vital Importance to Your Car

The extra time spent in following these recommendations will be amply rewarded in the long run by your car's efficient performance. It is up to you to maintain the standard of safety offered by your COUPE, and to insure the long life and good service which you have the right to expect from this truly economical car!

To lubricate correctly means to lubricate amply and at prescribed intervals!

Therefore, do not shy at the work connected with the regular lubrication service. A Lubrication Chart can be found on page 65, indicating the respective mileages at which to lubricate.

The Service Booklet makes it possible for you to have your car lubricated by a VW Dealer by skilled hands, with the best available lubricants, at lowest cost and in a minimum of time. You really cannot afford to miss this opportunity!

Engine Oil Change

Regular oil changes are necessary even if the very best trademark oils are used. Diluted and dirty oil in your engine simply means a greater strain and a shorter period of life for your engine. On the other hand, provided that HD oil is used, it is unnecessary and uneconomical to change the oil more frequently than called for in the Lubrication Chart.

The oil is drained by removing the plug at the bottom of the crankcase. To insure complete draining, it is important that the operation be performed while the engine is warm.

The engine is refilled with **2½ liters of HD oil** (5.3 U.S. pints, 4.4 Imp. pints).

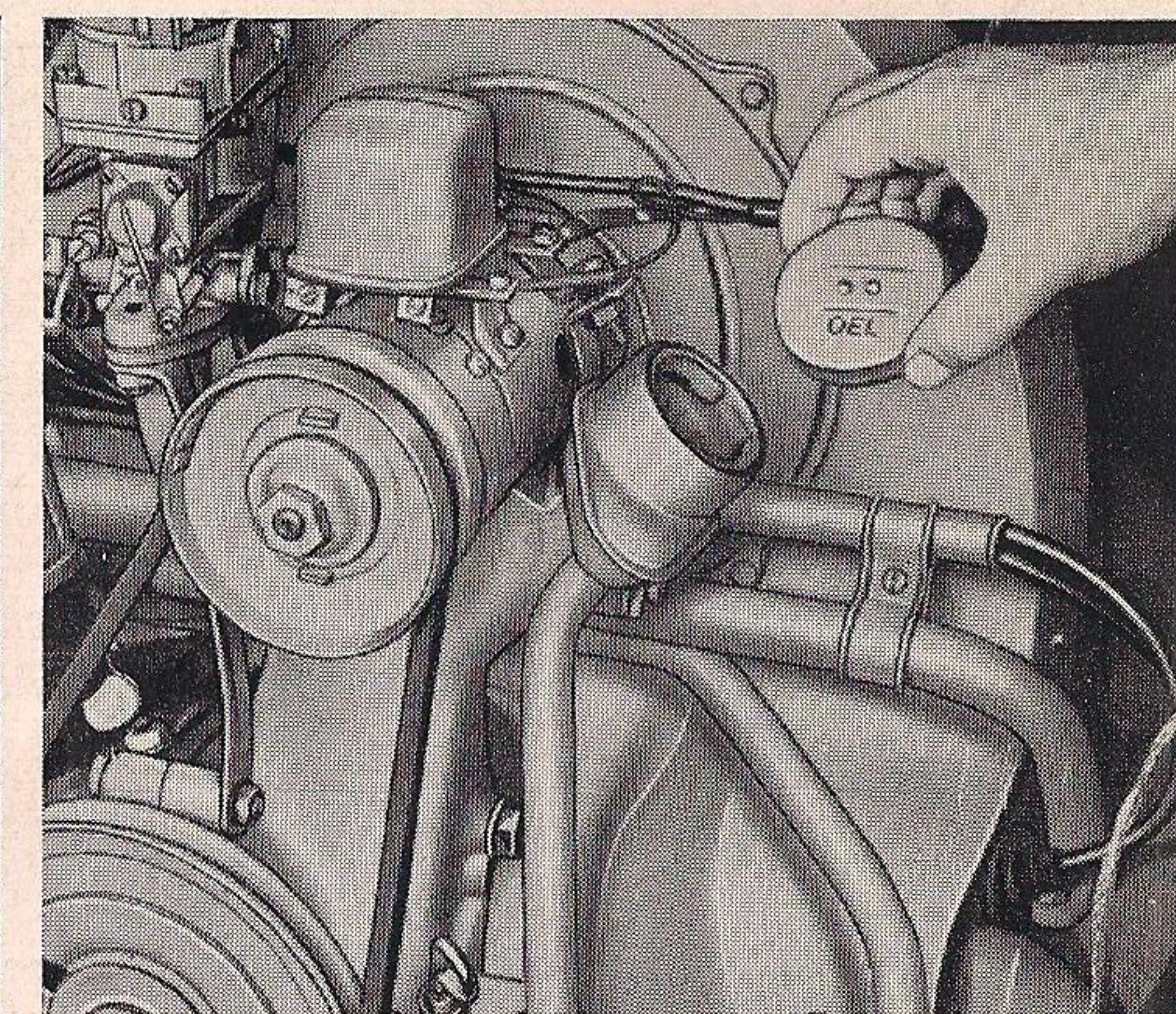
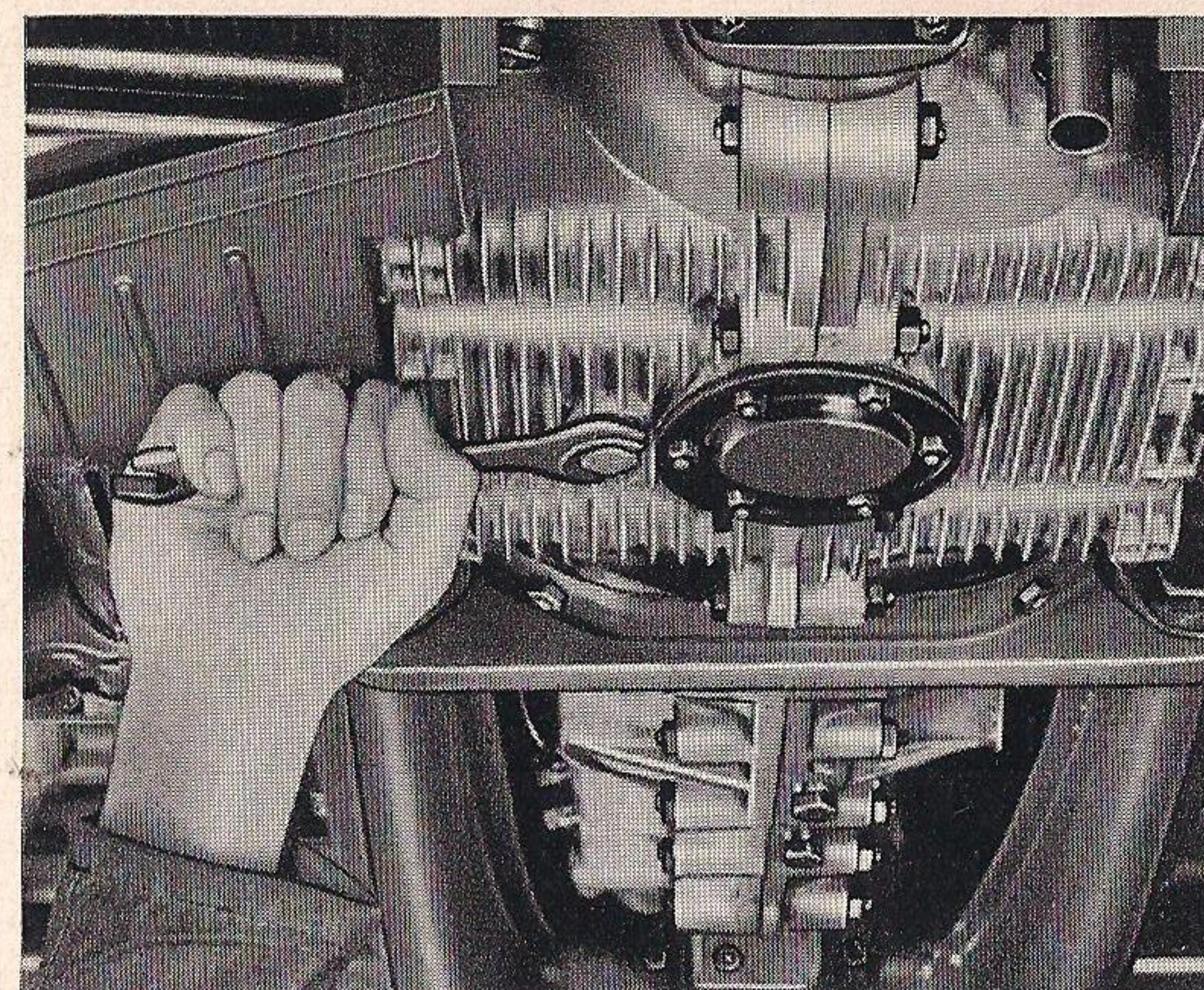

The constant use of HD oil (for Service MS) renders a flushing of the engine unnecessary.

If, however, being compelled to use a Regular engine oil not having the detergent-dispersant characteristics of HD oil, the oil should be changed at intervals of 2500 km. (1500 miles). The engine should be allowed to idle while being flushed thoroughly with one liter (1 quart) of the same type of oil which you use afterwards for filling. This assures a better cleaning of the complete lubrication system. Under no circumstances a so-called flushing oil, or even kerosene, should be used for flushing the engine. The residue of the flushing agent, which would remain in the crankcase and especially in the oil cooler, is liable to decrease the lubricating efficiency of the fresh oil.

Never allow a haphazard changing from HD oil to Regular oil.

The Oil Strainer

retains foreign matter and should be taken out and cleaned as called for in the Lubrication Chart. The two gaskets should be replaced each time the strainer is removed.

- | | |
|------------------|-------------------------|
| 1 - Drain plug | 4 - Gasket |
| 2 - Gasket | 5 - Bottom plate |
| 3 - Oil strainer | 6 - Nut and lock washer |

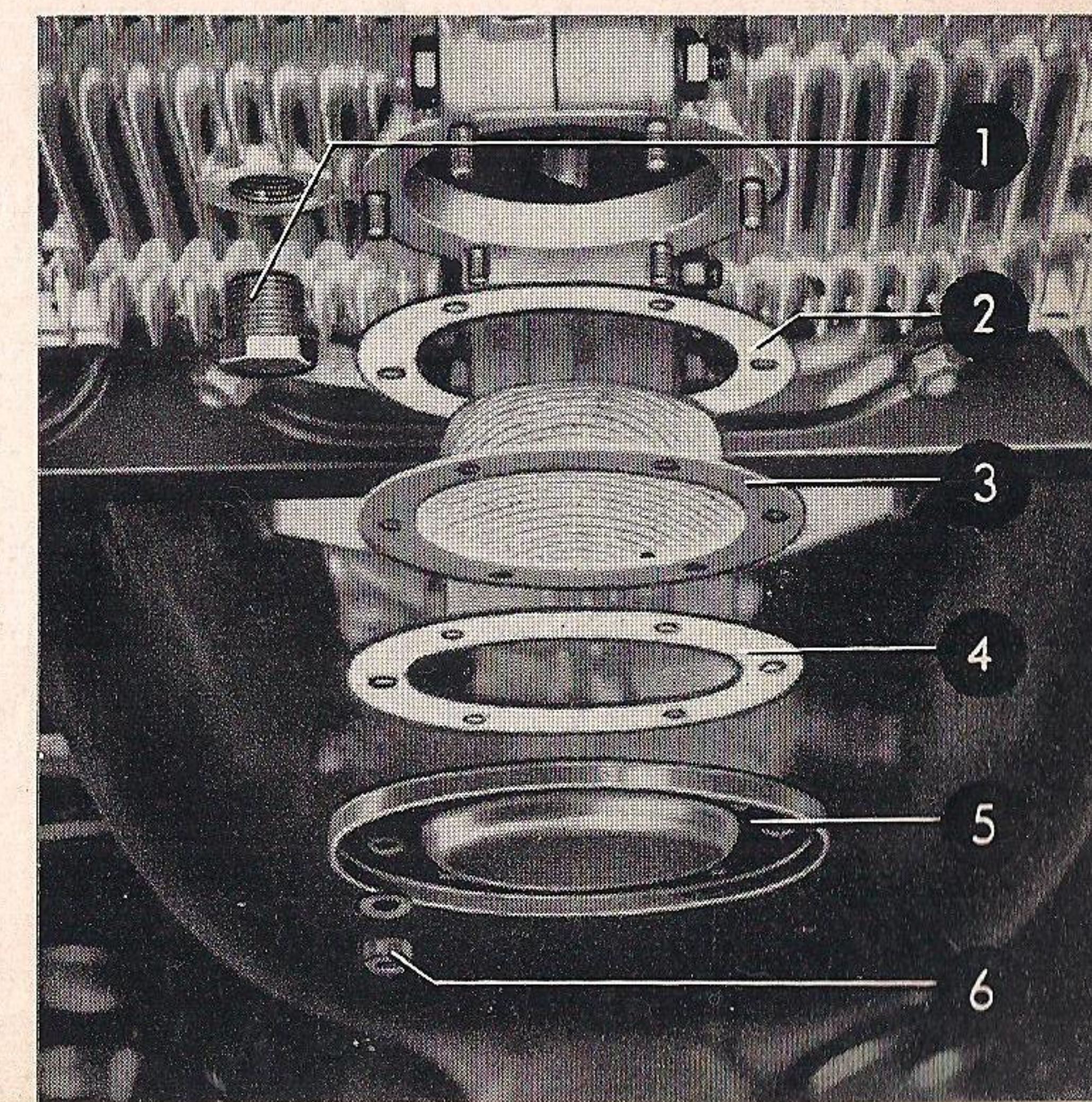

Types of Lubricant and Recommended Usage

The advantages of using a **trade-mark HD engine oil** (for Service MS) are quite evident.

Regular oils, i.e. non-additive oils, do not combat the formation of sludge and deposits and the wear-increasing bearing corrosion when the car is operated for short distances and during cold weather.

HD oil is an oil having proved oxidation stability, bearing corrosion preventive properties and detergent-dispersant characteristics which tend to hold in suspension foreign contaminants which would normally deposit on engine parts. These foreign contaminants will drain out with the oil at the periodical oil changes. The detergent properties of HD oil will make the fresh oil darker already after a short time of operation. This is quite natural and there is no reason whatsoever to change the oil earlier than called for in the Lubrication Chart.

Additional lubricating agents should not be added to HD oil.

Changing from one Type of Oil to Another

If possible, HD type oils (for Service MS) should be used for all new VW engines right from the beginning. If, for any reason, the engine has operated with Regular engine oil for a longer period, the following should be heeded when changing to HD oil.

- **If engine has run more than 10 000 km. (6 000 miles)**
no precautions are necessary when changing to HD oil.
- **If engine has run less than 10 000 km. (6 000 miles)**

or if you are not quite sure what type of oil had been filled into the engine at earlier oil changes, precautions must be taken to thoroughly clean the engine. The VW Service personnel is fully conversant with this job and will be glad to advise you.

Some More Information on Engine Oils

It is left to your discretion to select an oil from well-known and dependable brands being of the proper viscosity to suit your seasonal and driving requirements. In cases of doubt, refer to your authorized VW Dealer who will be glad to help you

with your lubrication problems. It is recommended that you select "your" oil already after the first 500 km. (300 miles) and stick to it at all future service oil changes.

Viscosity of the lubricant is an indication of its resistance to flow at a given temperature. The SAE numbers classify lubricants in terms of viscosity, but with no reference to other characteristics or properties.

SAE 30 engine oil is satisfactory in tropical climates where the temperature range will frequently rise above 30° C (86° F).

SAE 20/20W engine oil is recommended for use within the mild temperature range from +30° C to 0° C (+86° F to +32° F). It may also be used with safety, should temperatures temporarily exceed these limits.

SAE 10 W engine oil is recommended for use if the atmospheric temperature is anticipated to fall below 0° C (+32° F). It may also be used with safety, should temperatures rise above freezing point. A change of oil is, therefore, not necessary until the next regular mileage interval.

SAE 5 W This extremely light engine oil is for use in arctic climates only.

In some countries API Classification is applied (API = American Petroleum Institute). According to this classification, HD oils suitable for the VW engine are referred to as "For Service MS".

Ignition Distributor

The amount of grease at the breaker arm fiber block should be checked and, if necessary, replenished at the specified intervals.

Every 25 000 km. (15 500 miles), apply 2 or 3 drops of oil to the felt (wick) in the cam bearing after the rotor is taken off.

Transmission and Differential

The transmission gears and the differential of your car are combined in the transmission case and are both lubricated with the same gear oil. This kind of oil can be

readily distinguished from engine oil by its heavier viscosity and darker coloring. An early change of oil, while the gears are being broken in, will contribute to a smoother operation of the transmission. The used oil should be drained by simultaneously removing the two drain plugs, while the oil is still warm.

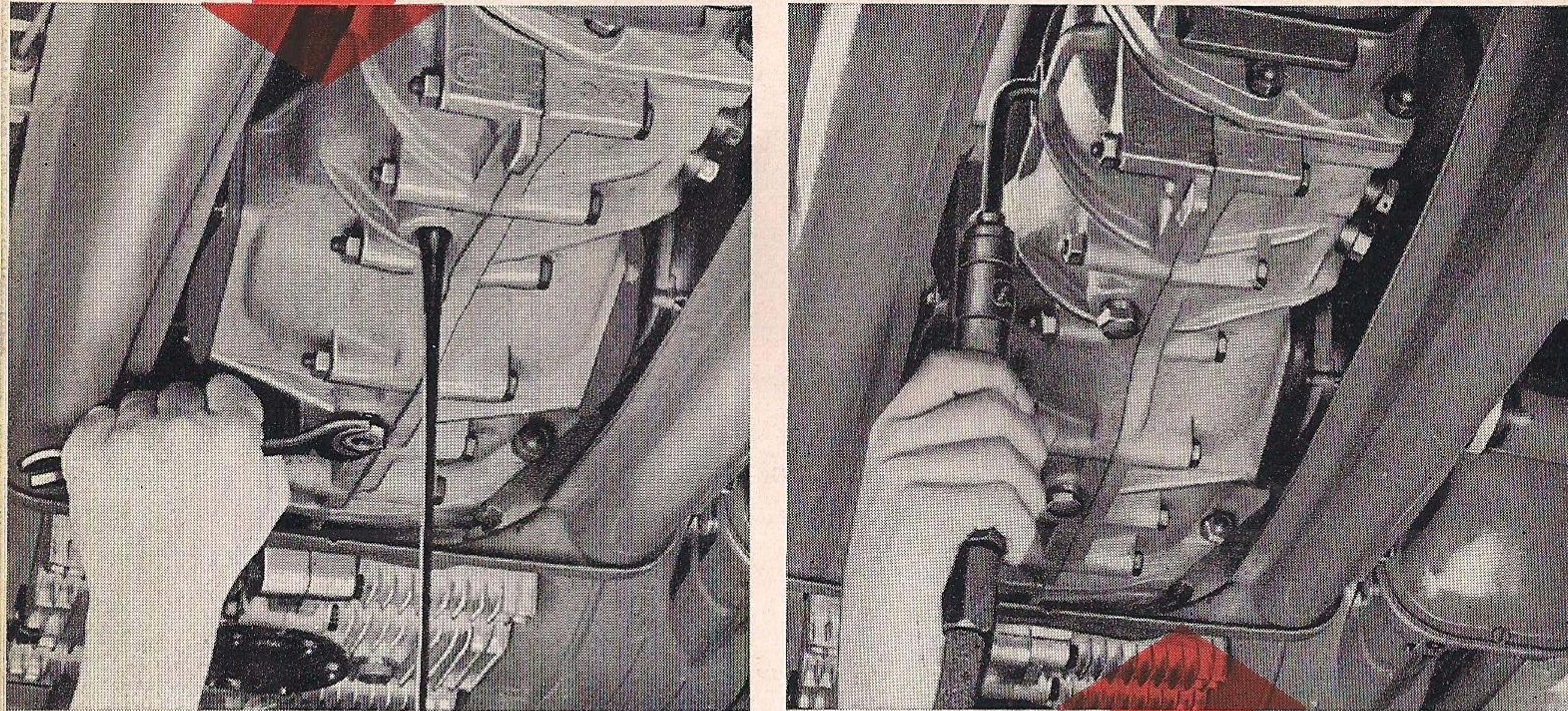

Then refill with **2 liters (4.2 U. S. pints, 3.5 Imp. pints) gear oil.**

The oil level should be checked in accordance with the Lubrication Chart. Keep the lubricant level somewhat below the edge of the filler hole.

In order to maintain the characteristics of the gear oil, it should not be mixed with any other oil, as the two will not blend.

Steering Gear

The steering assembly should be lubricated with gear oil exclusively, and under no circumstances with grease or hypoid oil. It is accessible through a hand-opening behind the spare wheel. The level of the oil in the steering case should be kept somewhat below the filler plug hole.

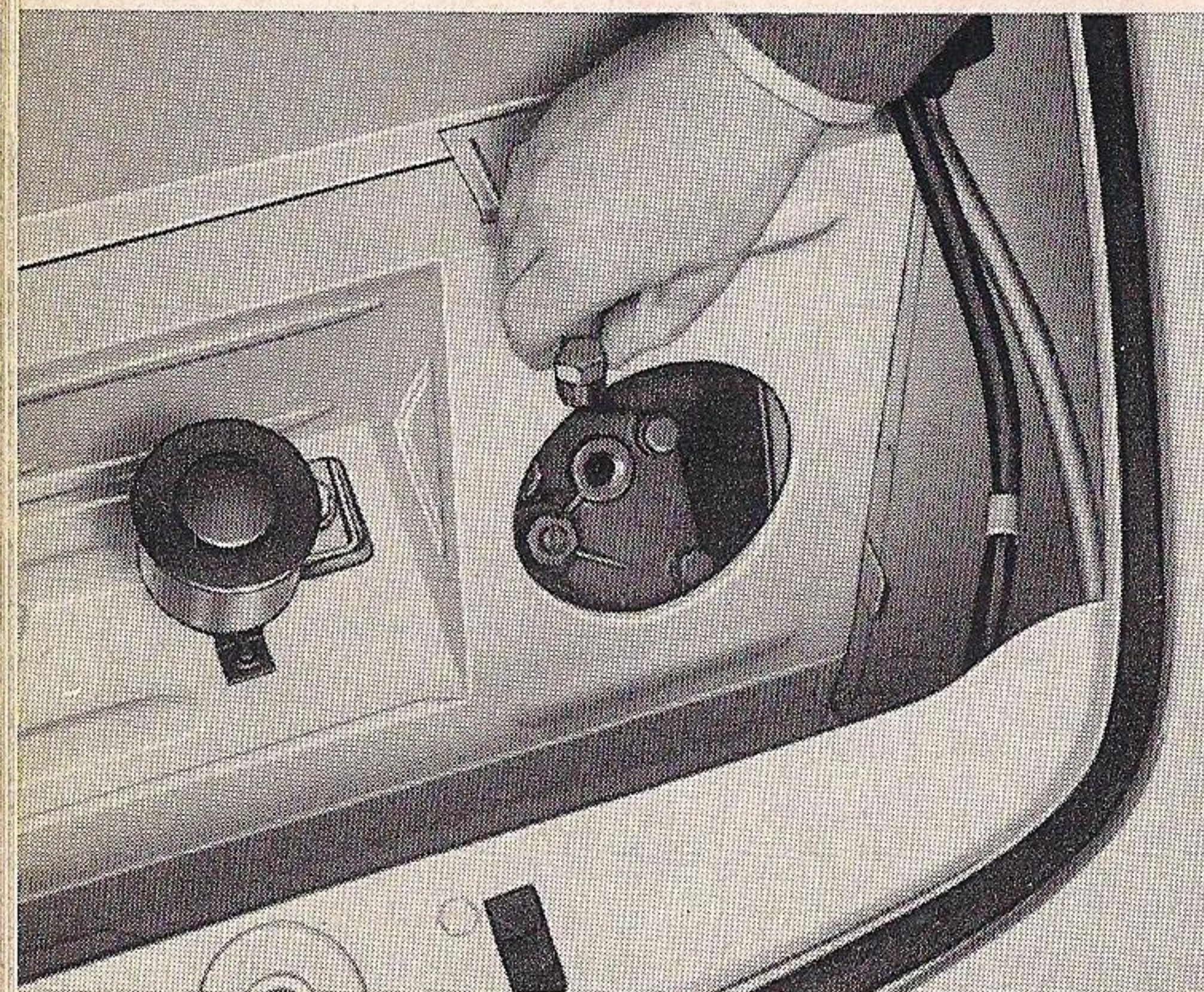

Chassis

Proper lubrication of the front axle bearing points is best done by raising the front axle so that the weight is taken off the wheels.

Prior to lubrication, the grease fittings should be cleaned thoroughly with a clean

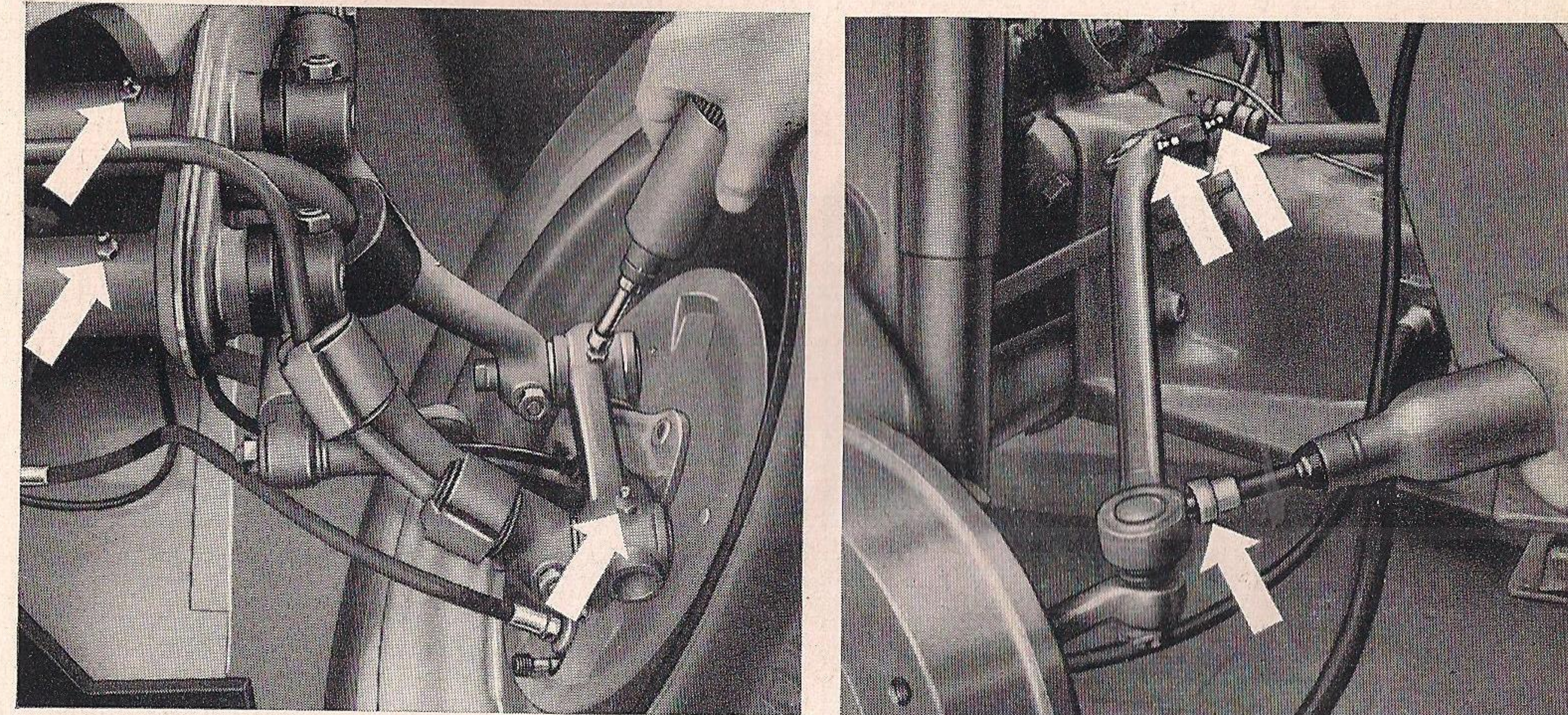

piece of cloth, so as to avoid any dirt or foreign matter entering the fittings. The tip of the grease gun should be pressed into the fitting, whereupon grease should be injected until the excess grease begins to emerge at the edges of the lubrication point.

If the car is driven mainly over rough roads, we recommend to lubricate torsion arm links and outer tie rod ends at more frequent intervals, say every 1250 km. (800 miles).

The Front Wheel Bearings

are sufficiently provided with grease at the factory. The caps on the front wheel hubs must be free from grease.

At intervals of 25 000 km. (15 000 miles), the front wheel bearings are to be cleaned and repacked with 115 gr. (4 oz.) of grease for each wheel. First fill the ball bearings and use the remaining grease for the brake drum hub. Finally, the front wheel bearings must be adjusted. This operation should, if possible, be carried out by a VW Dealer.

Doors

The door and hood hinges should be oiled, after dust and soil have been removed.

Door cylinder locks should be treated with graphite only. Blow a small quantity of powdered graphite through the key hole. Dip the key into the graphite, insert key and move it back and forth several times.

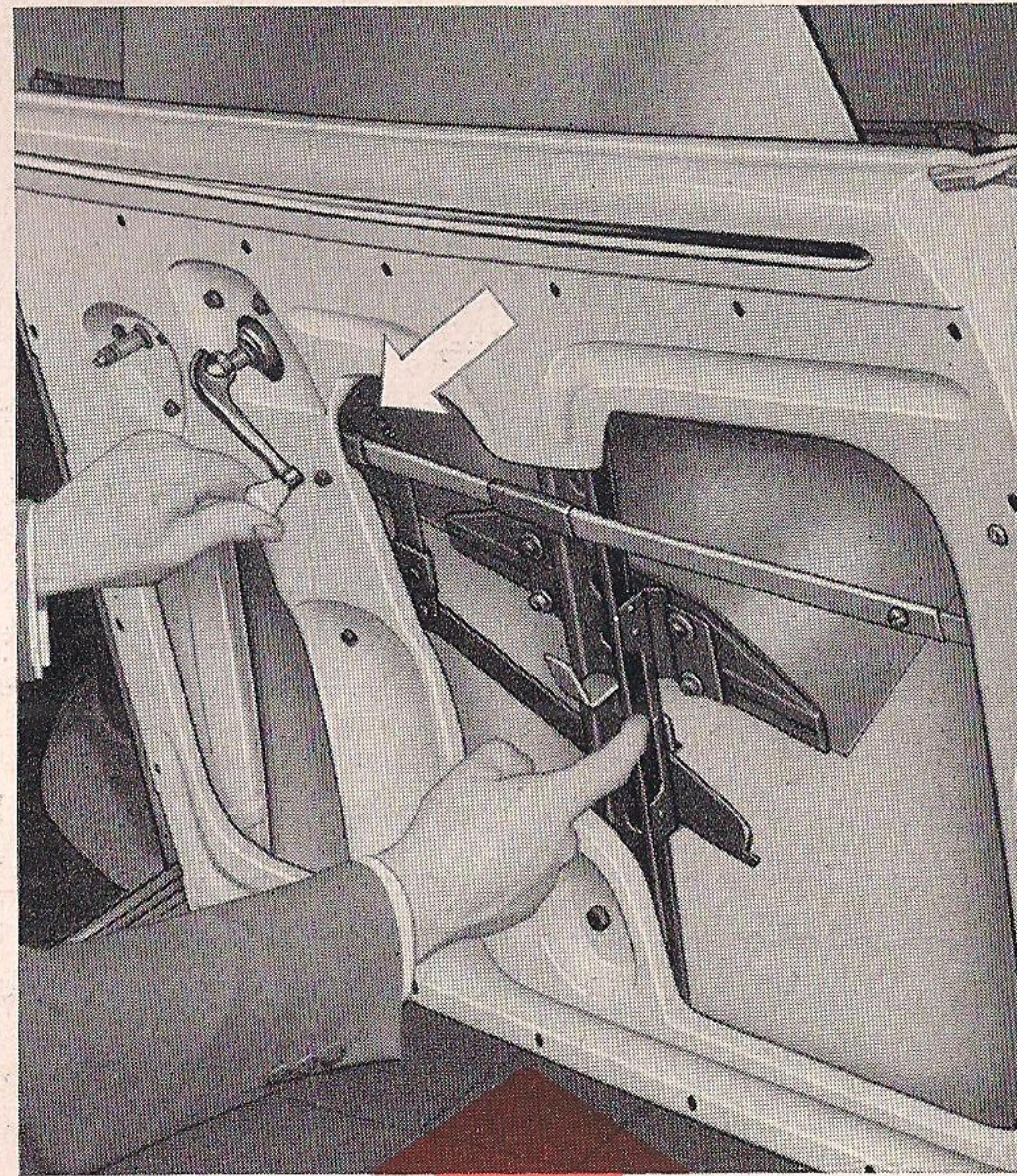
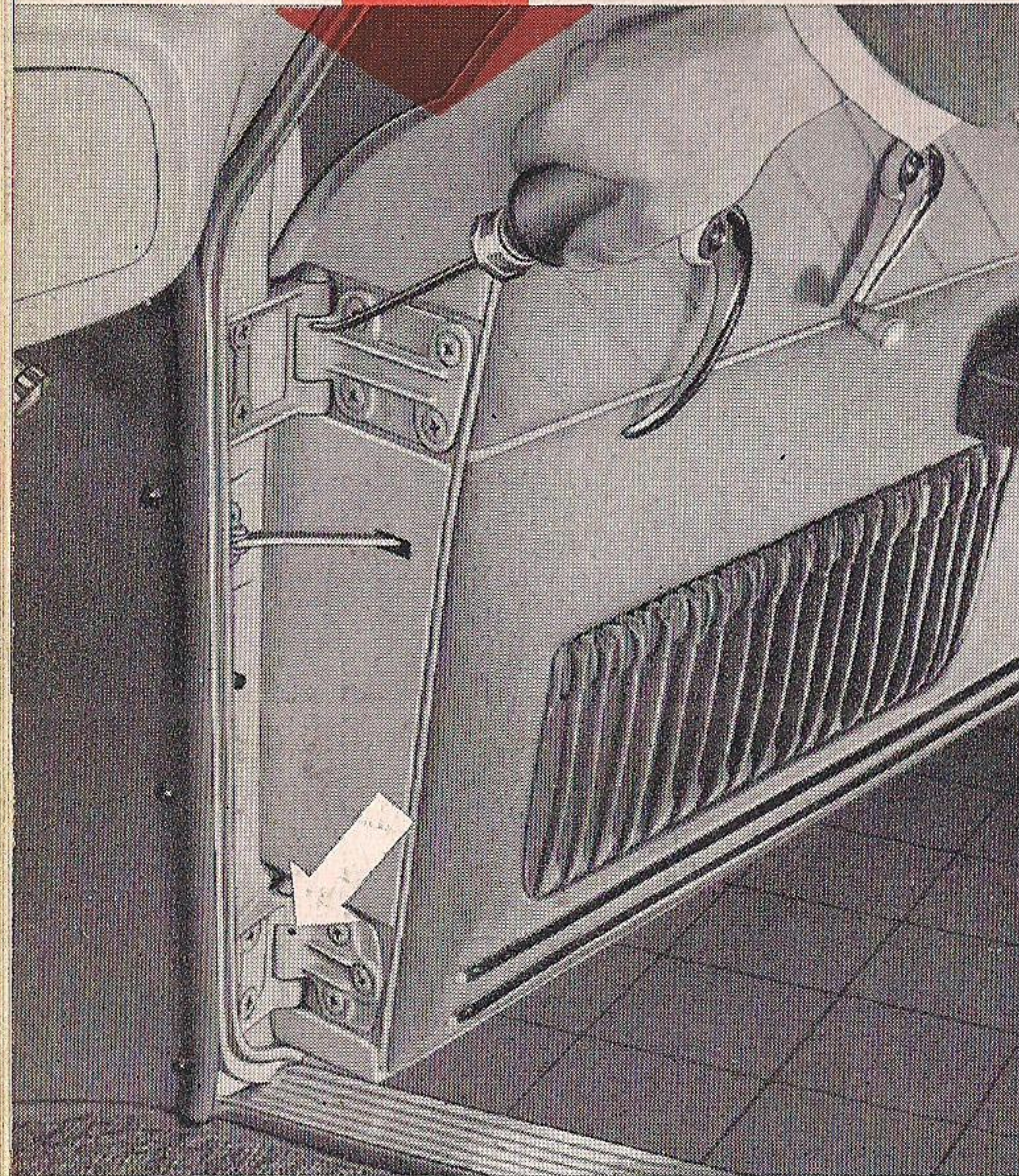

Window Regulators

The window regulator is accessible for lubrication after the handles, the trim panel and the glued-in cloth lining have been taken off. Press down the escutcheon plates, push out the pins and take off the handles. The trim panel is held by snap fasteners. Gears and joints of the window regulators should be amply greased, if found necessary after a longer period of service.

Front Seats

The upper and lower sliding surfaces of the seat runners should be provided with grease. Only a small amount of grease is required to assure easy movement of the seats. Prior to lubrication, wipe off the runners with a rag. To remove, slide the seat fully toward the front.

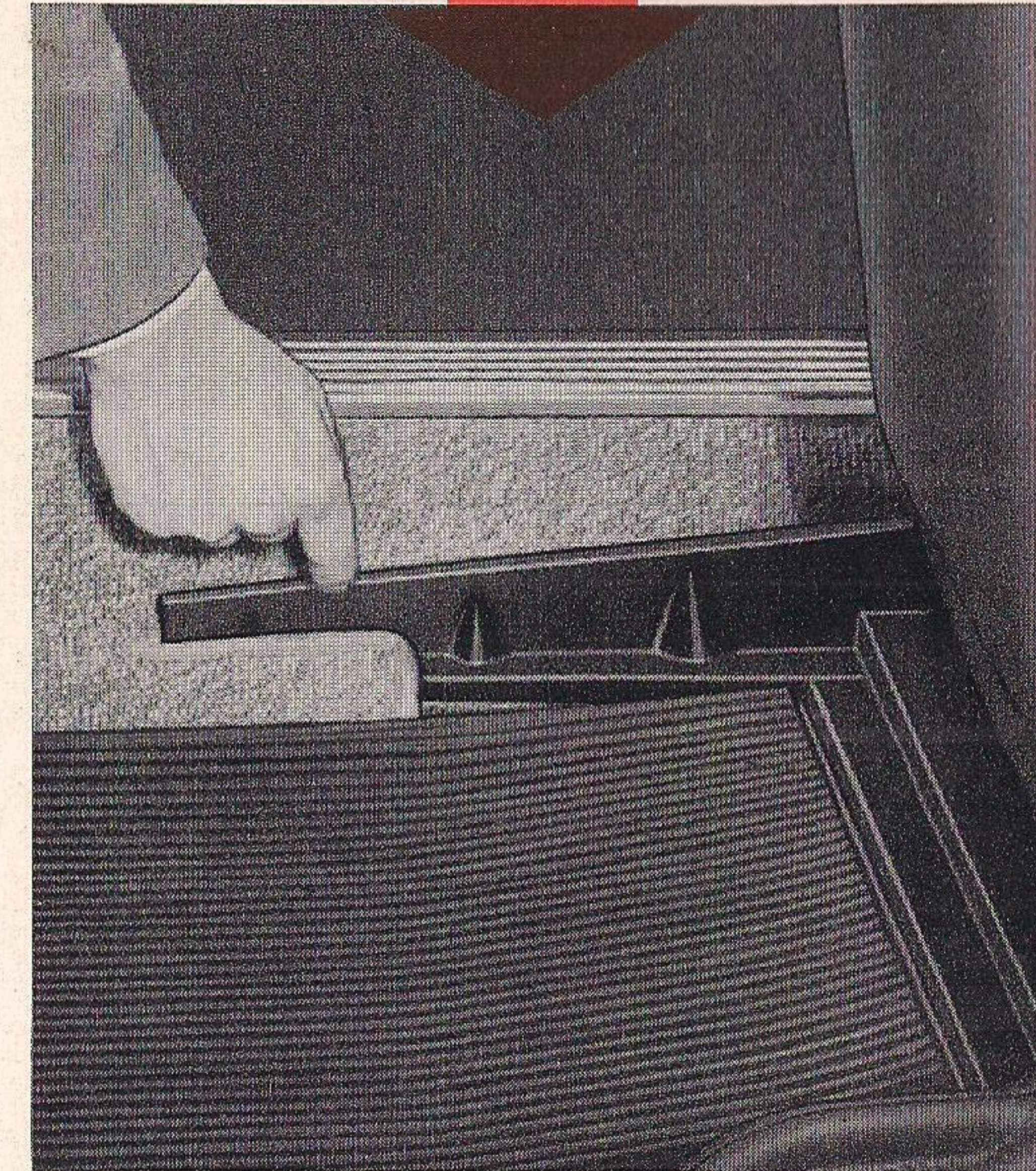

Gear Lever

Should the gear lever require lubrication, this can be done with the lever removed. Remove the two screws that attach the lever dome to the frame tunnel and lift off lever dome and spring as a unit.

The contact surfaces in lever dome, at stop plate and lever ball socket should be amply provided with universal grease. When installing stop plate, make sure that the turned-up edge is on the right-hand side.

After installation, make sure the gears engage properly. If necessary, correct position of gear lever.

WHEELS AND TIRES

Under-inflation or over-inflation are the most common causes for tire failures. High speed driving and cornering, skidding to a stop and striking curbs or objects on the road wear tires more than many miles of careful driving.

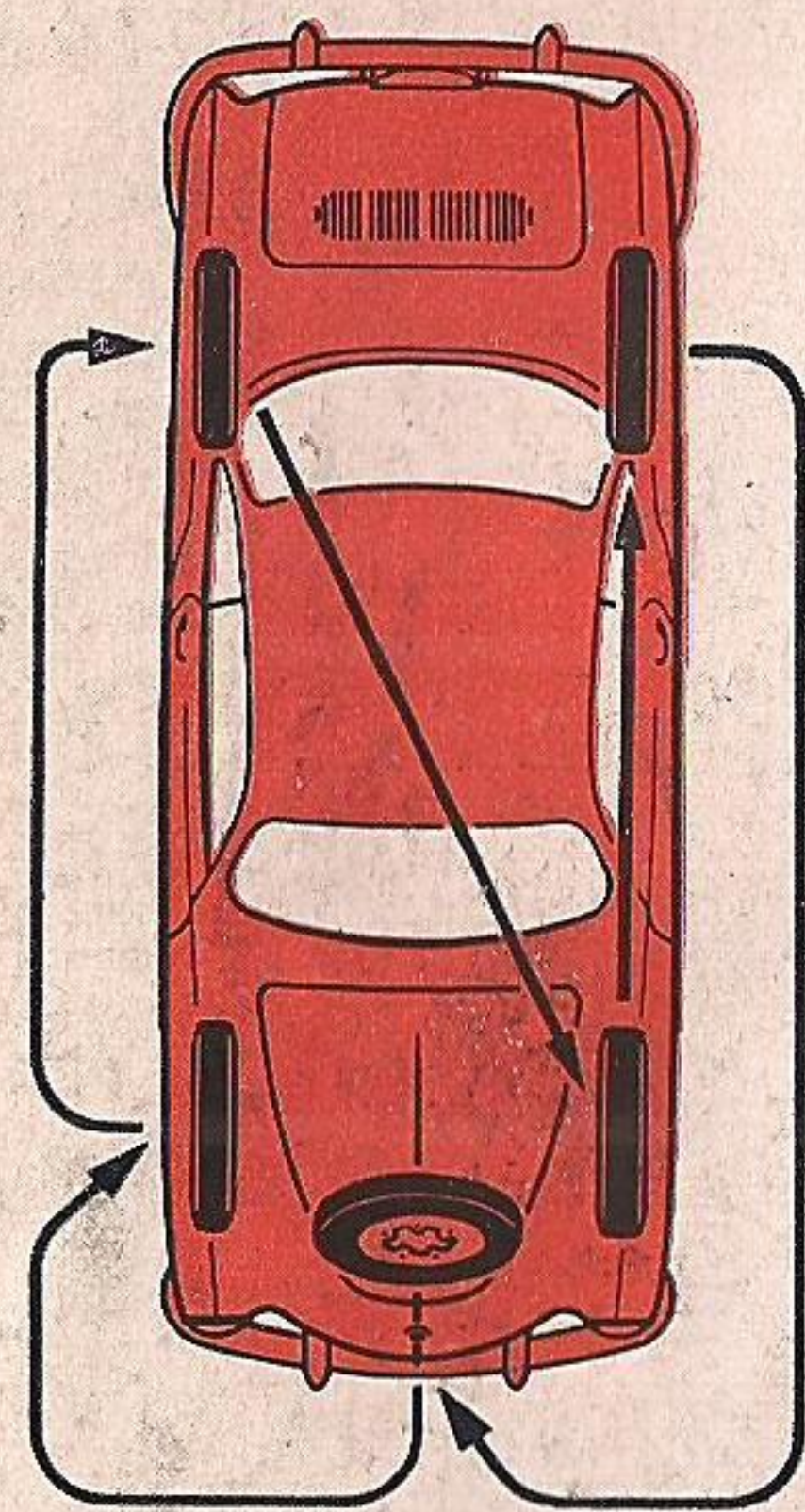

Avoid overloading the car and protect the tires from intense sunlight, fuel, or oil.

Normal wear may be kept at a minimum by interchanging wheels and tires including the spare at approximately 5000 km. (3000 miles) intervals. Rotate wheels as shown in the illustration.

A drop of oil applied to the wheel mounting bolts facilitates the next wheel change.

To obtain a smooth high speed operation and a long tire life, it is important to have the wheels balanced statically and dynamically when tubes and tires have been repaired. When the tires are being mounted, the red mark on the sidewall should be lined up with the valve to insure better balancing of tube and tire.

Changing Wheels

Changing a tire on the road certainly is not pleasant. However, it will be easier after you have read these few lines which tell you the correct way. Underneath the front hood, you will find the spare wheel, jack and tool kit.

- 1 - Set the hand brake securely and block the wheel opposite to the one being removed to prevent the car shifting off the jack.
- 2 - Grip the square bar of the jack so that the thumb comes to rest on the nose of the upper locking piece. Exert pressure on the nose and slide down the square bar until it is stopped by the base plate.
- 3 - Insert the jack into the square tube below the body sill in front of the rear wing and push down the jack base plate until it makes contact with the ground.

4 - Remove hub cap.

5 - Loosen wheel bolts by means of the socket wrench before wheel is fully jacked up.

6 - Raise jack until tire clears ground.

7 - Remove wheel bolts and take off the wheel.

8 - To install the spare wheel, operate the jack until the five holes in the wheel are nearly lined up with the holes in the brake drum.

9 - First, insert one wheel bolt only. Tighten it to such a degree as to allow the wheel to be swung around this point by hand until the remaining holes in the wheel and brake drum coincide.

10 - Insert the remaining bolts until the countersunk heads are centered in the corresponding recesses of the disc-wheel.

11 - Tighten all bolts diametrically opposite in turn.

12 - Place one end of the jack operating rod between the two noses at the point marked "ab" and apply a light pressure on the opposite end of the rod to lower the car to the ground. Keep on exerting a pressure on the operating rod to allow the base plate to be pushed up, and remove the jack.

13 - Make sure that all bolts are tight.

14 - Install hub cap and make sure that it is tightly seated.

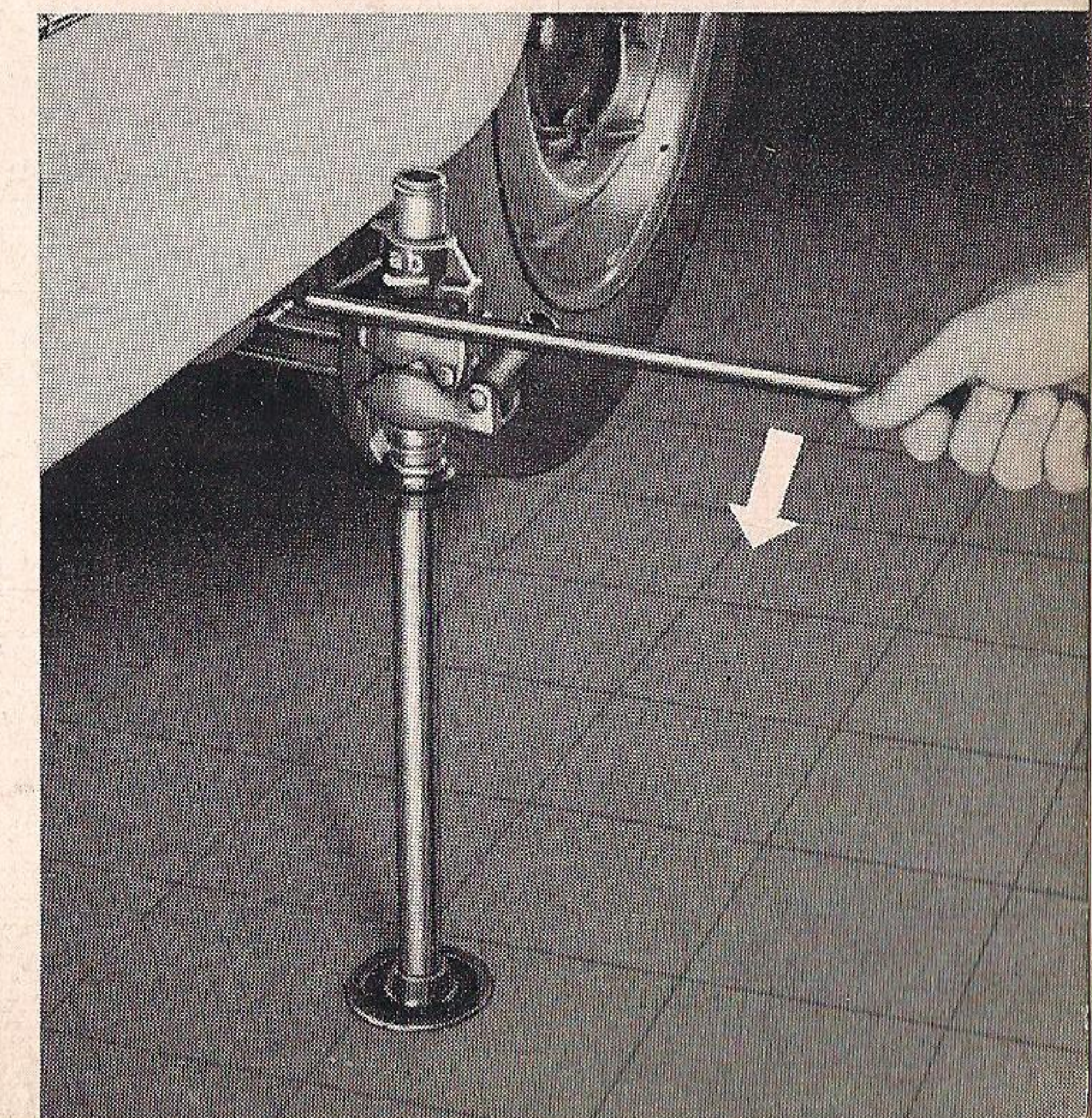
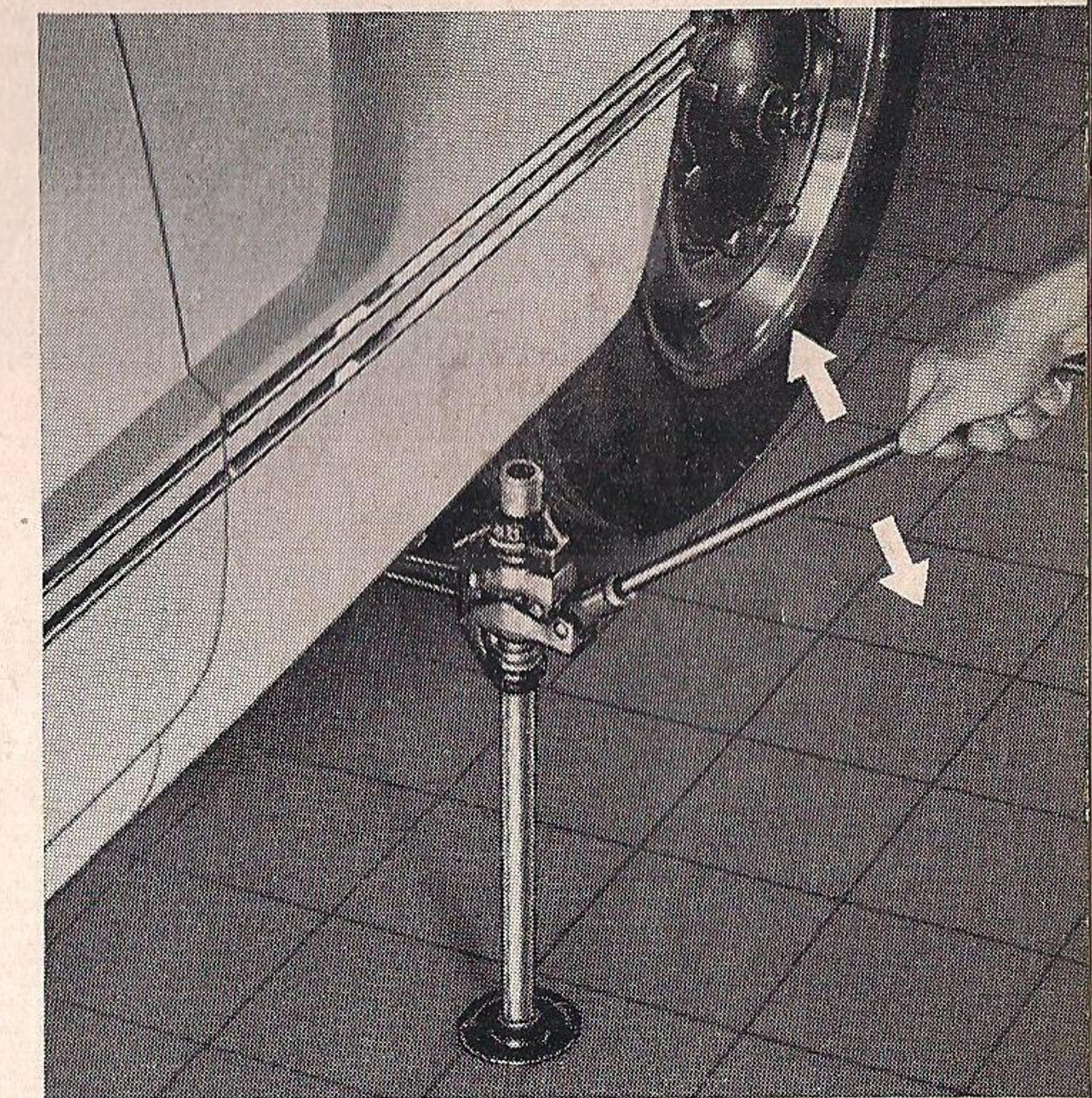
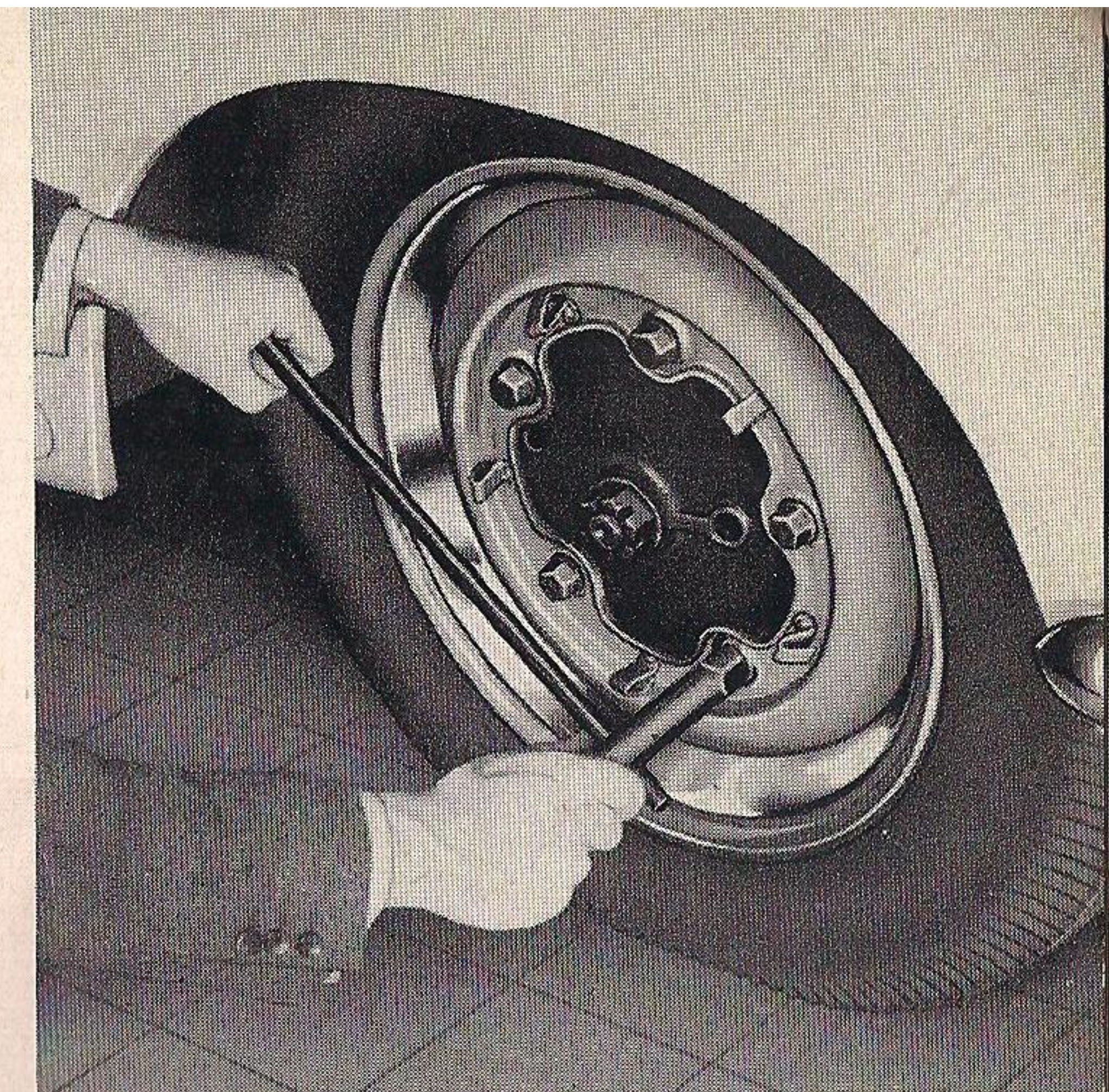

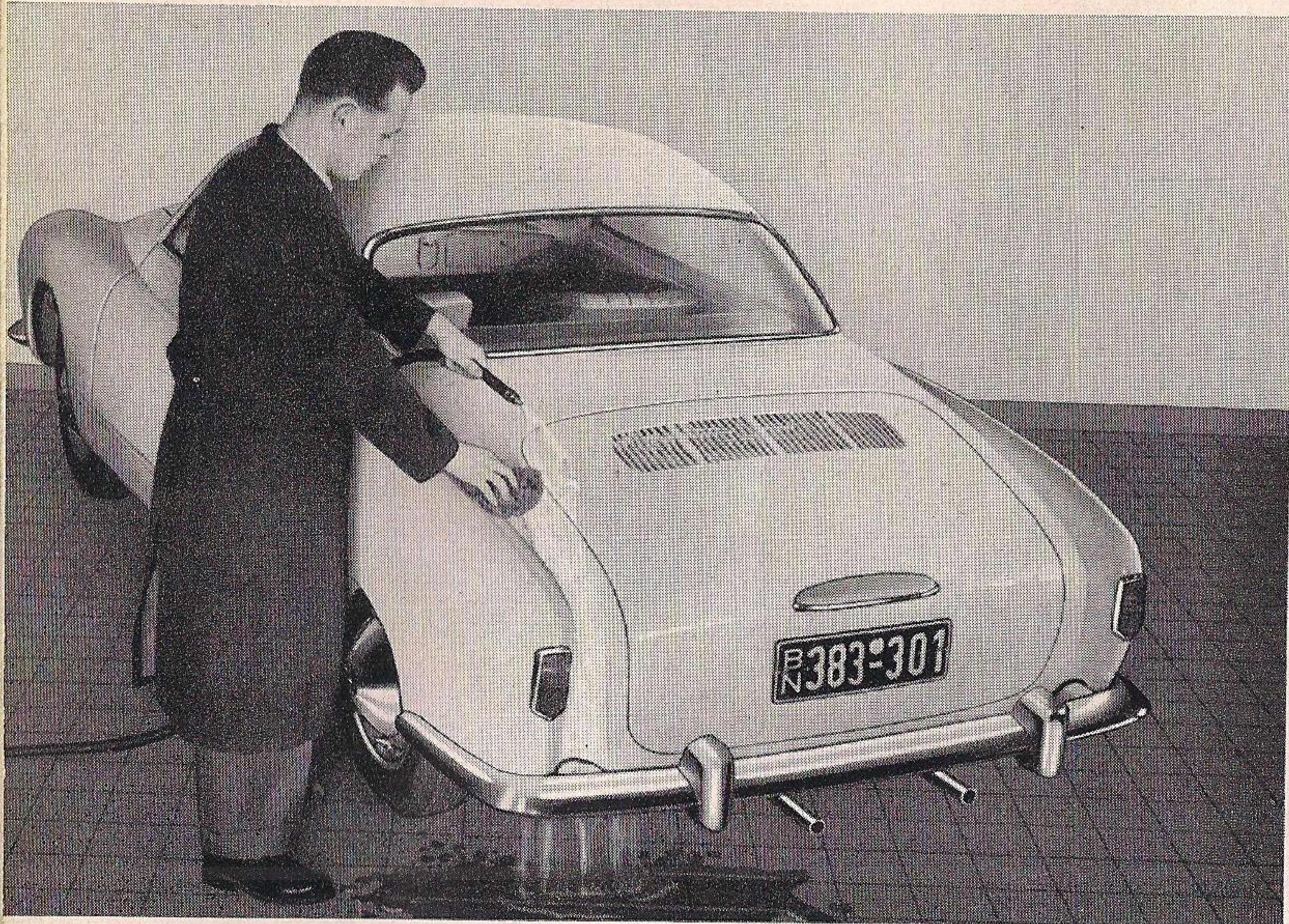

CARE OF THE CAR

Clean and Neat Appearance

To keep the car looking smart and new should be a matter of pride to the driver or owner of the car. We made it the object of our efforts to use a lasting paint finish of sparkling lustre. A chemical treatment protects the body against rust and corrosion and anchors the paint securely to the metal. The finish is of high-quality synthetic resin and carefully blended to obtain the most beautiful shades.

You will realize the importance of the paint finish if you consider that it is exposed to the elements; it has to resist sunshine, rain, dust, and dirt. That is why a periodic care of the body is necessary to retard any disintegrating process.

Washing Your Car

Wash your new car frequently during the first weeks. This practice will be of great advantage to the finish. For washing your car you require a soft sponge for the body, a soft brush for the wheels, a sturdy, long-handled brush for the chassis, and plenty of clear water! For drying the car you need a chamois.

The chassis and lower part of the body should first be flushed with water, to soak off the dirt, and afterward a brush should be used.

Apply an even spray of water on the exterior finish of body and wheels until dirt is soaked off. Do not allow a hard shot of water to hit the varnished surface. Using plenty of clear water, dirt should be removed with a sponge. Care should be taken to clean the sponge at short intervals so as to avoid scratches on polished parts. There are some approved auto soaps and detergents which greatly facilitate this job. Avoid the use of any product which has not been recommended by your VW Dealer. It is of utmost importance to rinse the body thoroughly with water after the car-wash has been applied to insure that no traces of it remain on the body.

After washing, rub down with a clean chamois to prevent water spots. Some cleaners even render the rubbing down unnecessary and it is sufficient to remove traces of water.

Preservation (Waxing)

means to restore to the finish certain substances it has lost by exposure to the weather. As these substances are vitally important to the elasticity of the finish, it is necessary to apply a protective water-repellent coat of wax to the body. The intensive cleaning effect of the shampoo removes this protective coating so that it should be renewed accordingly. A preservative specially produced for the finish of your car can be obtained under the designation „L 190“ from your VW Dealer.

The body should be waxed after the first eight or ten weeks and then regularly at intervals of from six to eight weeks — in any case after each soap or detergent washing, as already mentioned. Applying the preservative is quite easy: With a soft cloth, spread a thin film on the finish, then rub it down when dry (after about 20 minutes), using polishing cotton or a soft polishing cloth, until iridescent colors can no longer be seen when standing at an angle to the polished area.

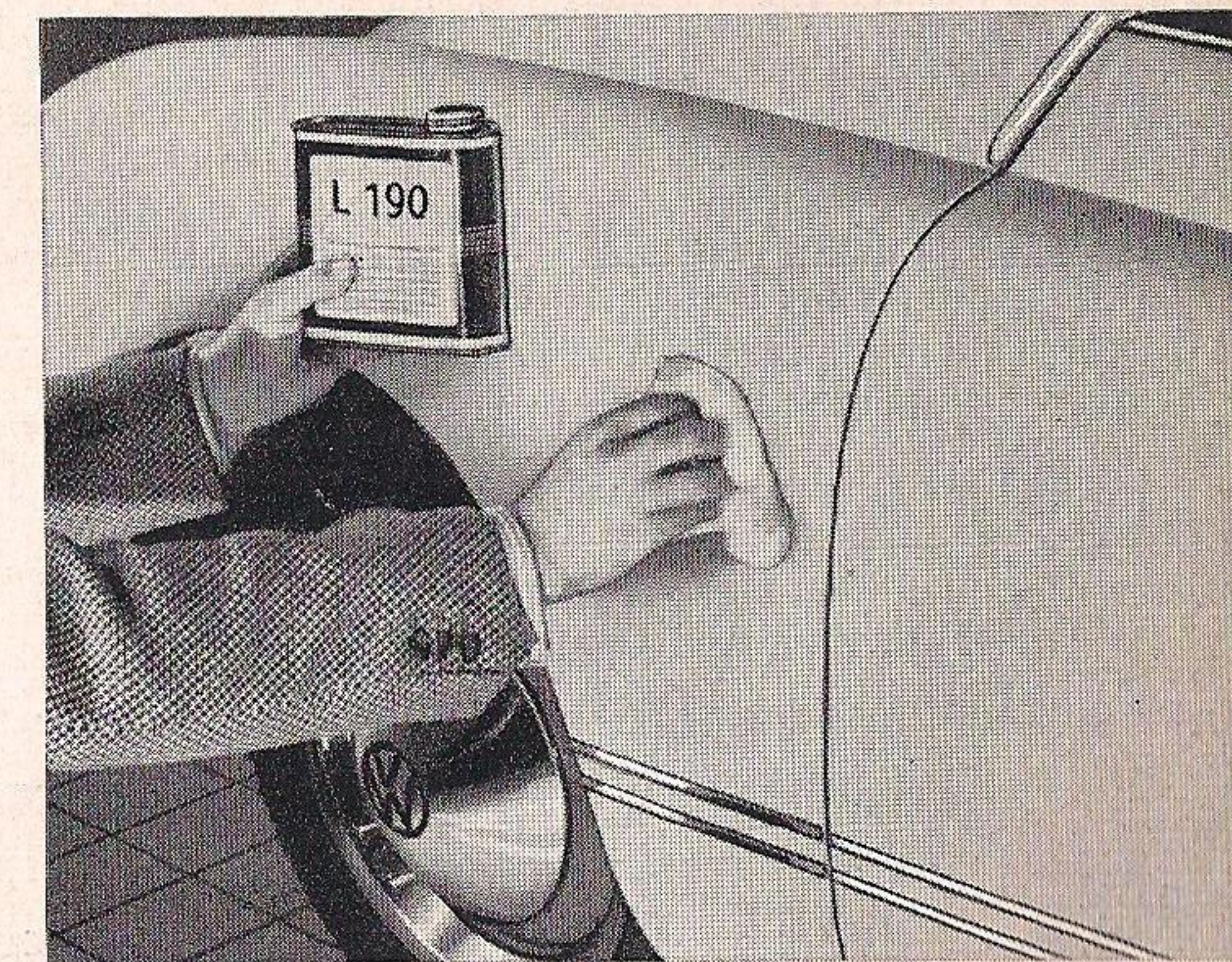

Polishing

You should polish your car only if its appearance has been strongly affected by road dust, sunlight and rain as a consequence of insufficient care, and if the application of the preservative no longer restores the original lustre. Avoid the use of abrasives or chemically harmful products, even if their first application seems to give satisfactory results. A special polish for treating the synthetic-resin finish is also obtainable from your VW Dealer under the designation "L 170".

Prior to applying the polish, the car must be washed and dried carefully. Dust or soil should never be wiped off dry. The polish should be applied with a soft and clean cloth or polishing cotton — use a straight horizontal or vertical motion rather than a circular motion. After some time of rubbing you will feel a slight resistance, which indicates that the ingredients of the polish have settled in the finish and that the solvent has evaporated. Now take clean polishing cotton and rub the body down until the high polish is restored. Do not apply the polish on too large an area of the body at a time. A subsequent application of the preservative gives you care-free pride in your car for a long time.

Never wash or polish the car in sunlight or when the metal is warm.

How to Remove Spots

By a mere washing you cannot always remove splashes of tar, oil traces, "baked on" insects, etc. As a matter of principle, such foreign matter should be removed as soon as possible, for if you neglect this rule, permanent damage may result to the finish.

Tar Spots

An unpleasant sight, to be noticed particularly on light-colored cars, are tiny tar spots which show up on the wings on hot days when driving on newly tarred roads. Tar splashes have a tendency to corrode the finish within a short time and should be removed immediately when discovered. On the way, you usually have nothing at your disposal but fuel, which may be applied with a soft cloth. Kerosene or turpentine oil may also be used. After this, the treated spots should be washed with a mild, lukewarm soap-solution, and rinsed, in order to remove traces of the cleansing agent. It is, however, better to use the preservative already mentioned, which renders the treatment with soap-solution unnecessary.

Insects

are caught especially during the night, in hot weather, by the forward-facing parts of the car. Once baked on they can hardly be removed with water and sponge, but should be treated with lukewarm soap-solution.

Blooming trees

but more especially lime-trees, in many instances drop tiny quantities of liquids. Cars that have been parked underneath such trees become "freckled" all over. These stains, too, can be readily taken off with soap-solution.

A treatment of the cleaned spots with the preservative is strongly recommended.

Chromium-Plated Parts

should be lightly coated with chromium wax. The use of grease or vaseline is not recommended, as these will bind dust and dirt.

Care of Imitation Leather Upholstery

It is recommended to clean the artificial leather upholstery with a soft cloth or a soft brush. Special care should be taken to remove dust and dirt also from the upholstery seams. A better cleaning effect is obtained by the use of a soft whisk broom and a suds of lukewarm water (rain water, boiled or soft water) and any mild soap (castile or olive oil base soaps). Use the water sparingly, the upholstery otherwise requires a long time to dry, if water trickles through the seam stitches. After completing the cleaning operation, use a clean, soft cloth to polish the surface of the leather. Carefully treat the upholstery seams. Never use furniture polishes, oils, varnishes or cleaners on imitation leather upholsteries. They will injure the finish.

Care of Leather Upholstery

The leather upholstery should be serviced in accordance with the instructions given for the imitation leather upholstery. After the upholstery has been wiped dry, an accredited cleaner may be used to clean, preserve and brighten the appearance.

Cleaning Glass

Windows can be cleaned by washing with water and wiping dry with a clean, soft linen cloth or chamois. In order to facilitate this task on the windshield the arms of the windshield wipers may be tilted forward. To clean unusually dirty windows, use alcohol or household ammonia and lukewarm water.

Door and Window Weather Strips

To assure a perfect door and window seal, it is important to keep the rubber parts undamaged and supple. To retain the original flexibility and to reduce friction, it is recommended to apply a light coating of powdered talc to all rubber parts from time to time.

Airing the Interior

If the car is left stationary for a longer period in your garage, attention should be paid to the airing conditions. Permit air to circulate freely through the body by opening the doors and lowering the windows to prevent a forming of mould and damp-stains.

MAINTENANCE

In the case you can't get to an Authorized VW Dealer in time, we are giving you some information which, if needed, will help you to carry out normal maintenance work. However, repair jobs which are beyond your capacity should be entrusted to VW workshops. There your car will be given expert treatment by those familiar with its construction.

This will save you time, inconvenience, and money.

Servicing Air Cleaner

The air cleaner filters particles of dirt and grit from the air used for combustion. Regular servicing at intervals of 5000 km. (3000 miles) is especially important in dusty areas. A dirty air cleaner is responsible for frictional wear, decreasing operating efficiency, and increasing fuel consumption.

To service air cleaner, remove it from the intake elbow and take off the

upper half that houses the filter element. Remove dirty oil from reservoir and refill to indicated level with 0.25 liter (0.5 pint) of SAE 20 engine oil. Rinse the filter element in kerosene or any other degreasing fluid and allow the fluid to drain from the filter. As a general rule, the cleaner oil level should be checked in conjunction with the engine oil level (every 2500 km./1500 miles). When adding oil, be sure the level in the fluid reservoir does not rise above the mark.

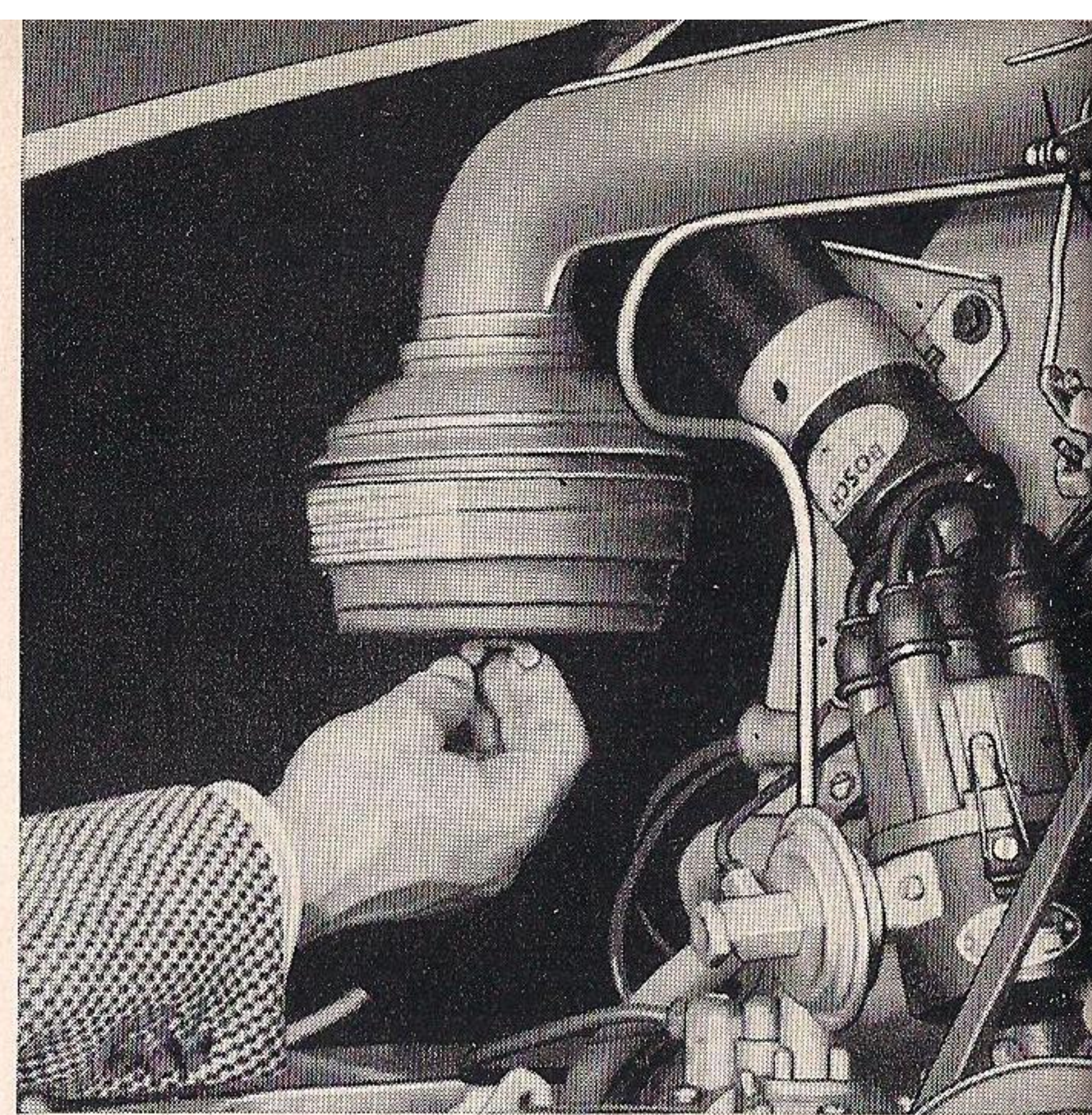

If the car is mainly operating under desert or other extreme conditions of dust-laden atmosphere, it is up to you to prevent premature wear by more frequently servicing the air cleaner than specified above.

Air cleaner service is overdue, if there is no thin oil above the sludge and dirt that has accumulated in the fluid reservoir.

Adjusting the Fan Belt

To adjust the fan belt, remove nut and outer half of generator pulley. When loosening or tightening nut, insert a screwdriver in the slot cut into the inner half of the pulley, and support it against upper generator housing bolt.

The adjustment of the fan belt tension is effected by means of spacer washers situated between the two pulley halves. Belt slackness is taken up by removing one or more washers. If the belt is in too much tension, one or more washers should be added.

The fan belt should not be too slack, nor should it be too tight. Newly installed belts will stretch to

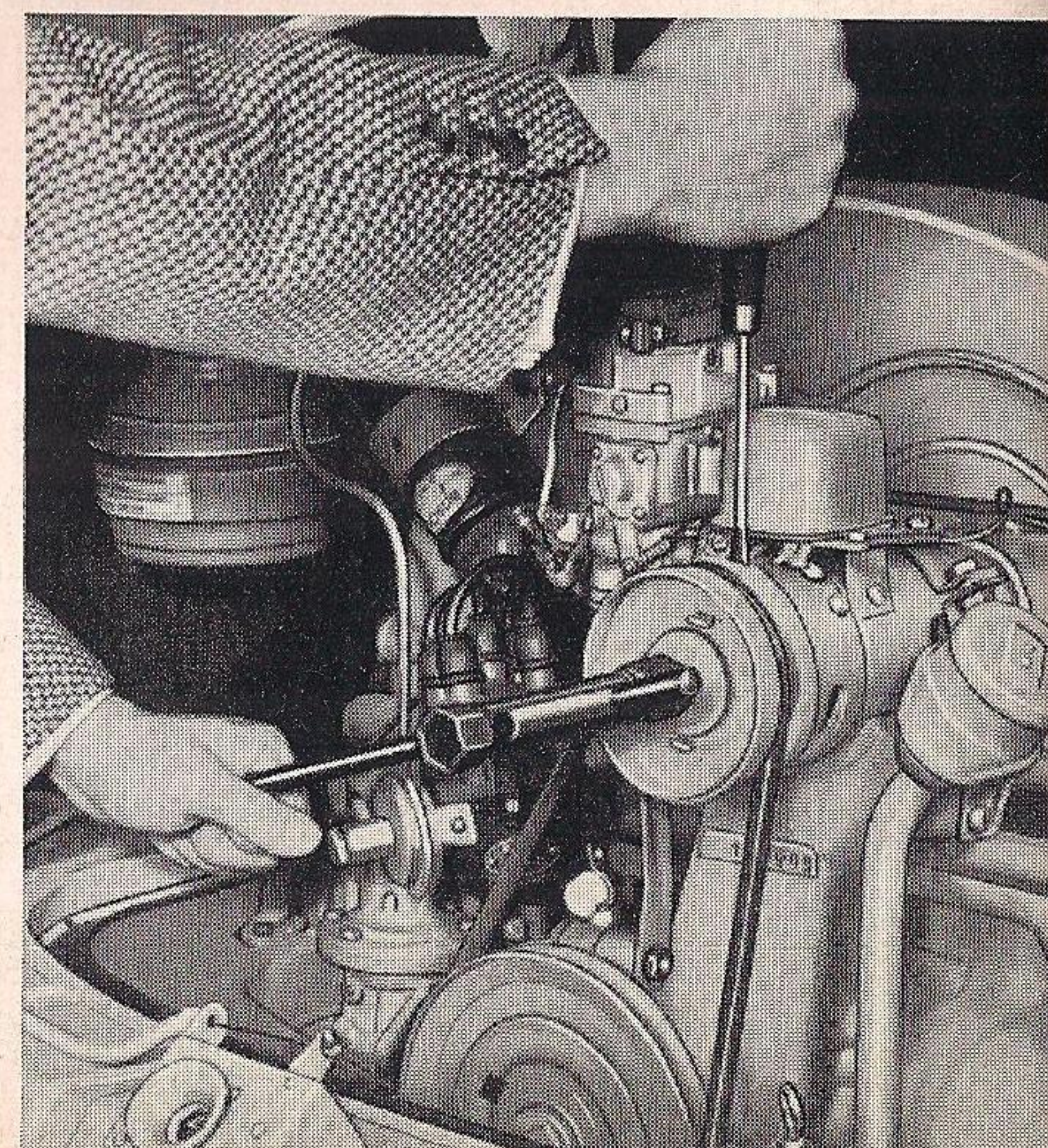

some extent and should, therefore, be checked and adjusted after 50 or 100 kilometers (30 or 60 miles) of running.

Cleaning the Carburetor

To clean the carburetor, it is sufficient to tilt back the bowl cover.

Bowl Cover Removal

- 1 - Remove the air cleaner.
- 2 - Disconnect the fuel line at the carburetor.
- 3 - Remove the screws that attach the cover to the carburetor bowl.
- 4 - Lift the carburetor bowl cover and tilt it back. For the complete removal of the carburetor bowl cover, the choke control cable and the throttle connector rod must be disconnected.

To reassemble the unit, proceed in reverse order. Install a new gasket and be sure of its proper position between bowl and bowl cover.

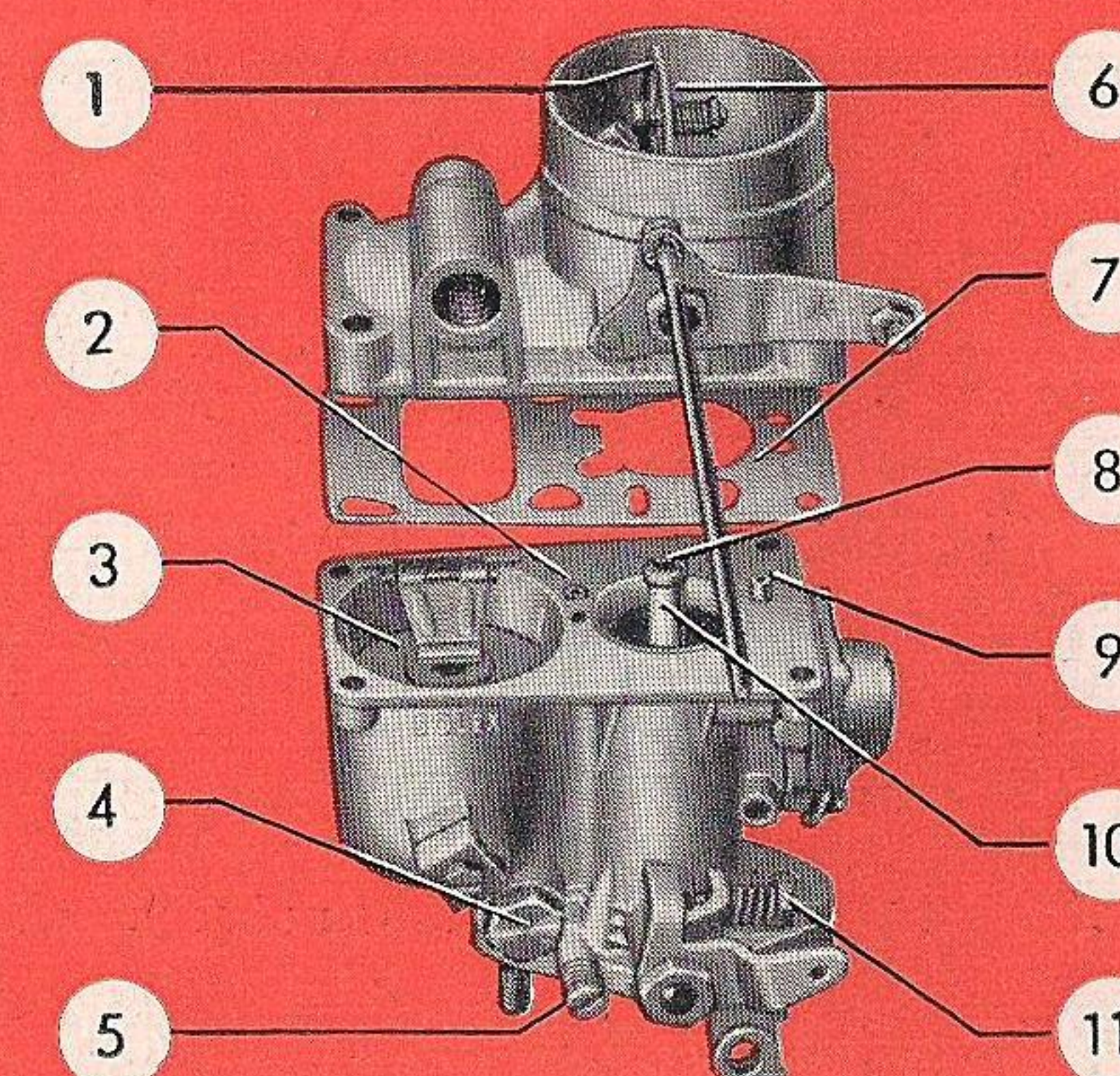
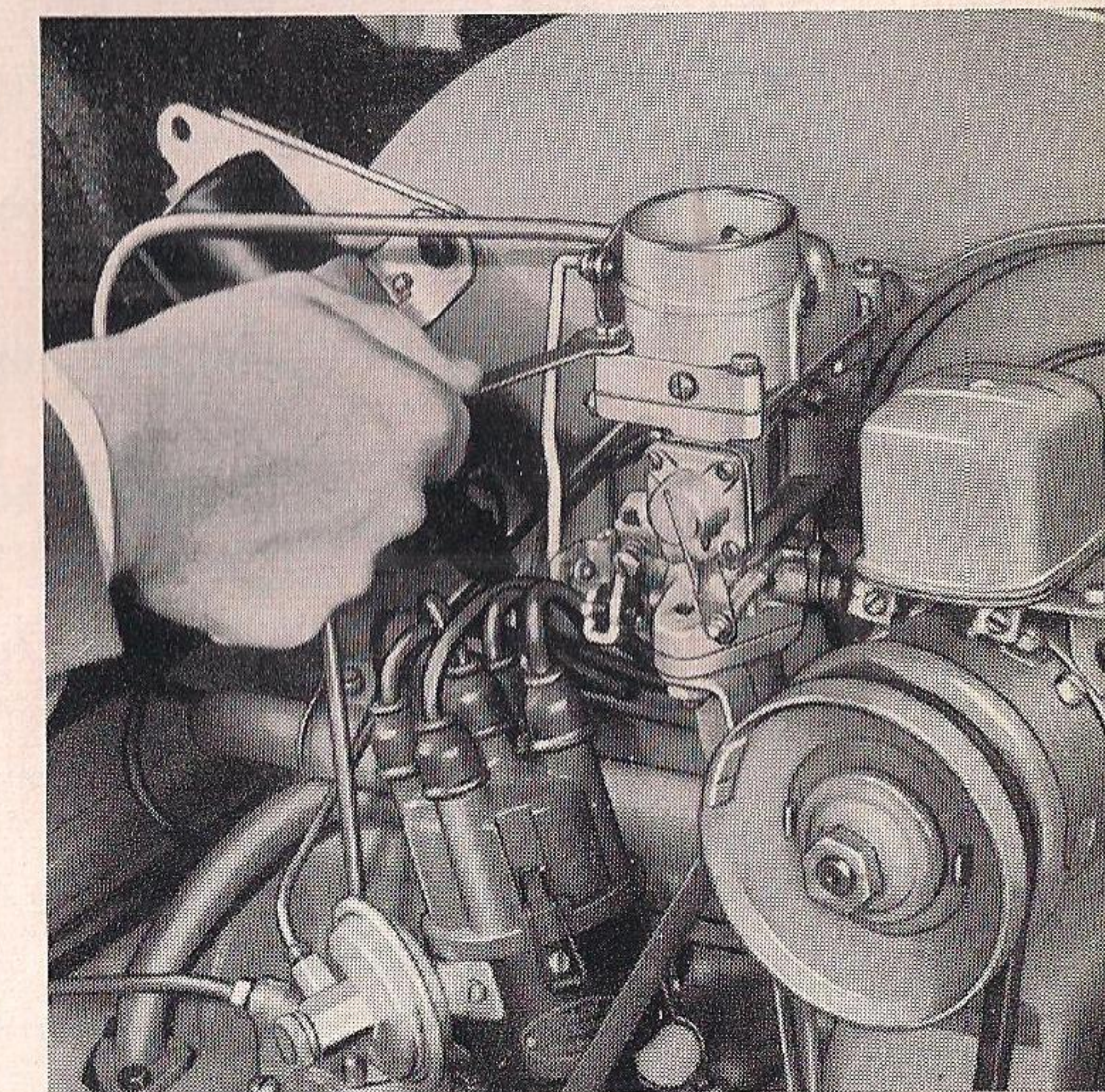
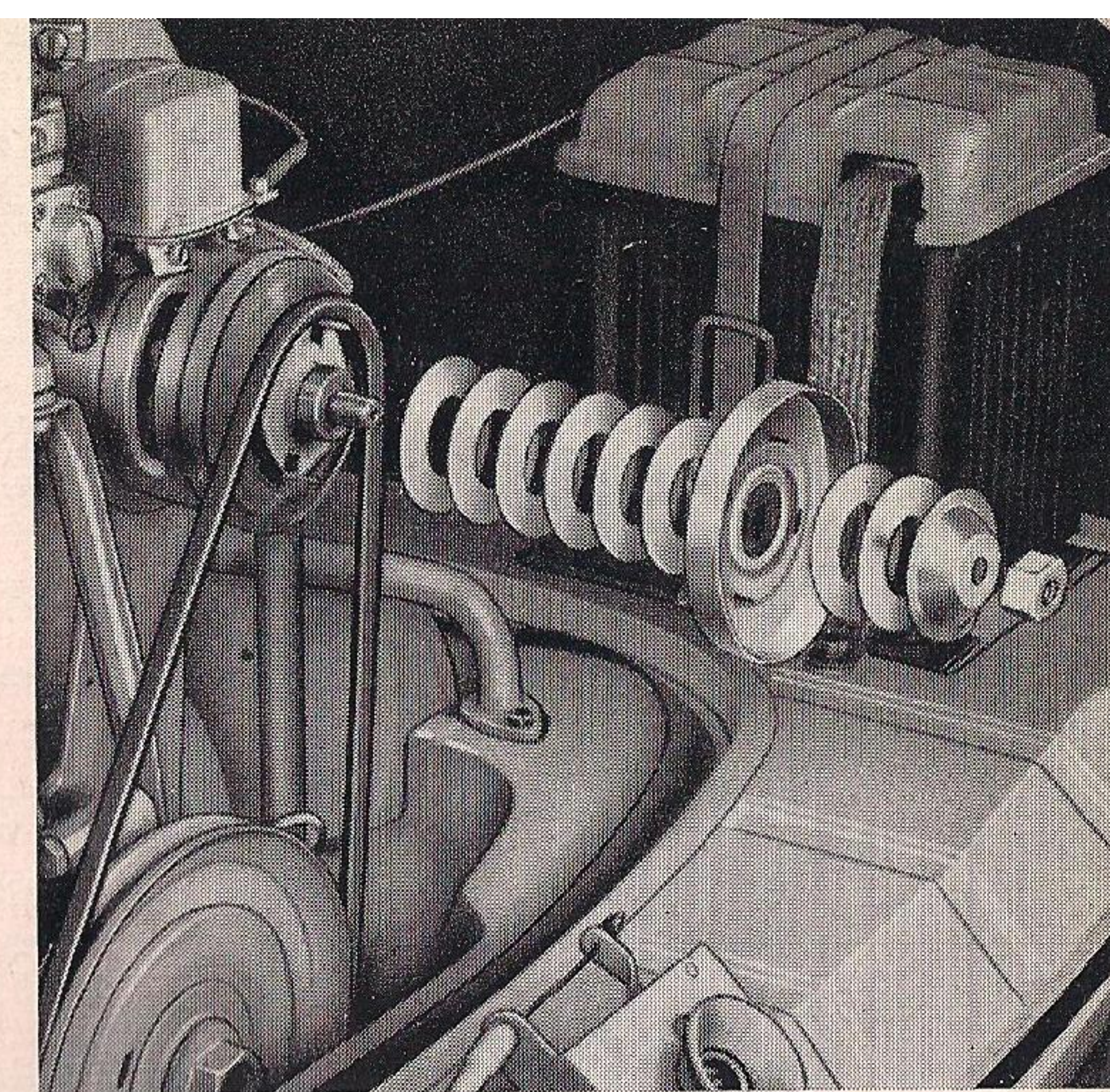

- 1 - Choke,
- 2 - Pilot jet air bleed,
- 3 - Float,
- 4 - Main jet,

- 5 - Volume control screw,
- 6 - Poppet valve,
- 7 - Gasket,
- 8 - Air correction jet,

- 9 - Pump pipe fitting,
- 10 - Emulsion tube,
- 11 - Idle adjusting screw,
- 12 - Accelerator pump,

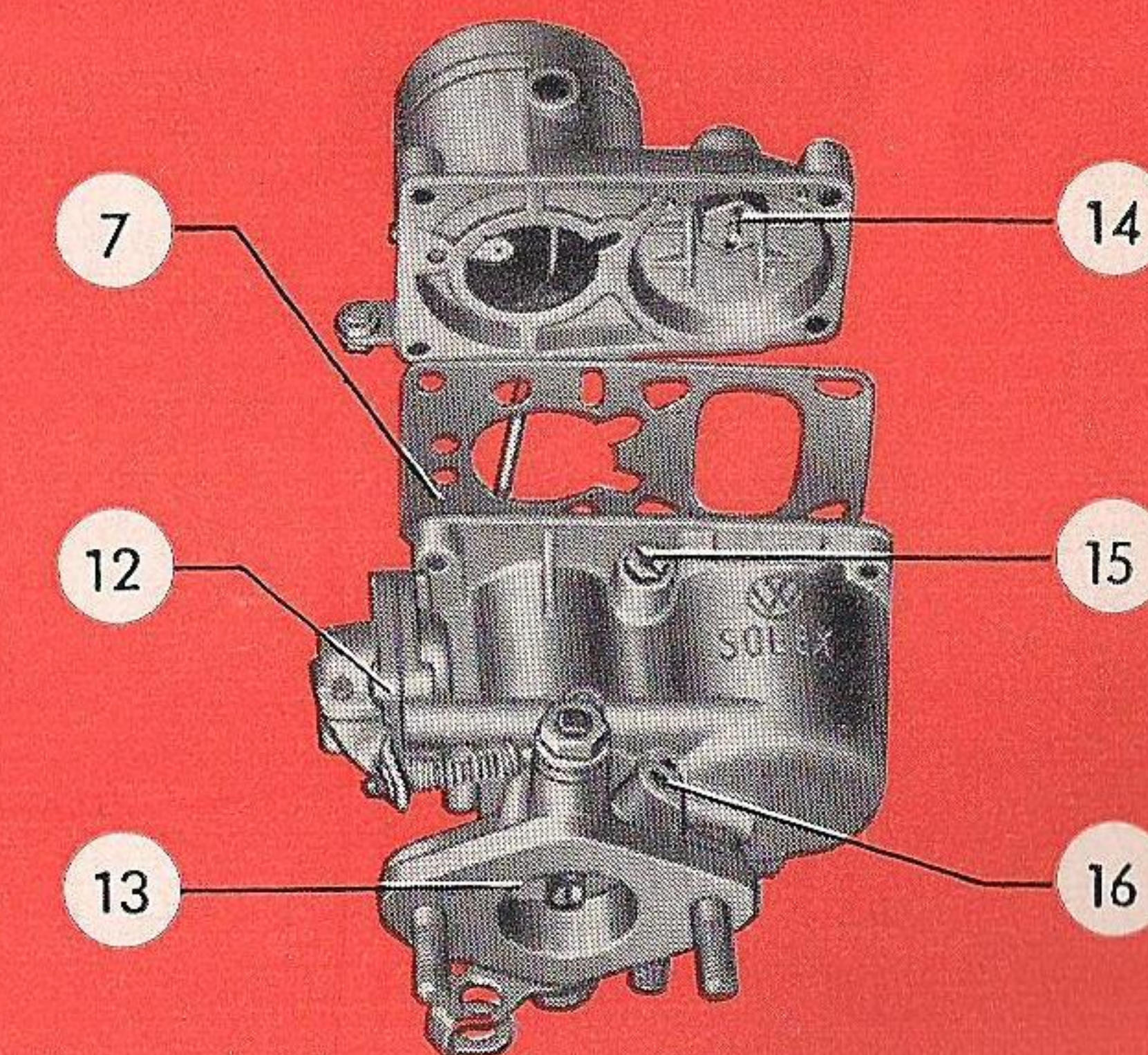

- 13 - Throttle,
- 14 - Float needle valve,
- 15 - Pilot jet,
- 16 - Vacuum tube connection

Cleaning

- 1 - Remove float.
- 2 - Remove the main jet plug and clean main jet and float bowl.
- 3 - Clean pilot jet air bleed.
- 4 - Clean pilot jet.
- 5 - Clean air correction jet and emulsion tube.
- 6 - Clean float needle valve.
- 7 - Clean accelerator pump discharge passage.
- 8 - Clean passage from float bowl to accelerator pump.

Blow out the jets and passages with compressed air. Never use a pin or a piece of wire, as such practice will lead to damage.

Adjustment

The carburetor is tested at the factory and properly adjusted to the engine. Do not alter this adjustment by exchanging the jets or the venturi for other than the prescribed sizes. This would be detrimental under normal operating conditions and may result in hard starting, excessive fuel consumption or unsatisfactory engine performance.

Only the idling of the engine may call for a readjustment occasionally.

Before attempting to adjust the carburetor, make sure the engine is at normal operating temperature.

- 1 - Turn the volume control screw in until it seats lightly, then back it off approximately $\frac{3}{4}$ turn.
- 2 - Turn the idling adjusting screw in or out until the approximate idling speed is attained.
- 3 - Gradually turn in the volume control screw until the position is found where the engine just tends to stall, then back it off by $\frac{1}{4}$ turn.
- 4 - Finally re-adjust the idling adjusting screw until the engine runs at normal idling speed.

The adjustment is perfect if the engine does not stall after the throttle either is suddenly opened or suddenly shut with the clutch pedal depressed. Poor idling may also be the result of damaged gaskets, intake manifold flanges not sufficiently tightened, faulty ignition or leaky valves. Skilled hands and experience are required to check and adjust the carburetor and the accelerator pump. For this reason you should leave this job to an Authorised VW Dealer.

Valve Adjustment

Proper adjustment of the valve clearance is important to prevent burning of valves and poor engine performance.

The following procedure should be carried out only in such emergencies when it is impossible for you to reach a VW Dealer.

Valve clearance should be 0.10 mm. (.004") with the engine cold. The valve clearance increases when the engine warms up. For this reason,

only adjust valve clearance when the engine is cold.

The arrangement of the cylinders can be seen by the numbers 1 to 4 indented in the cover plates.

Valve adjustment may be made in the following sequence: 1st - 2nd - 3rd - 4th cylinder.

Adjust the valves when the piston of the corresponding cylinder is in top dead center position of the compression stroke. Starting with the 1st cylinder, crank the engine over slowly to the left by the fan pulley, until both valves are in fully closed position and the timing mark on the pulley is in line with the vertical jointing faces of the crankcase.

If the clearance requires adjustment, loosen the lock nut of the adjusting screw and turn the adjusting screw as required to obtain the proper clearance. Tighten the lock nut and recheck the clearance. Readjust if necessary. Check and adjust the other valves to the proper clearance in this manner by turning the crankshaft anti-clockwise another 180° for each cylinder.

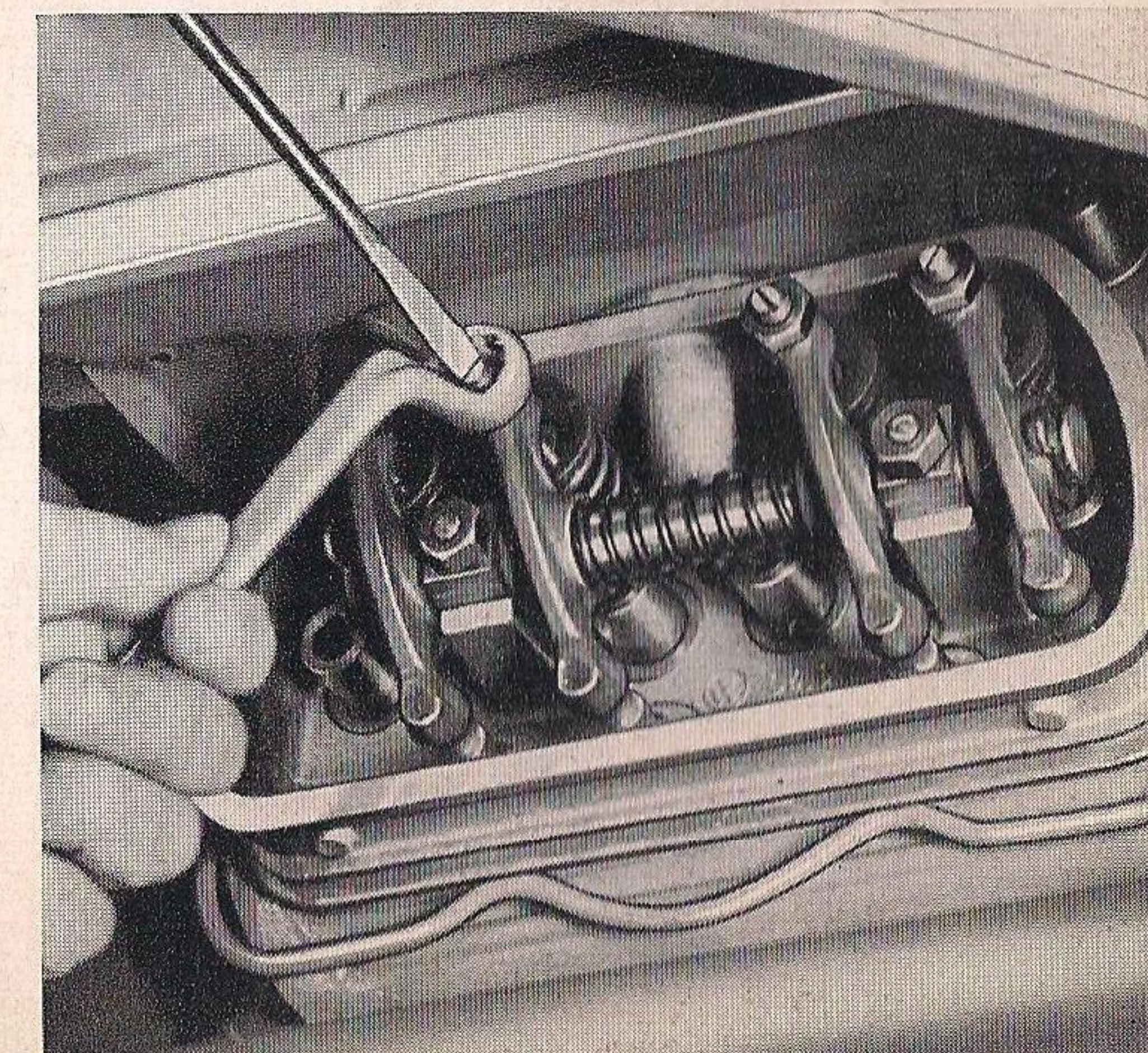
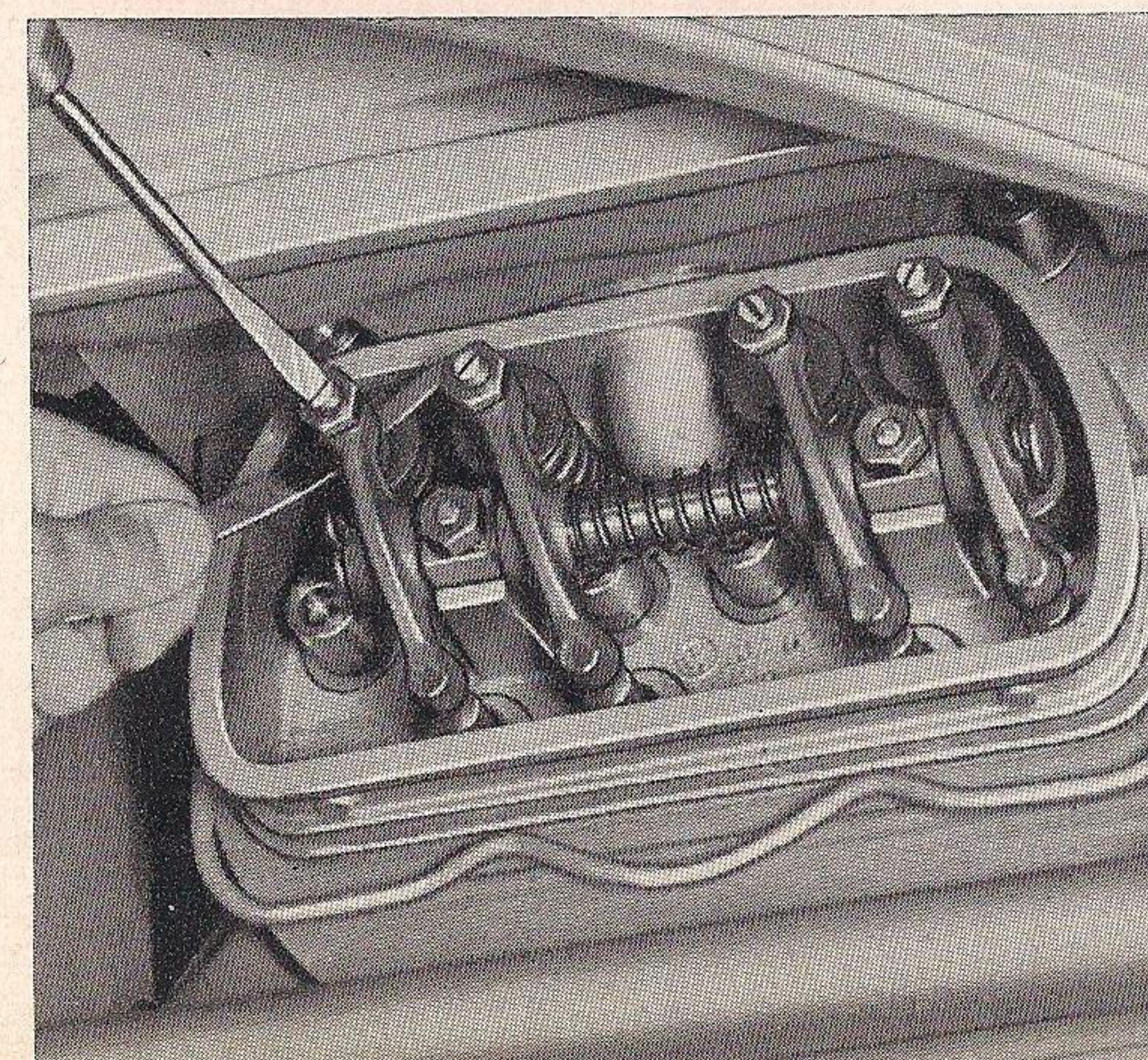
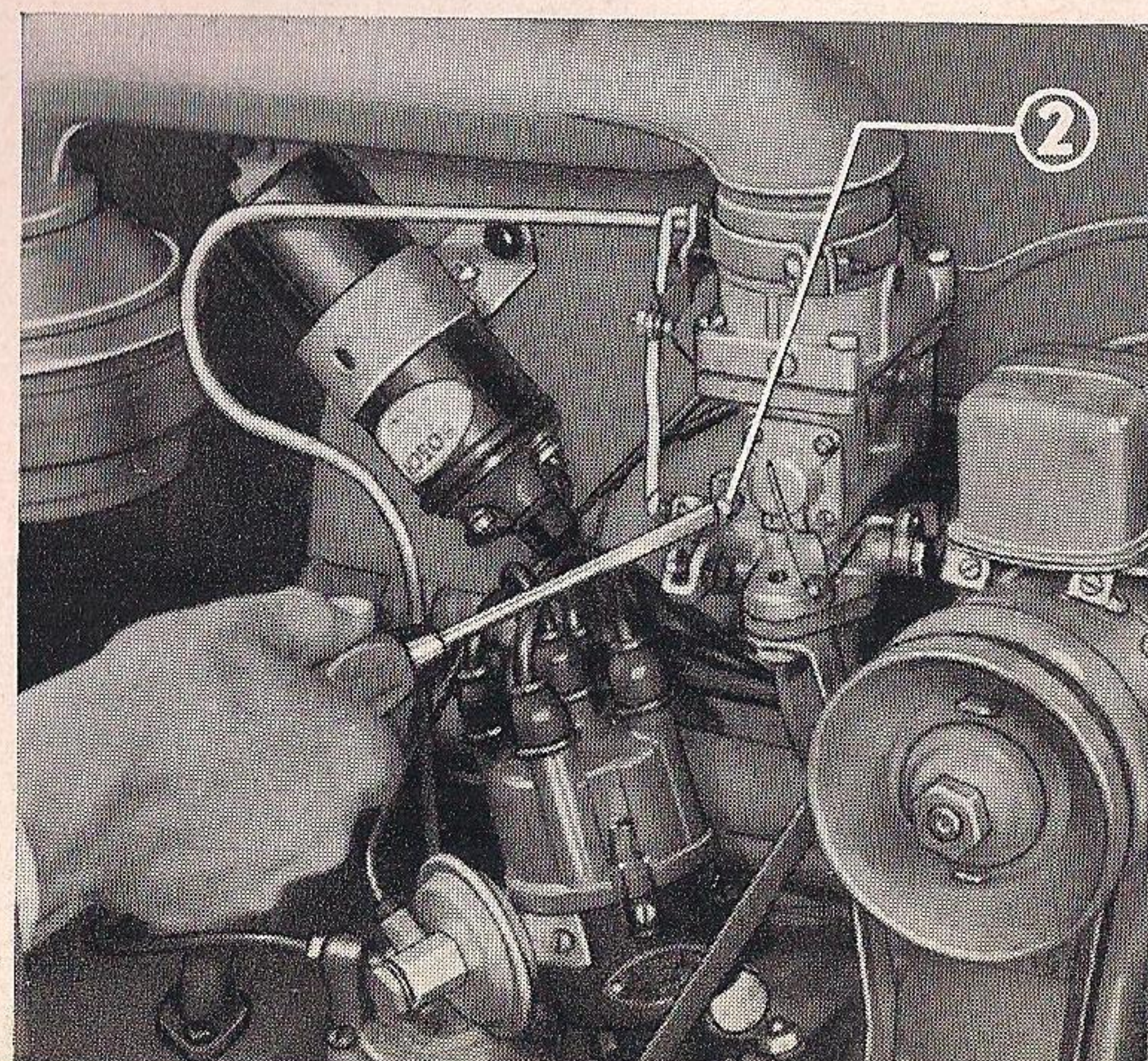
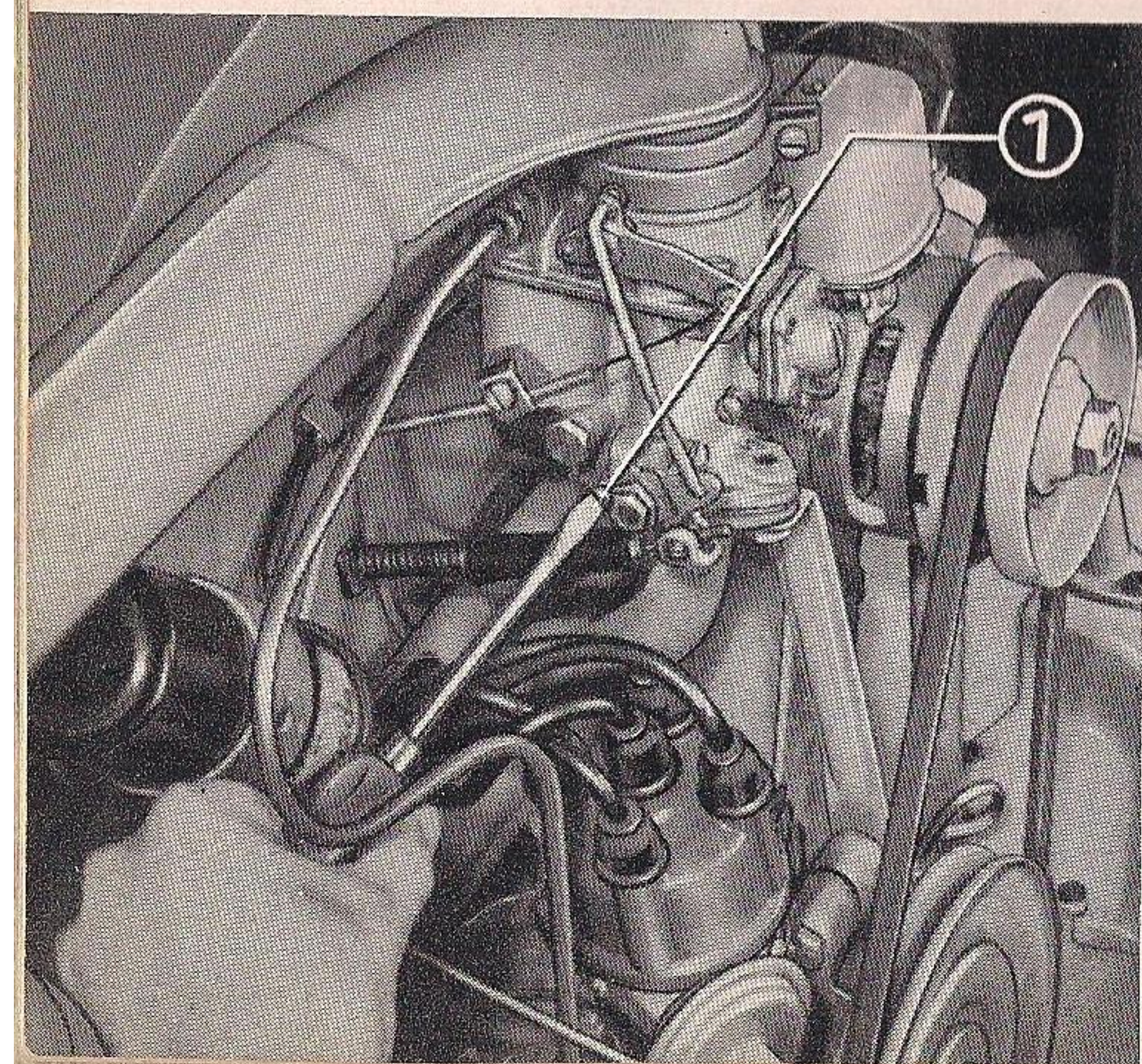

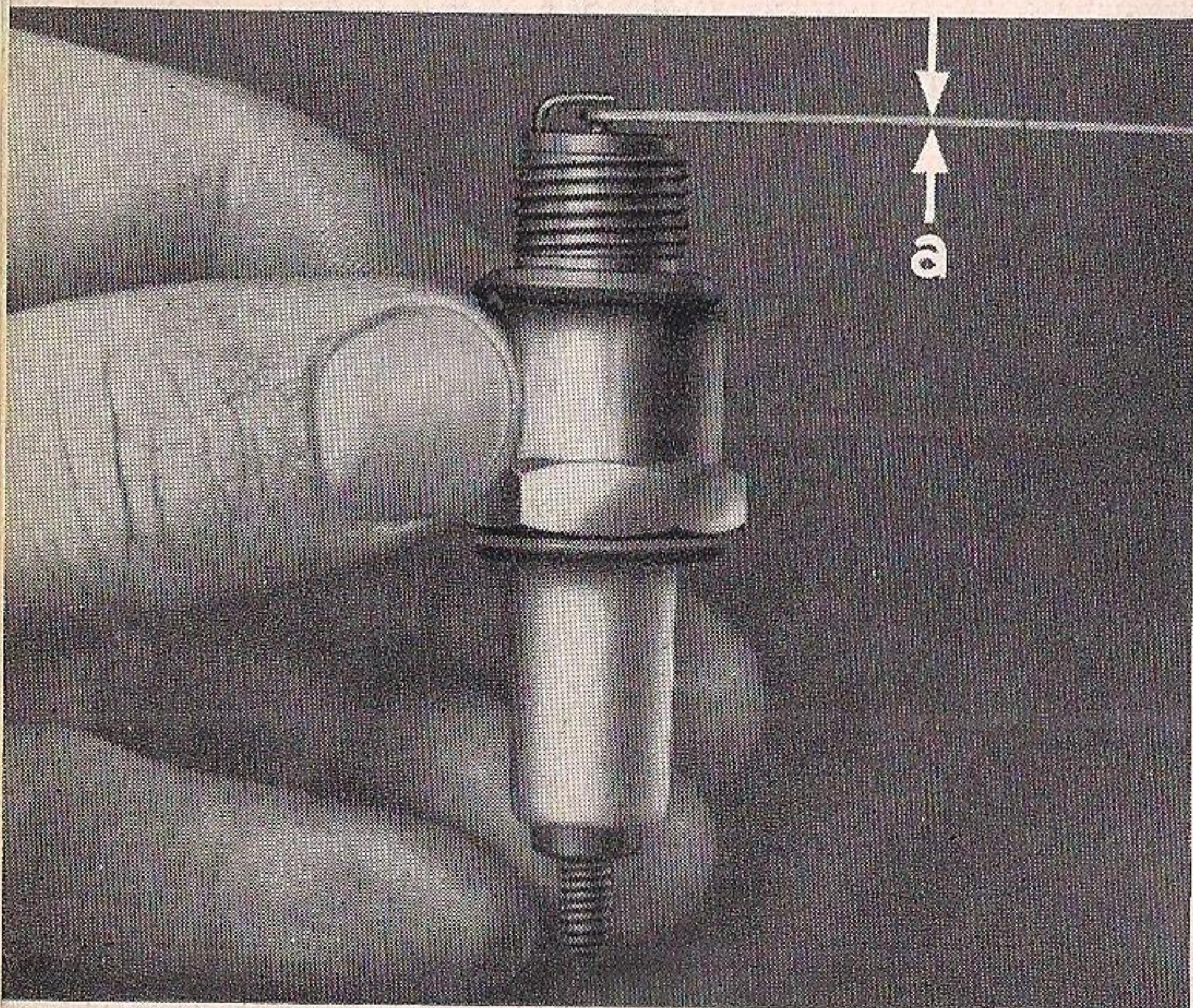
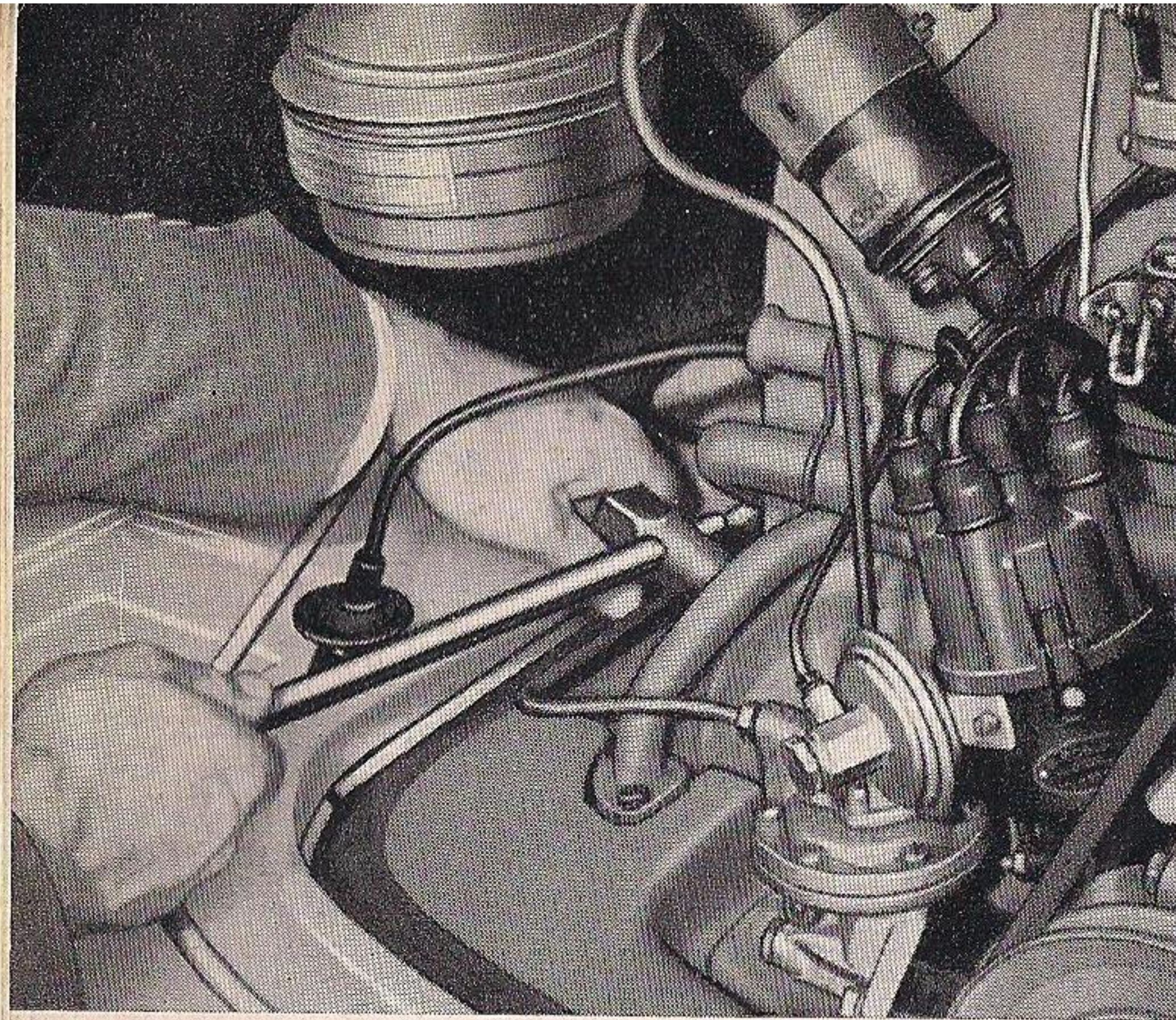

$a = 0.6-0.7 \text{ mm. } (.024''-.028'')$

Check the electrode gap (0.6—0.7 mm. = .024"—.028") and reset if necessary by bending the outer electrode. Look for a proper gasket before installing the plug. Generally speaking, you may count on a service life of the spark plugs up to 15 000 km. (9300 miles).

Ignition and Timing

Particular attention should be attached to the importance of correct ignition timing. The operation of the engine will be seriously affected if the ignition breaker points are not properly timed and correctly spaced. In many cases poor performance, high fuel consumption and even severe damage to the engine can be the result of an incorrect ignition setting. Normally, the adjustment should be done by an Authorised VW Dealer when the car is brought in for regular inspection. A few practical hints are given herewith, however, because in our experience damage is apt to result if the technical facts and data are not known.

Checking the Spark Plugs

The spark plugs must be thoroughly maintained for easy starting and economical operation. Remove the plugs and inspect their exterior.

Electrodes and insulator

- medium grey — good adjustment of carburetor and correct performance of spark plug,
- black — mixture too rich,
- lightgrey — mixture too lean,
- oiled up — failure of spark plug or worn-out cylinder.

In the case of fuels containing lead-tetraethyl (anti-knock fuel), the insulator will show a grey color, provided the engine is correctly adjusted.

Clean the spark plugs with a brush and a chip of wood and blow them out. Inspect the spark plugs for cracked insulators and burned or pitted electrodes. The insulator should be clean and dry on the outside as well to avoid short circuits.

Adjusting Contact Points

Remove distributor cap and rotor. The breaker contact points are adjusted by cranking the engine until the fiber block on the contact arm rests on the highest point of the cam lobe. Then loosen the stationary point locking screw and turn the eccentric adjusting screw until the correct gap is obtained. Use a feeler gauge of the proper thickness (0.4 mm. = .016"). Tighten lock screw and recheck the gap. If the points are burned, rough or pitted, replace them. The distributor cap should be clean and dry to avoid short circuits.

After the contact points have been adjusted, it is absolutely necessary to check the ignition timing.

Ignition Timing

Crank the engine clockwise until the mark of the crankshaft pulley lines up with the vertical crankcase jointing faces and the distributor rotor arm is in the position for firing on the No. 1 cylinder (see mark on rim of distributor base). Loosen the lock screw below the distributor base and rotate the distributor body clockwise until the contact points are closed. Now switch on the ignition and rotate the distributor slowly counter-clockwise until the contact points just mark to open. This may be seen and heard, for a spark will jump from one point to the other. This setting corresponds to 7.5° before T.D.C.

To obtain a more accurate adjustment for maximum results, it is advisable to use a test lamp (6 volts) or an ignition timing light. The test lamp should be connected to the distributor primary lead terminal and to ground. The lamp will light up as long as the contact points are kept open by one of the four cam lobes of the distributor shaft. After the adjustment is completed, tighten the lock screw, replace the rotor and clamp the cap on the distributor. Check vacuum tube union nuts for tightness.

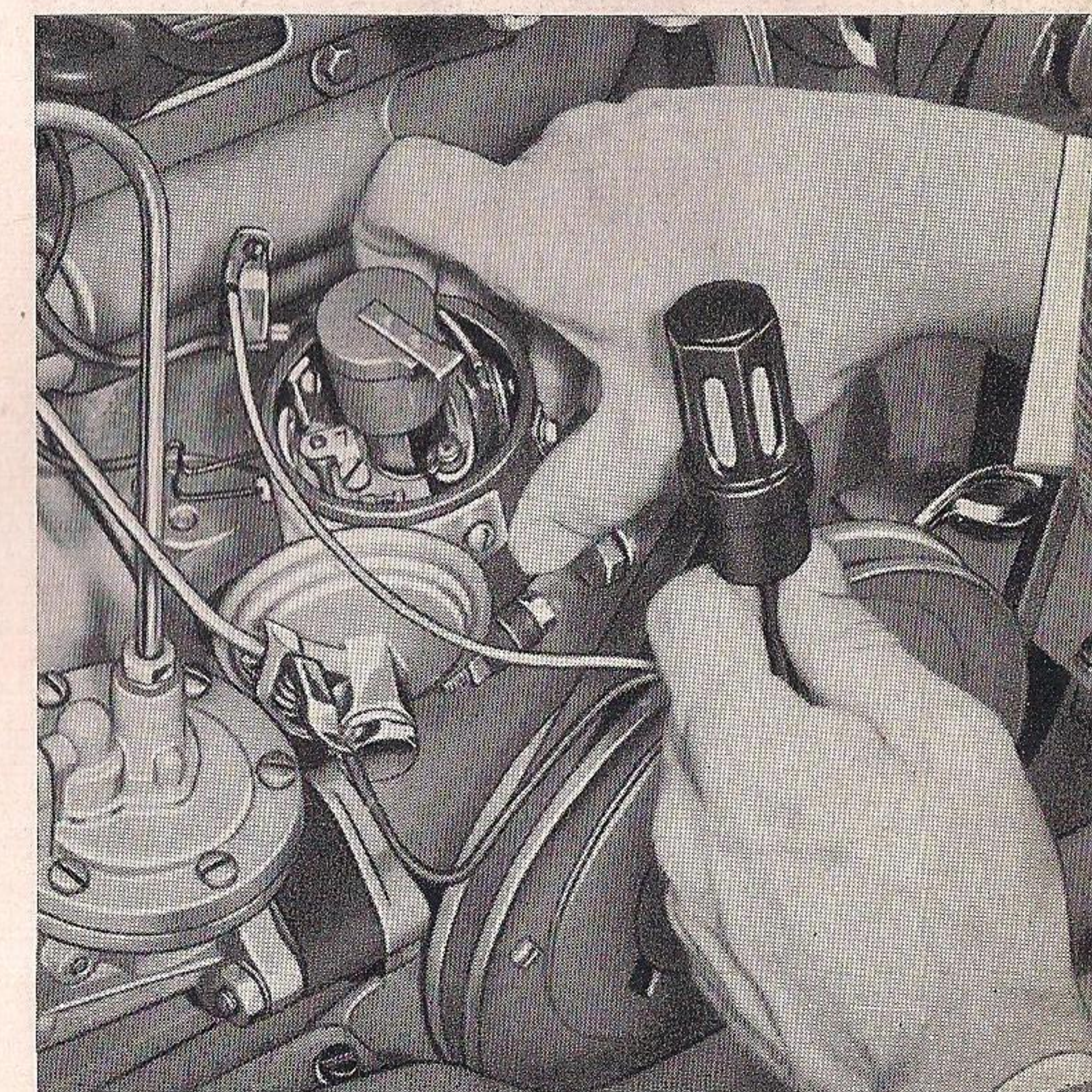
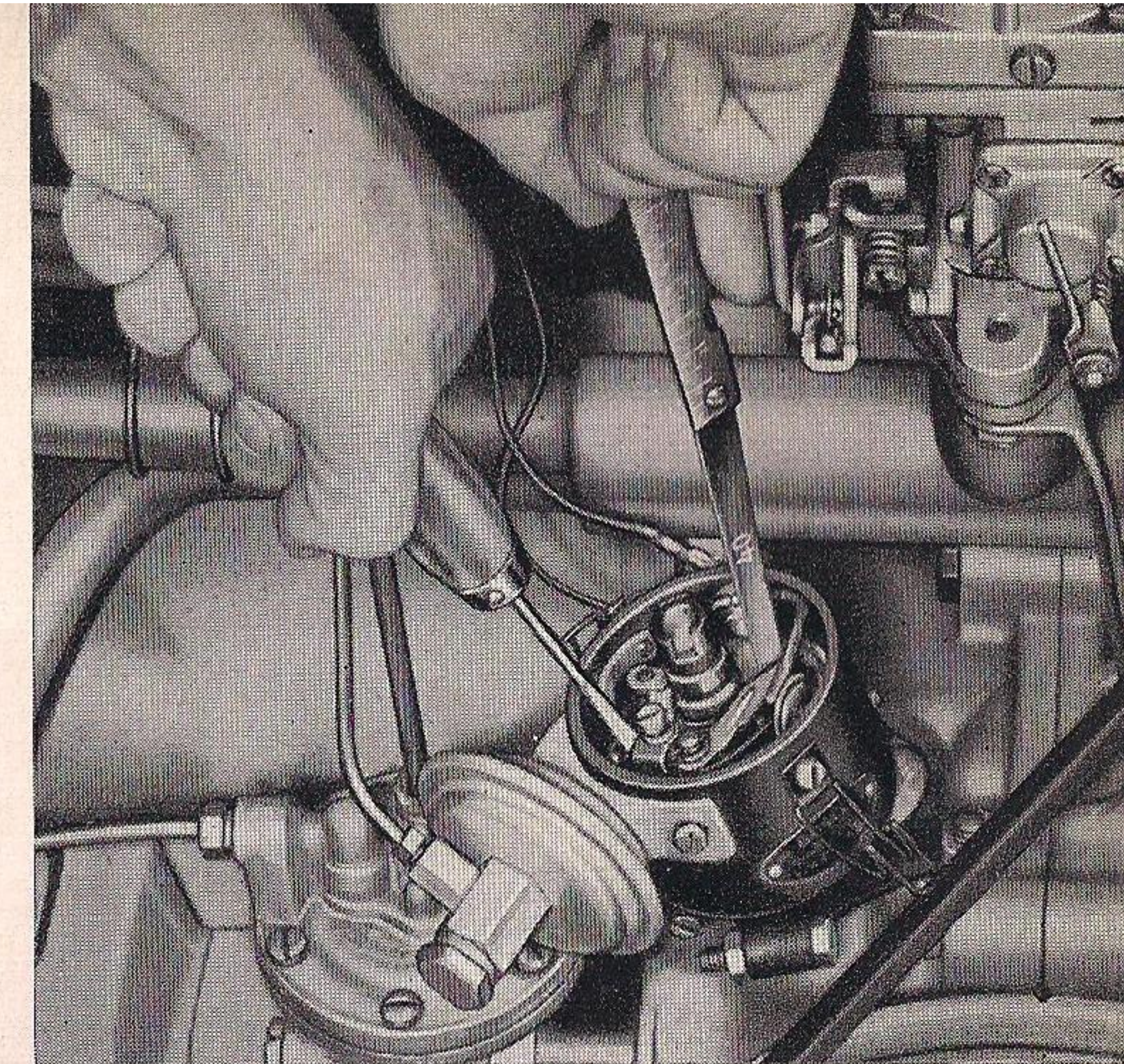

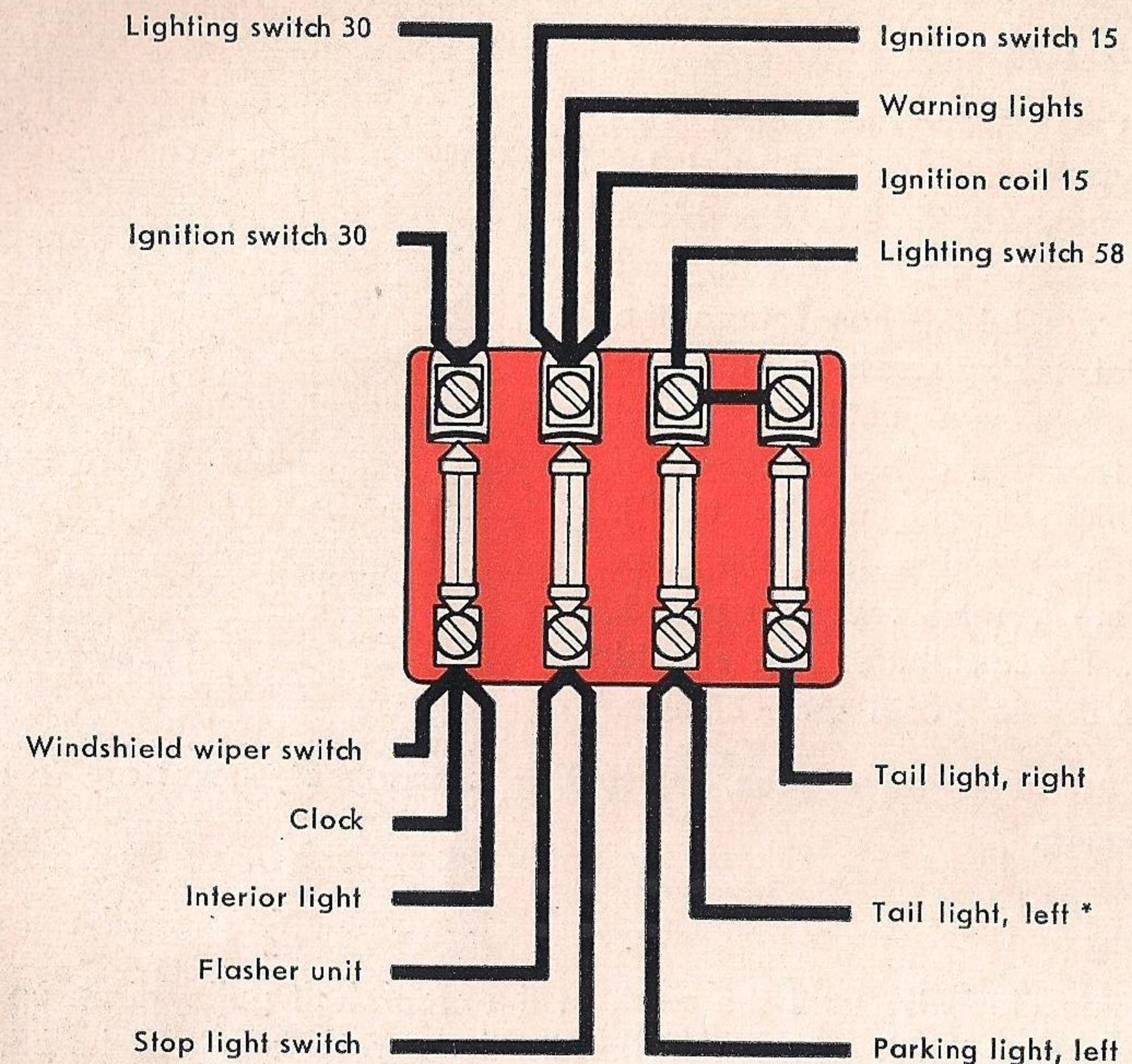

* Not applicable to Sealed Beam

Fuse box on the back of the instrument panel

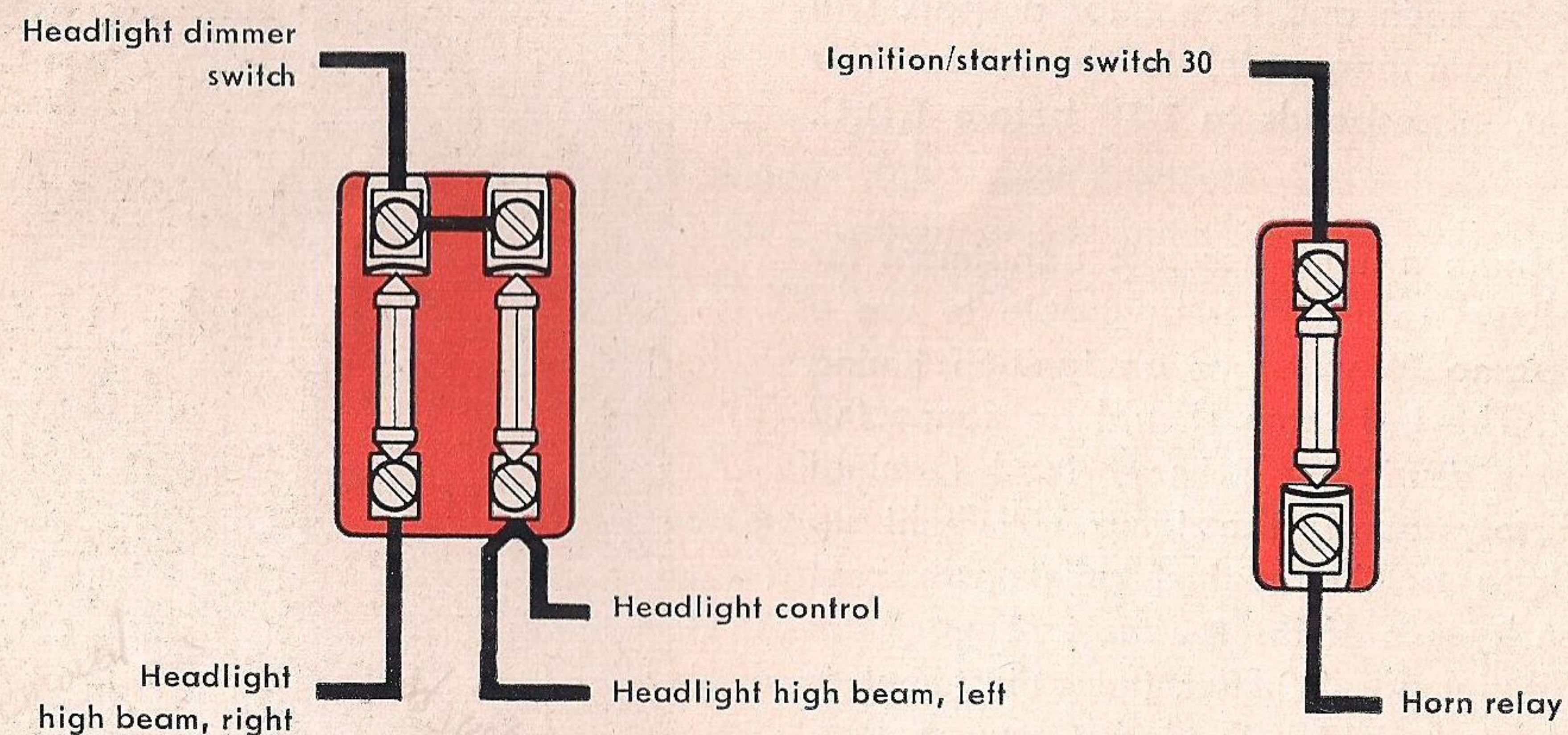

Fuse box adjacent to the fuel tank

Connector and fuse on the back of the instrument panel

Exchanging Fuses

The two fuse boxes are found:

a - underneath the front hood, to the left of the fuel tank,

b - underneath the front hood, on the back of the instrument panel.

A connector provided with a fuse is in the cable between ignition switch and horn relay.

When a fuse has blown out, it is not sufficient to merely replace it by a new one. Inspect the electrical system for evidence of short circuits or other faults that may have caused the fuse to blow out.

Under no circumstances should you use a fuse patched up with tin-foil or wire, because this may result in severe damage. We suggest that you carry with you a set of spare fuses (8/15 amp.).

Not applicable to „Sealed Beams“

Headlight Bulb Replacement

Remove the slotted screw at the bottom of the front rim and unhook the rim from the top engagement for removal. Loosen the fixing screw at the bottom of the light unit rim and pull out the light unit. Unhook the tension spring, and pull out the lamp holder. When replacing the bulb, make sure the new bulb is clean and that it is not loose in the socket. When a broken lens is being replaced, the reflector should not be touched or wiped off.

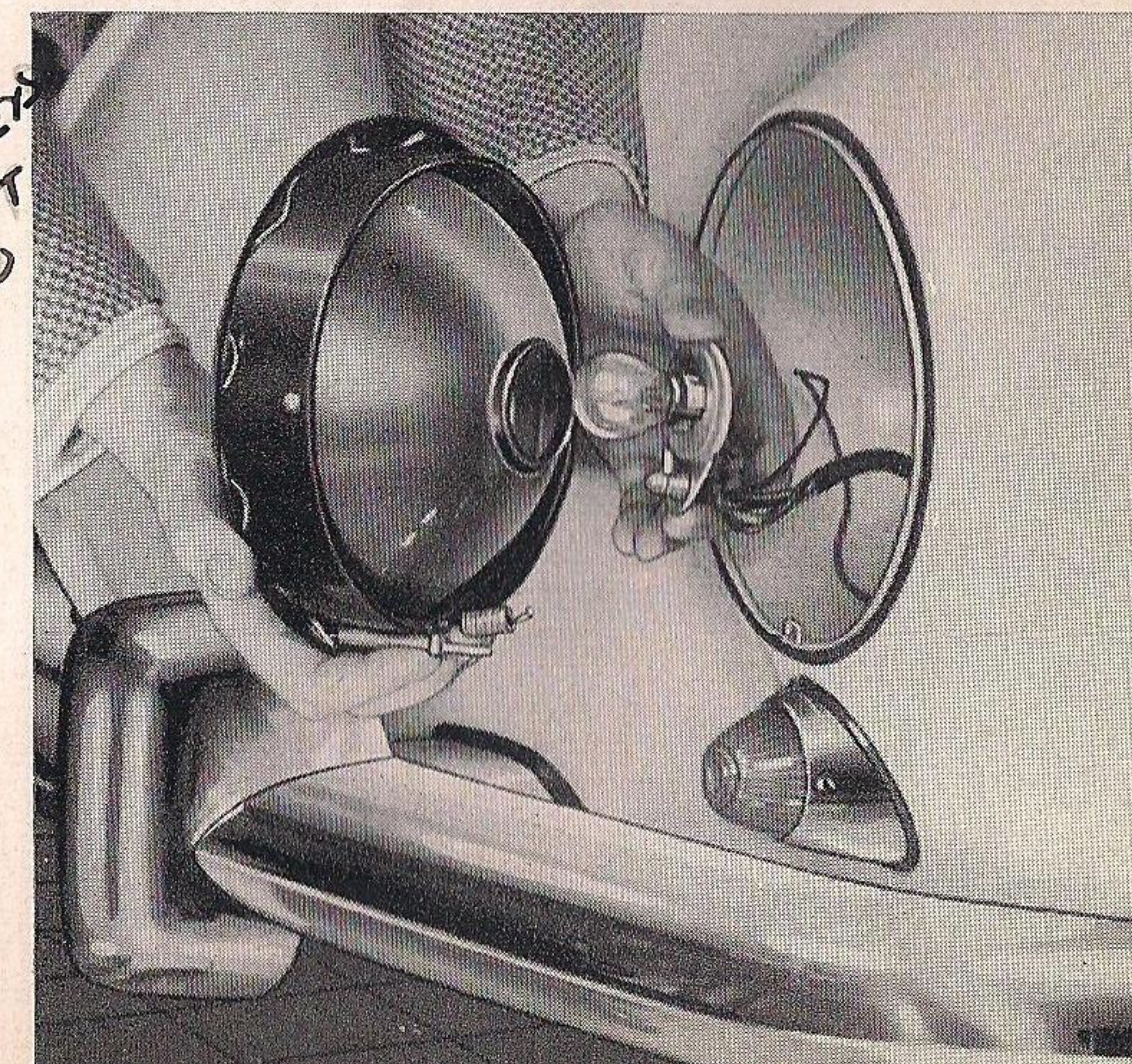
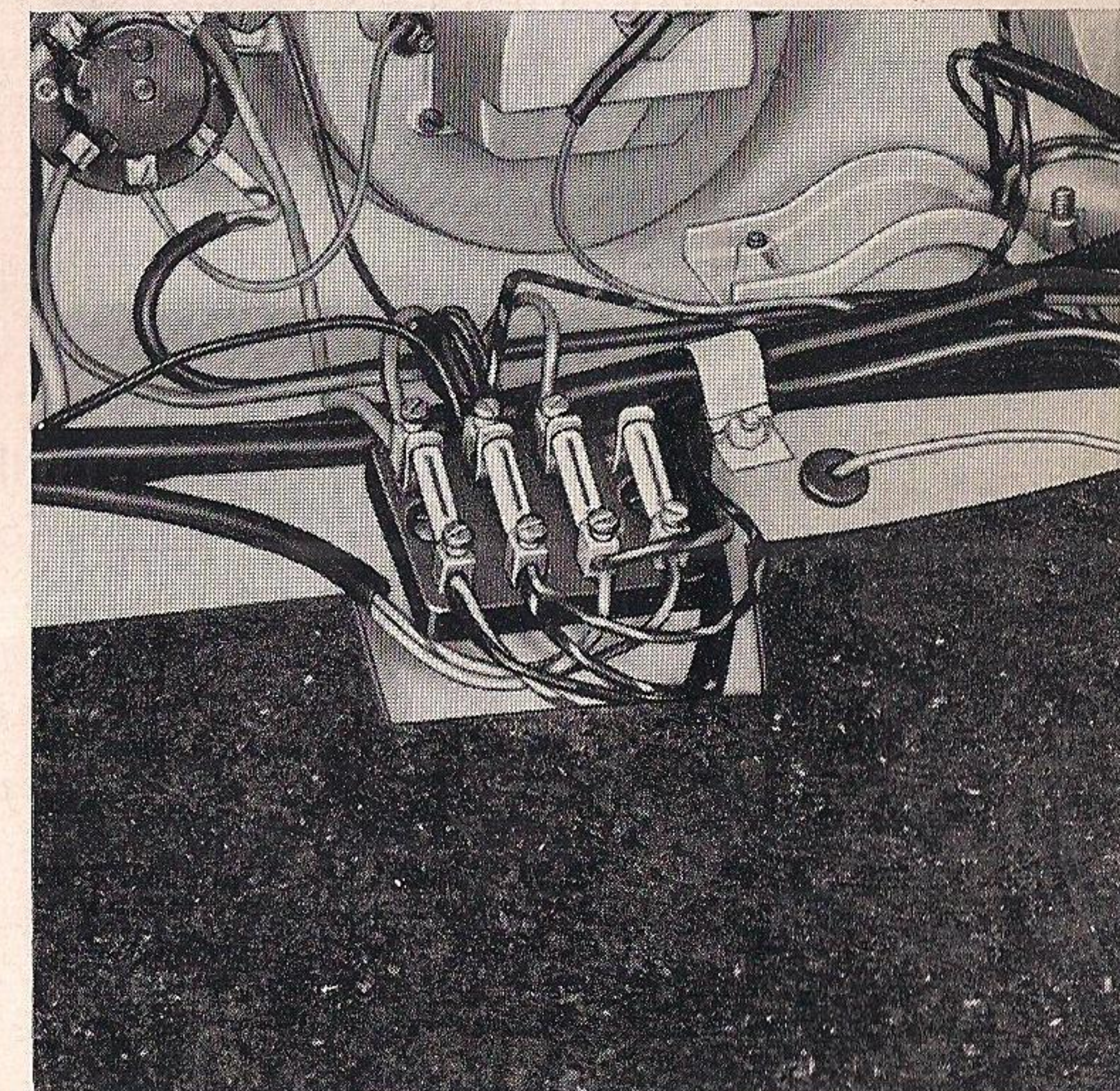
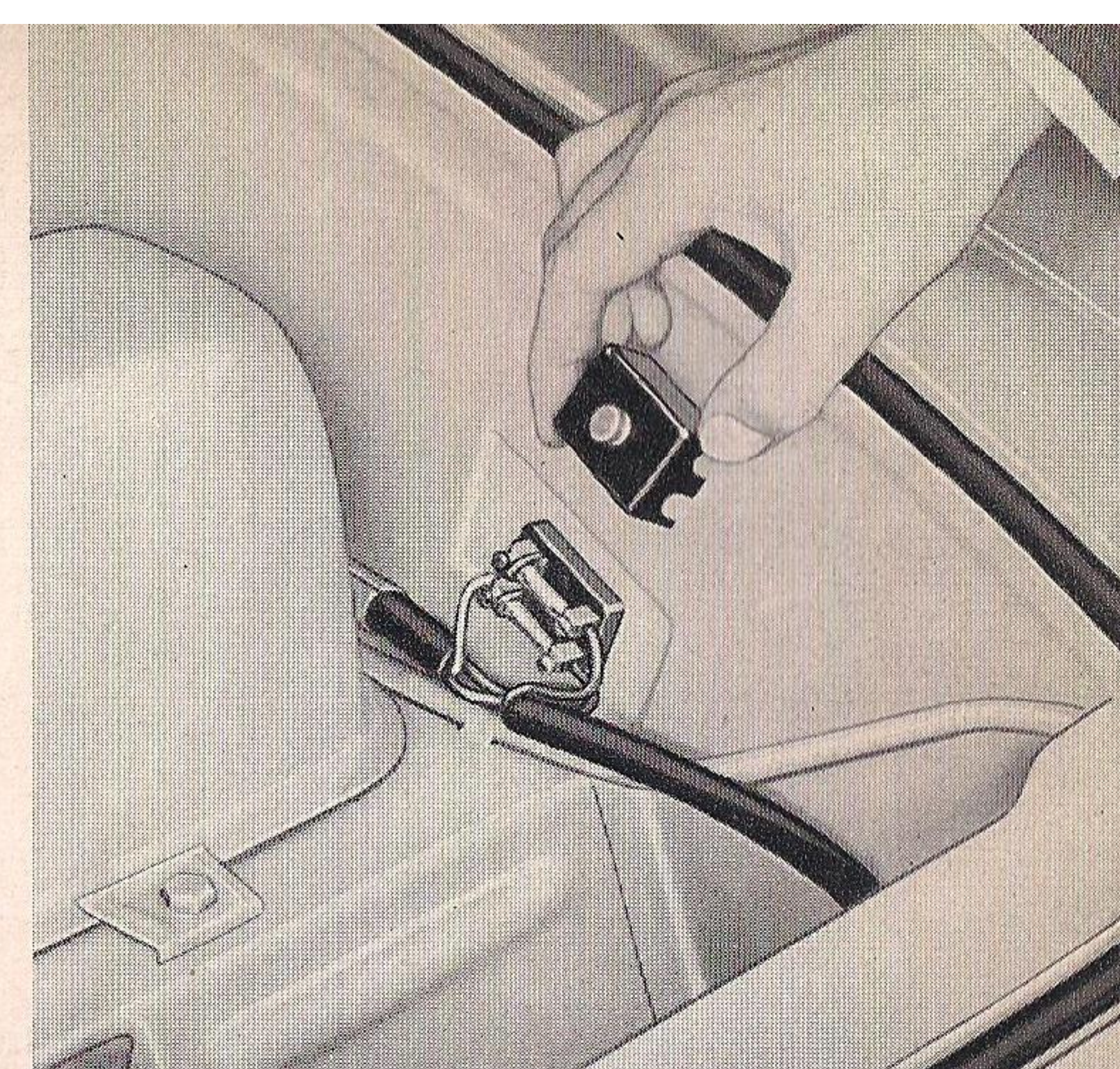

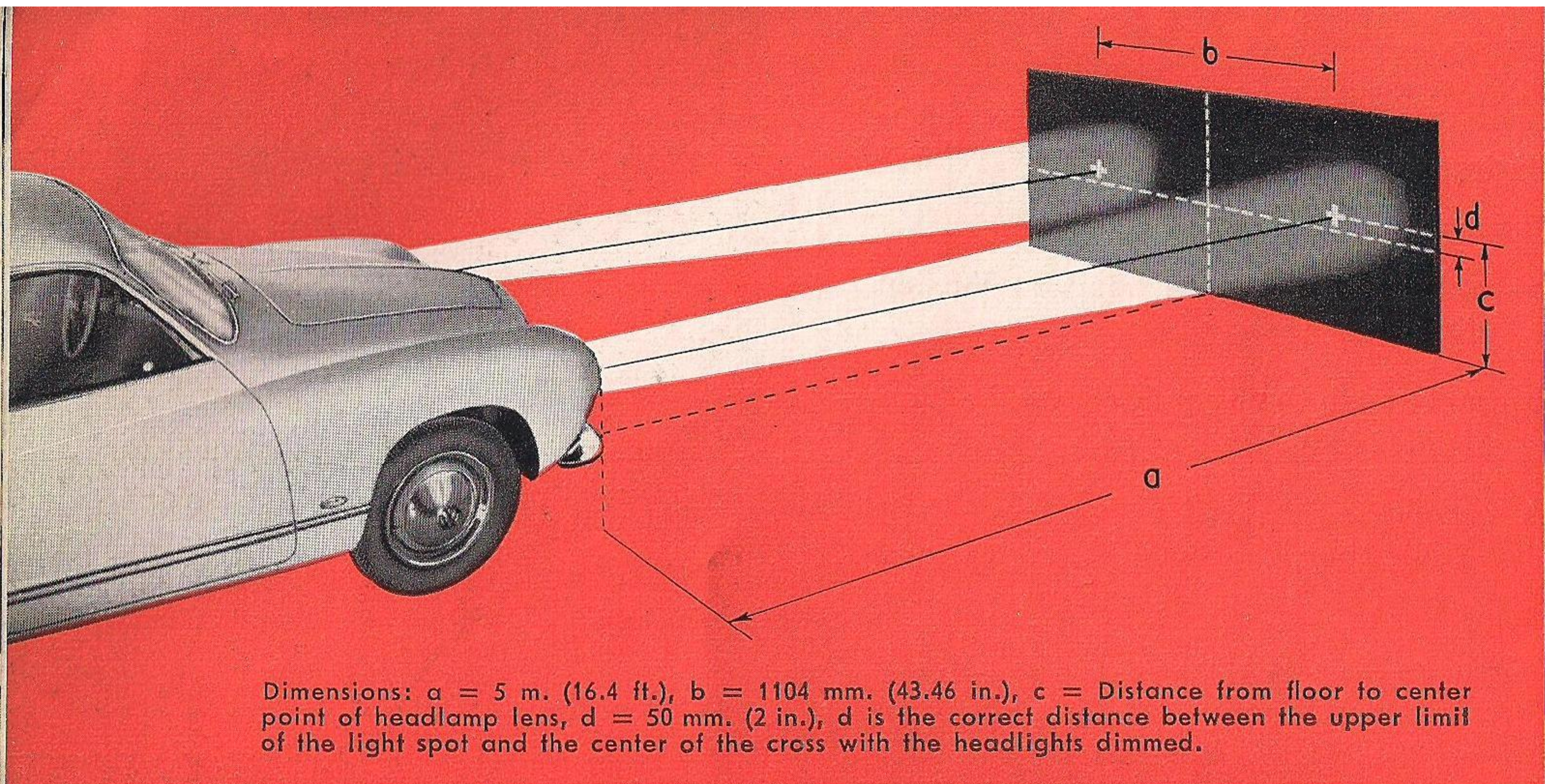

Dimensions: a = 5 m. (16.4 ft.), b = 1104 mm. (43.46 in.), c = Distance from floor to center point of headlamp lens, d = 50 mm. (2 in.), d is the correct distance between the upper limit of the light spot and the center of the cross with the headlights dimmed.

Aiming the Headlights

If no headlight aiming device is available, proceed as follows:

- 1 - Place the unloaded car on a level position with a dark-colored vertical screen 5 m. (16.4 ft.) ahead.
- 2 - Next draw two cross lines on the screen according to the sketch.
- 3 - The longitudinal center line (car axis) must hit the center of the screen exactly between the two cross marks.
- 4 - Switch on the high (country) beams and check the beams at the cross marks.
- 5 - Remove the slotted screw at the bottom of the front rim and unhook the rim from the top engagement for removal.
- 6 - Independent adjustment of both horizontal and vertical aim is provided with the adjustment screws in the headlight unit rim.

Vertical Adjustment

Turn lower screw

- to right — Beam swings up
- to left — Beam swings down

Horizontal Adjustment

Turn right screw

- to right — Beam swings to left
 - to left — Beam swings to right
- ("Right" and "Left" is as indicated when sitting in the car facing forward.)

Then switch on the low beam and check the distance between the upper limit of the light spot and the center of the cross (2").

Front Direction Indicator Bulb Replacement

Pull rubber boot from bulb holder and loosen the hex. nut. Remove the two slotted screws and take off bezel, lens, and rubber seal. Replace the bulb. When tightening the nut, make sure the bezel properly seats in the channel provided in the rubber seal.

License Plate Light Bulb Replacement

The license plate light bulbs are accessible through openings from under the engine compartment hood.

Tail Light and Stop / Direction Indicator Light Bulb Replacement

To replace the bulbs of the two combined tail/stop/indicator lights in the rear wings, remove the slotted screws and take off the lenses. Be sure the bulbs make perfect contact in their sockets.

Warning and Instrument Light Bulb Replacement

The warning lights for oil pressure, generator charging, direction indicator, and headlight main beam, as well as the speedometer lights, are accessible by lifting the front hood and removing the cover in front of the instrument panel. The bulb sockets can easily be pulled out from their holders.

- 1 - Clock lighting bulb
- 2 - Clock lighting bulb
- 3 - Speedometer lighting bulb
- 4 - Direction indicator lamp
- 5 - Speedometer lighting bulb
- 6 - Oil pressure warning lamp
- 7 - Headlight warning lamp
- 8 - Generator warning lamp

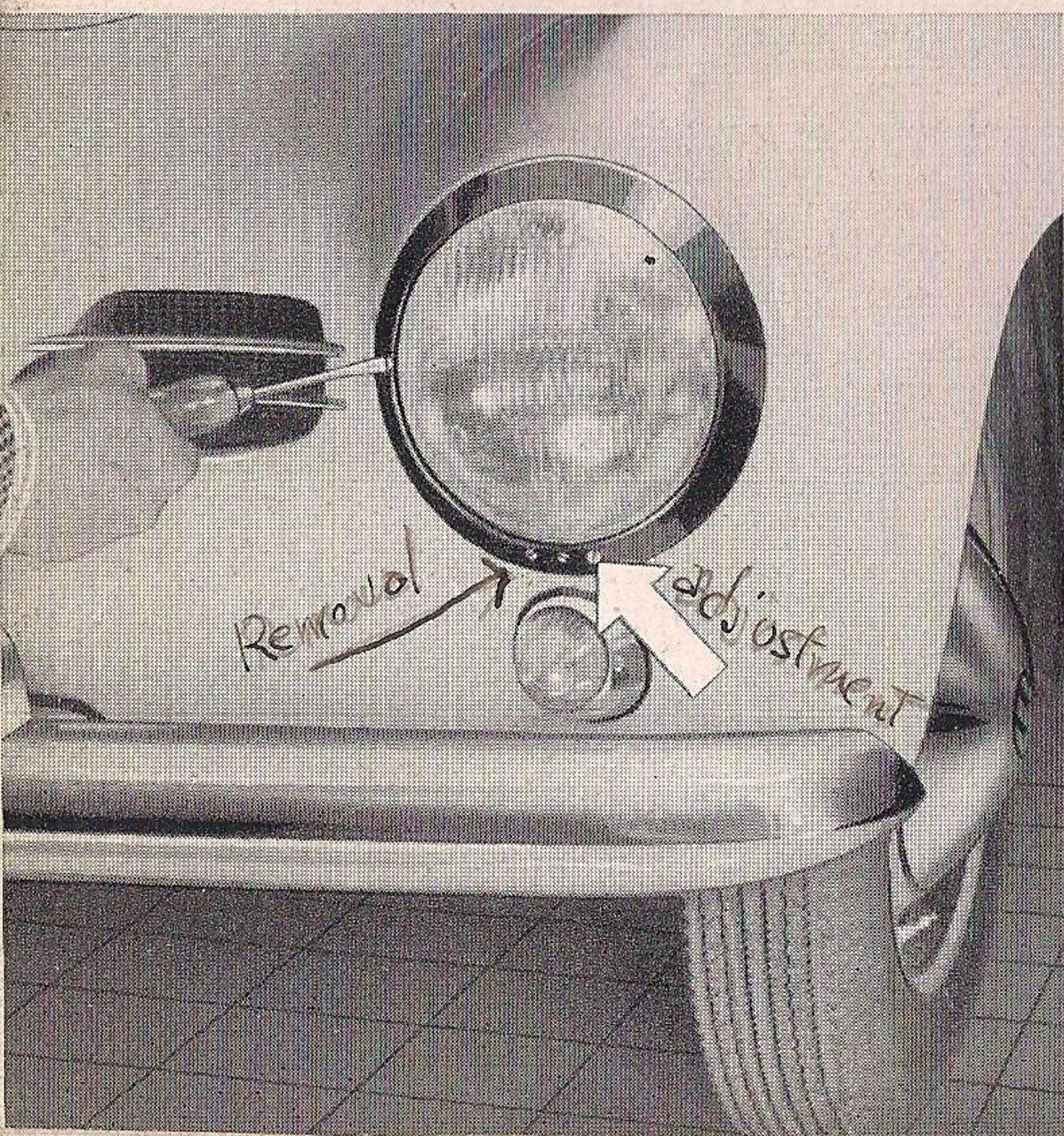
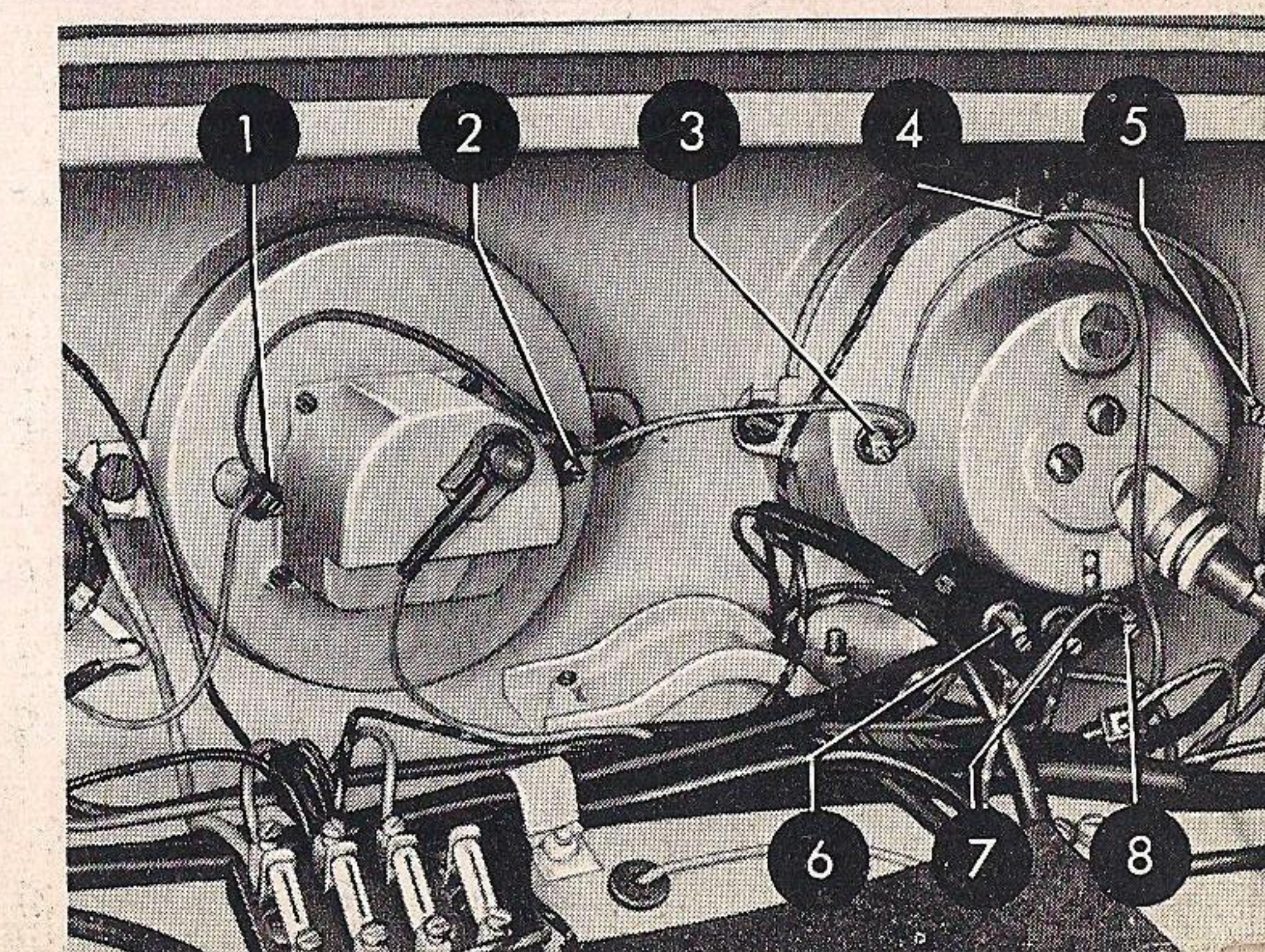
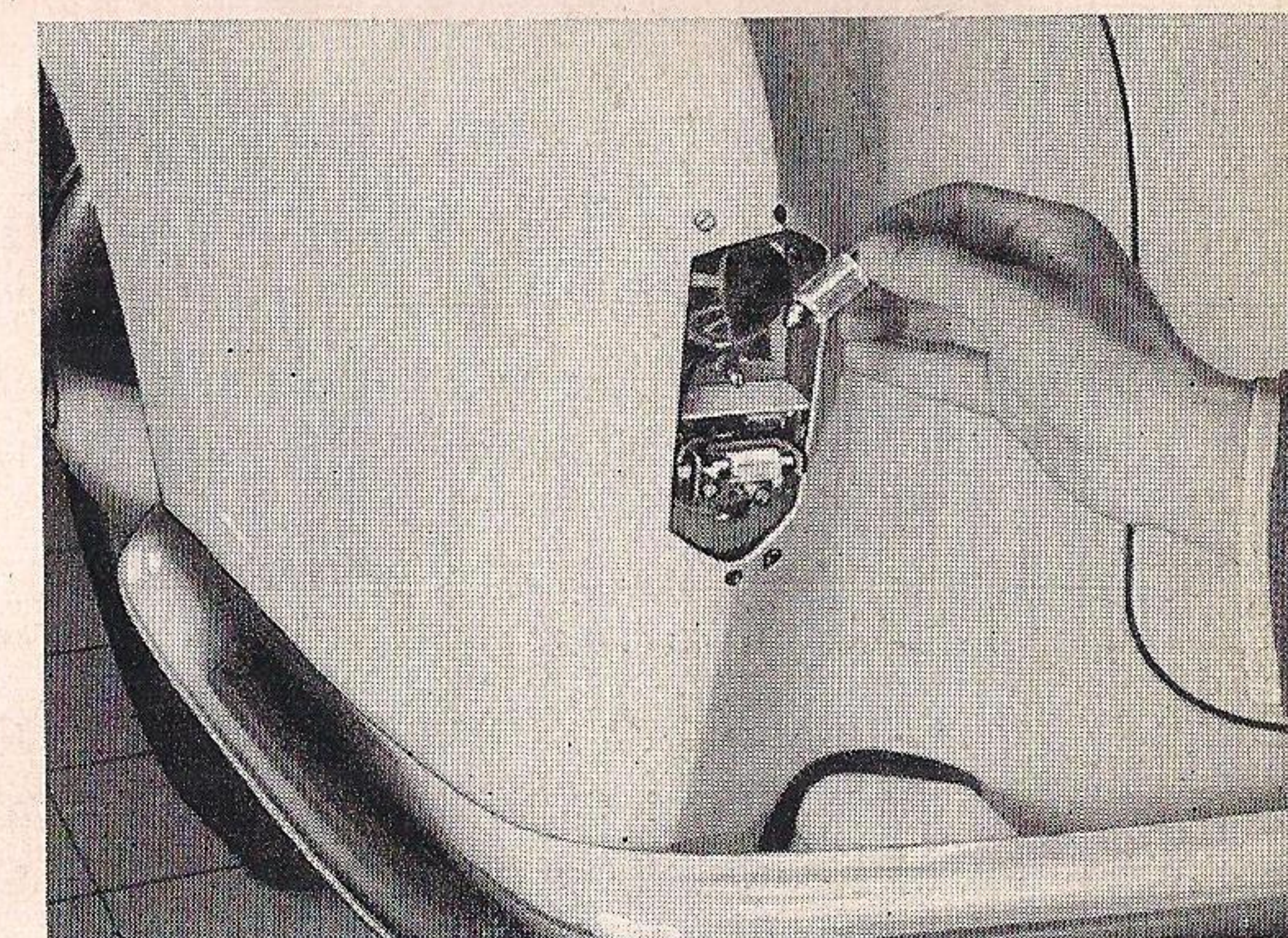
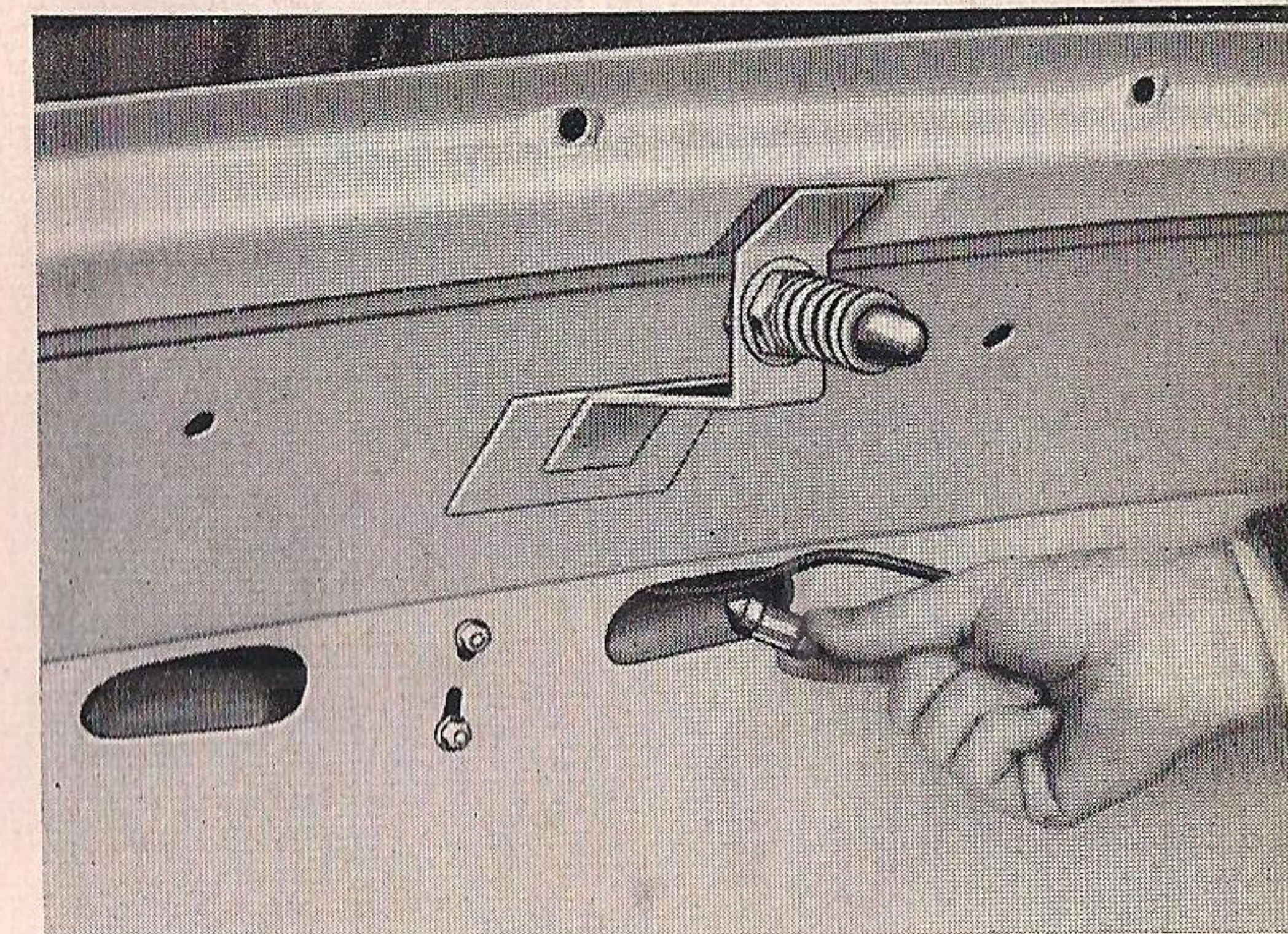
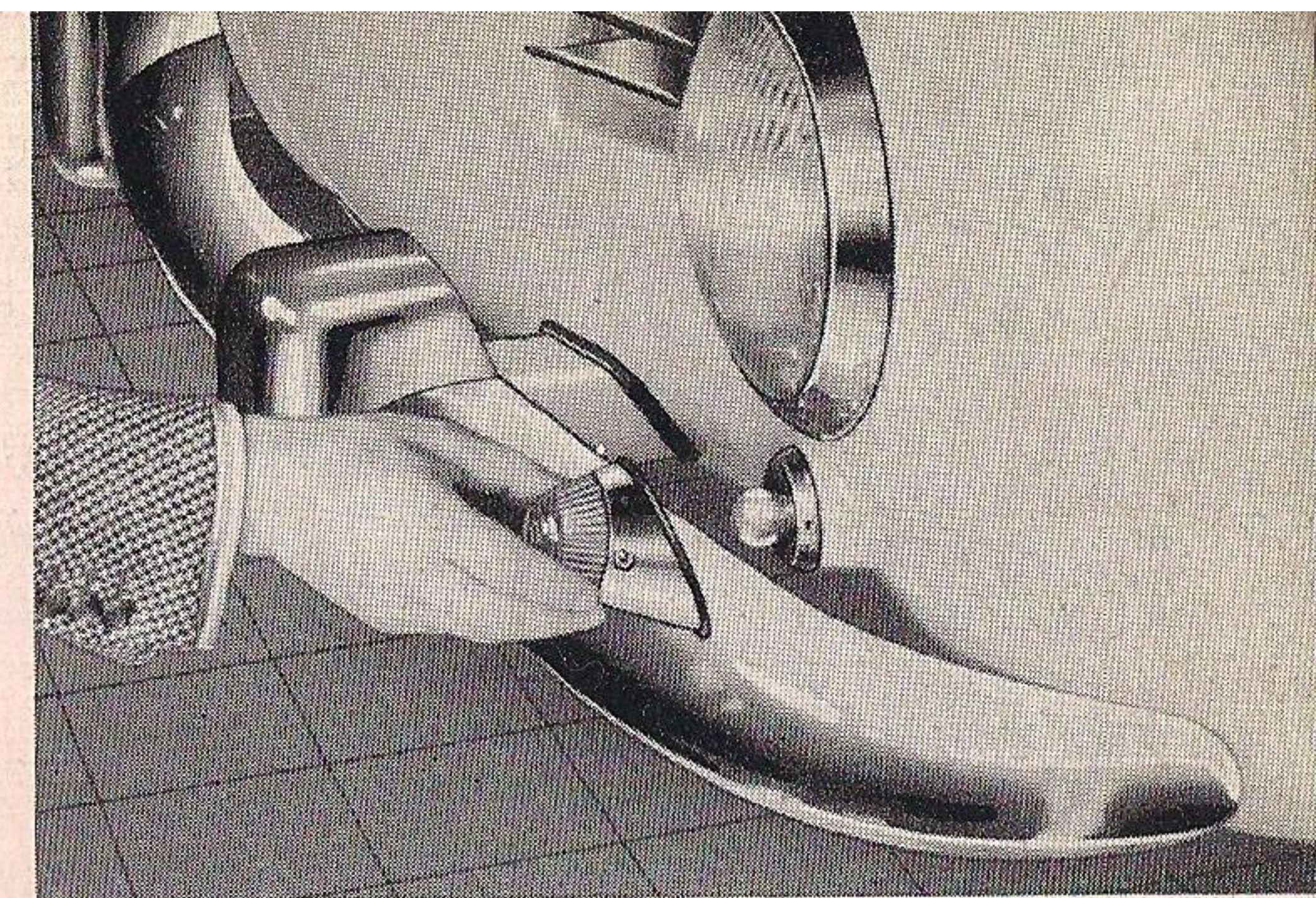

Battery Maintenance

The battery is located in the engine compartment, where it is easily accessible for servicing. Ready starting of the engine depends upon perfect condition of the battery. Inspect the battery regularly as prescribed in the Maintenance Chart and even more frequently under conditions of extreme heat.

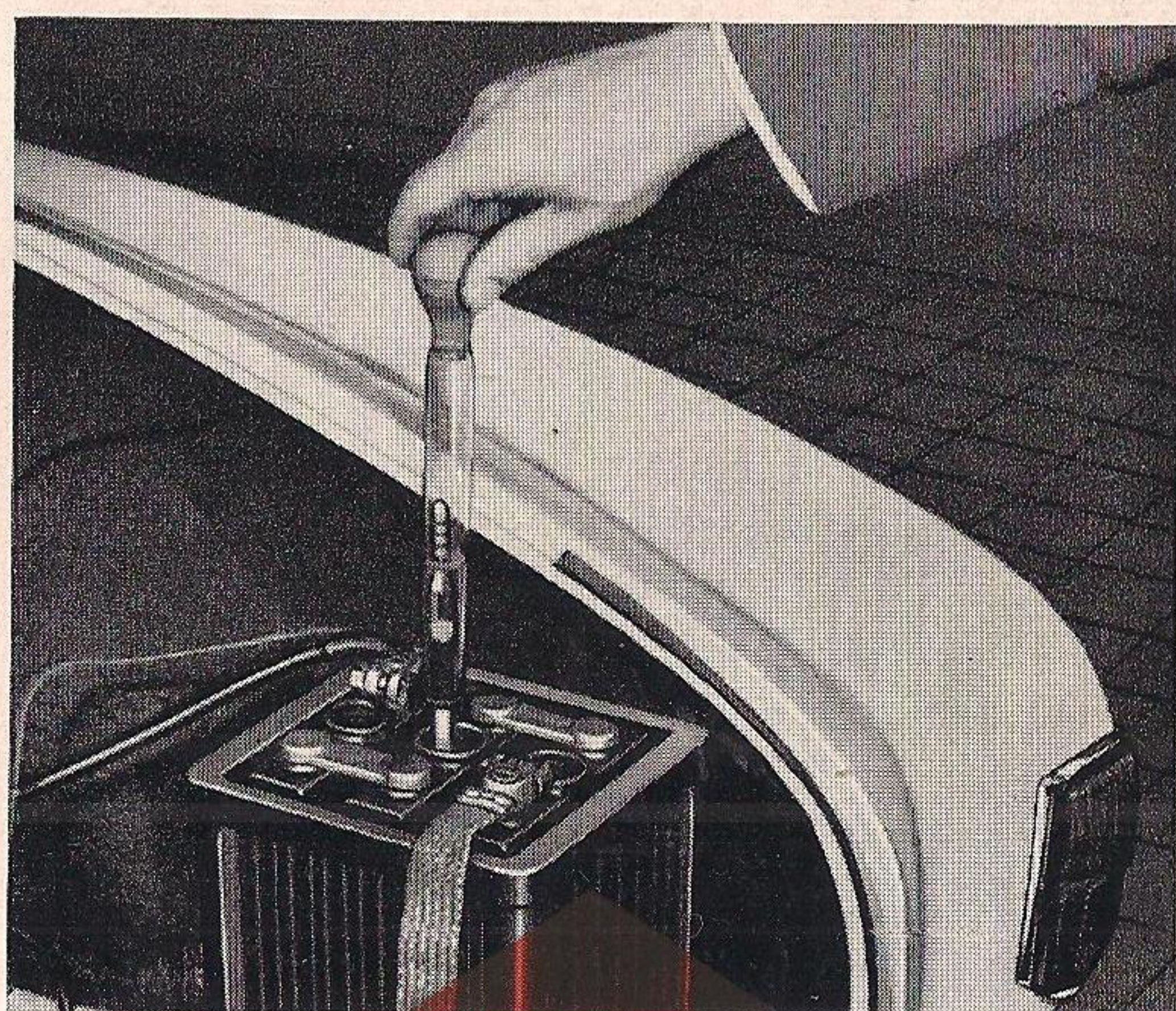
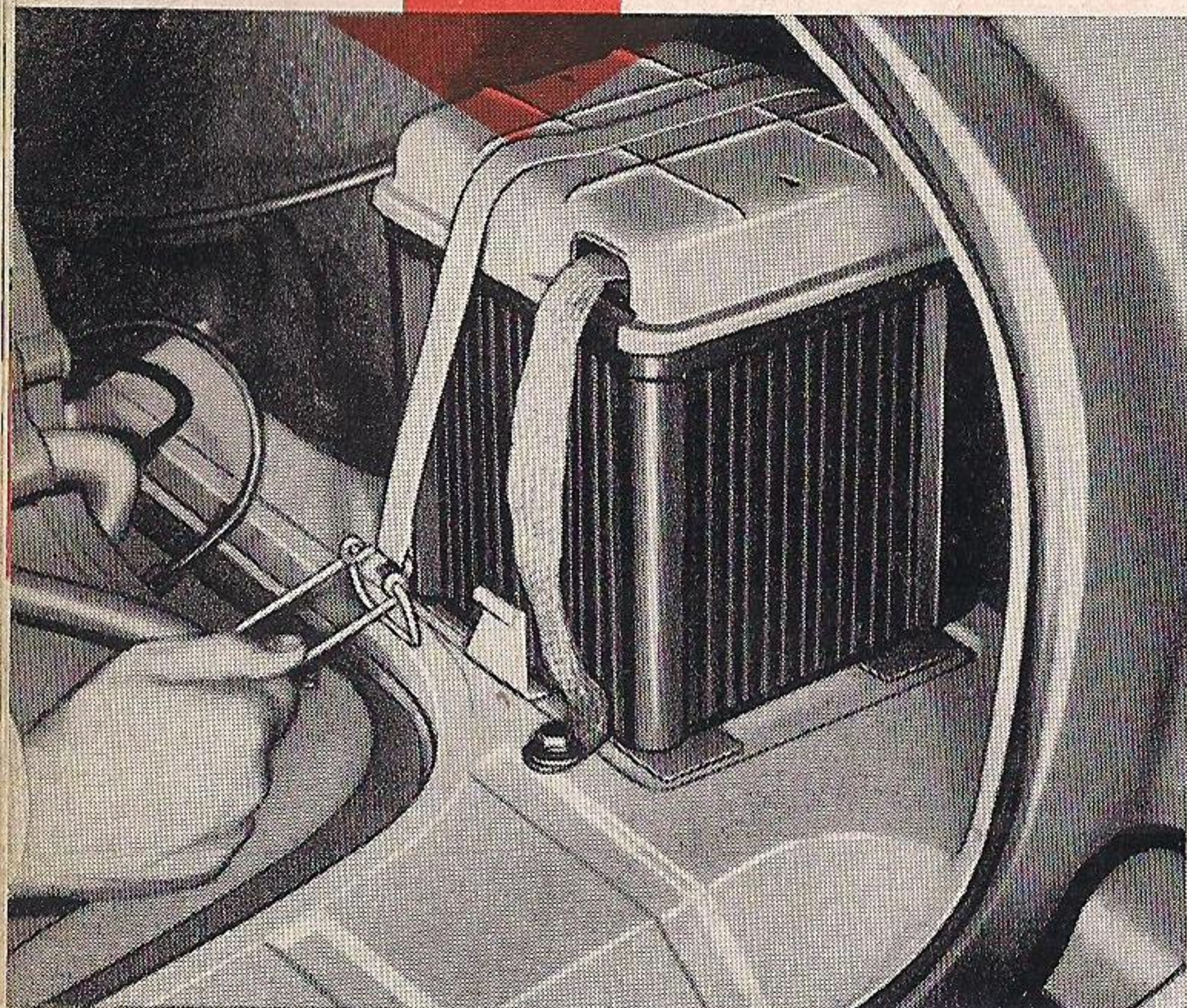

Hydrometer Test

The state of charge of the battery may be checked by means of a battery hydrometer. The specific gravity of the battery liquid will increase with the charging of the battery. Tested with the hydrometer, the gravity can be read from the scale of a float.

Battery fully charged	1.285 = 32° Bé
Battery semi-charged	1.230 = 27° Bé
Battery fully discharged	1.142 = 18° Bé

Voltage Test

In addition, a voltmeter test should be made to insure that the battery is in good operating condition and able to provide the necessary current. The voltage of each cell should not fall below 1.6 volts while taking the reading (10—15 seconds). Otherwise the cell is discharged or defective. Under no-load conditions each charged cell should read 2.0 volts.

Electrolyte Level

Add distilled water to each cell to bring the level to approximately 5 mm. (.2") above the plates or above the deflector plate, if present. Losses by evaporation may only be replenished by adding distilled water. Never add acid, unless it is known that acid has been spilled from the battery. Check specific gravity afterwards and compensate if necessary. Check condition of the battery posts and the

terminal terminals. They must be clean and tight to prevent excessive electrical resistance. Use a stiff brush to remove corrosion from both posts and terminals. Coat the clean posts and terminals with light grease or vaseline to prevent corrosion. Make sure that the battery is properly grounded.

Brake Adjustment

Brake adjustment should be performed by an Authorized VW Dealer. However, if an emergency arises where the brakes must be adjusted before you can reach the next repair shop, the following procedure for bleeding and adjusting can be used.

The fluid reservoir is located under the front hood behind the spare wheel. To fill up, use only Genuine VW Brake Fluid or Lockheed Brake Fluid. The fluid reservoir should be kept at least $\frac{3}{4}$ full at all times.

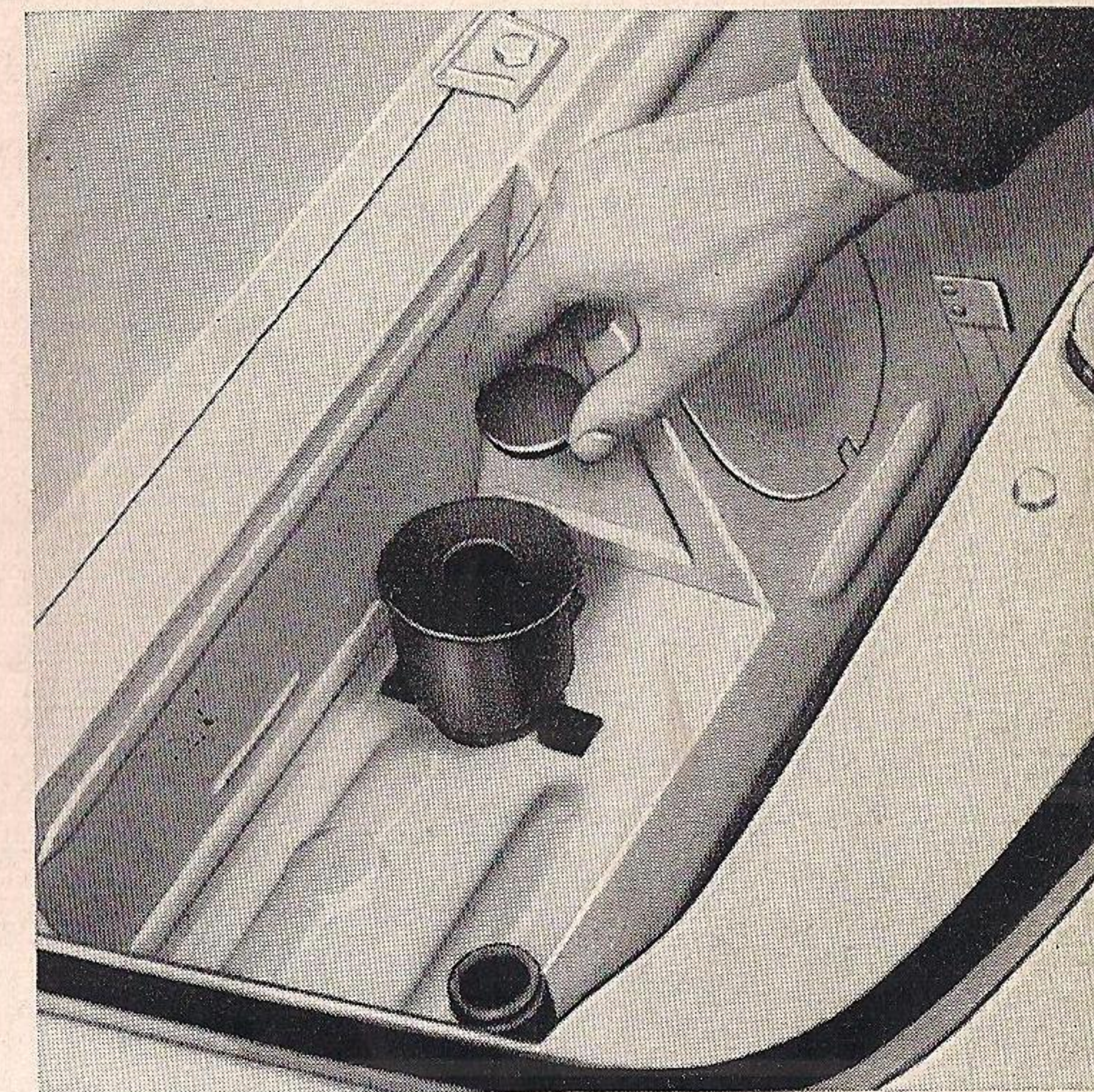

Bleeding Hydraulic System

The hydraulic brake system must be bled whenever a fluid line has been disconnected or air has got into the system. The presence of air will cause "spongy" brake pedal operation.

- 1 - Remove rubber cap of the bleeder valve of one wheel cylinder and attach one end of the brake bleeder hose to the valve.
- 2 - Place the opposite end of the bleeder hose in a glass container partly filled with brake fluid so that the end of the hose is submerged.
- 3 - Turn the bleeder valve to the open position (1—2 turns).

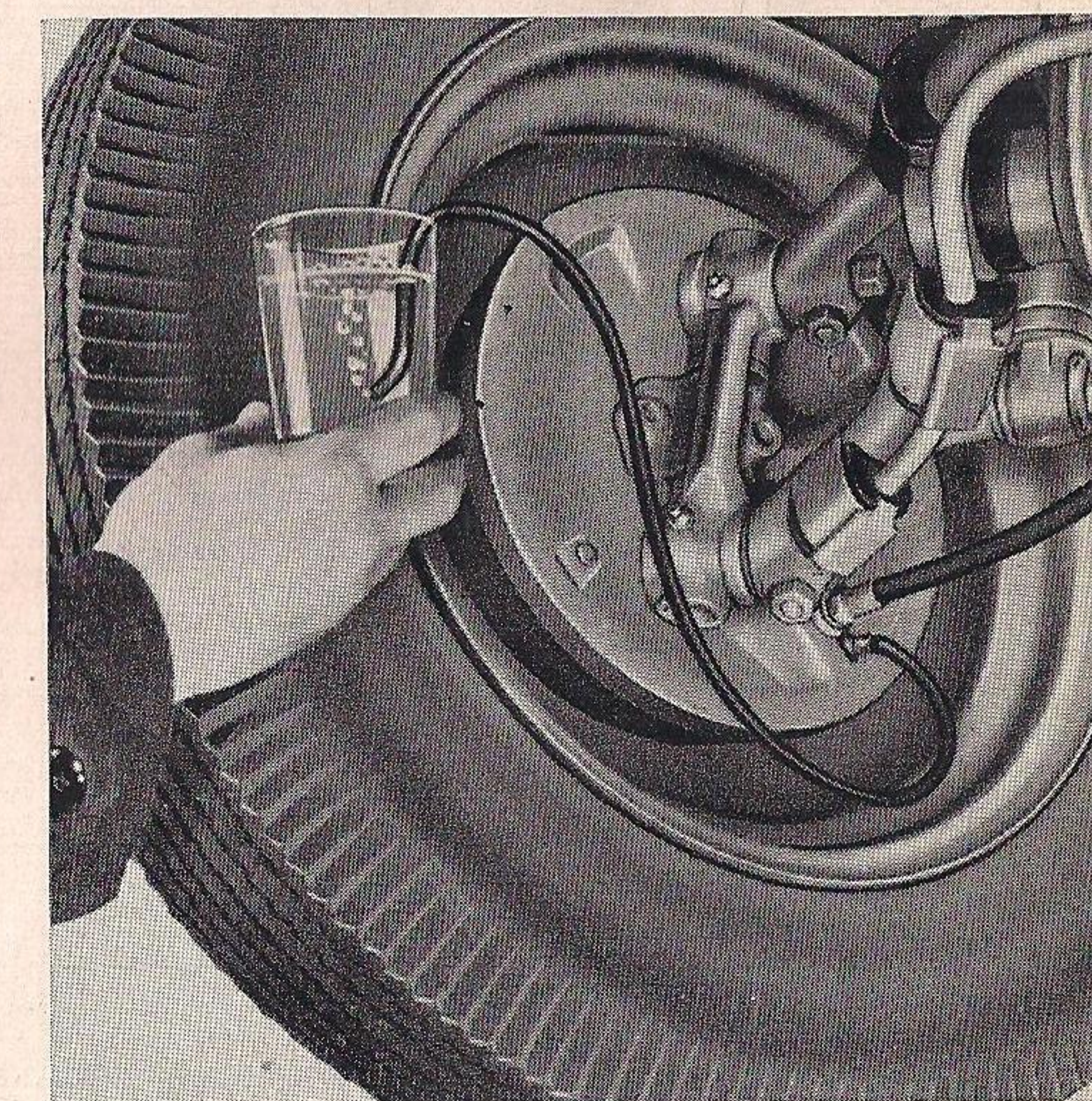

4 - Pump the brake pedal several times, forcing fluid through the lines. When bubbles cease to appear in the container, close the bleeder valve (the brake pedal should be kept in the fully depressed condition until the bleeder valve is closed) and remove the hose. Replace rubber cap. Make sure that enough brake fluid remains in the fluid reservoir during the bleeding operation, since otherwise air will be sucked in.

5 - Repeat the above operations on the other wheels.

6 - When the bleeding is completed, refill the master cylinder reservoir with brake fluid.

Adjusting Hydraulic Brake

Brakes require periodic adjustment to assure their proper operation. Too much free travel of the brake pedal is an indication that the clearance between brake shoes and brake drums has become too great and that the brakes need adjustment. This adjustment will usually compensate for such wear that will take place until relining of the shoes is required.

1 - Jack up all wheels clear off the floor. Turn forward the wheel to be adjusted, until the hole in the brake drum is in line with one of the adjusting nuts.

2 - Insert a screwdriver through the hole and turn the adjusting nut in the direction indicated by the arrow, using screwdriver as a lever, until a slight drag is noted when wheel is turned by hand.

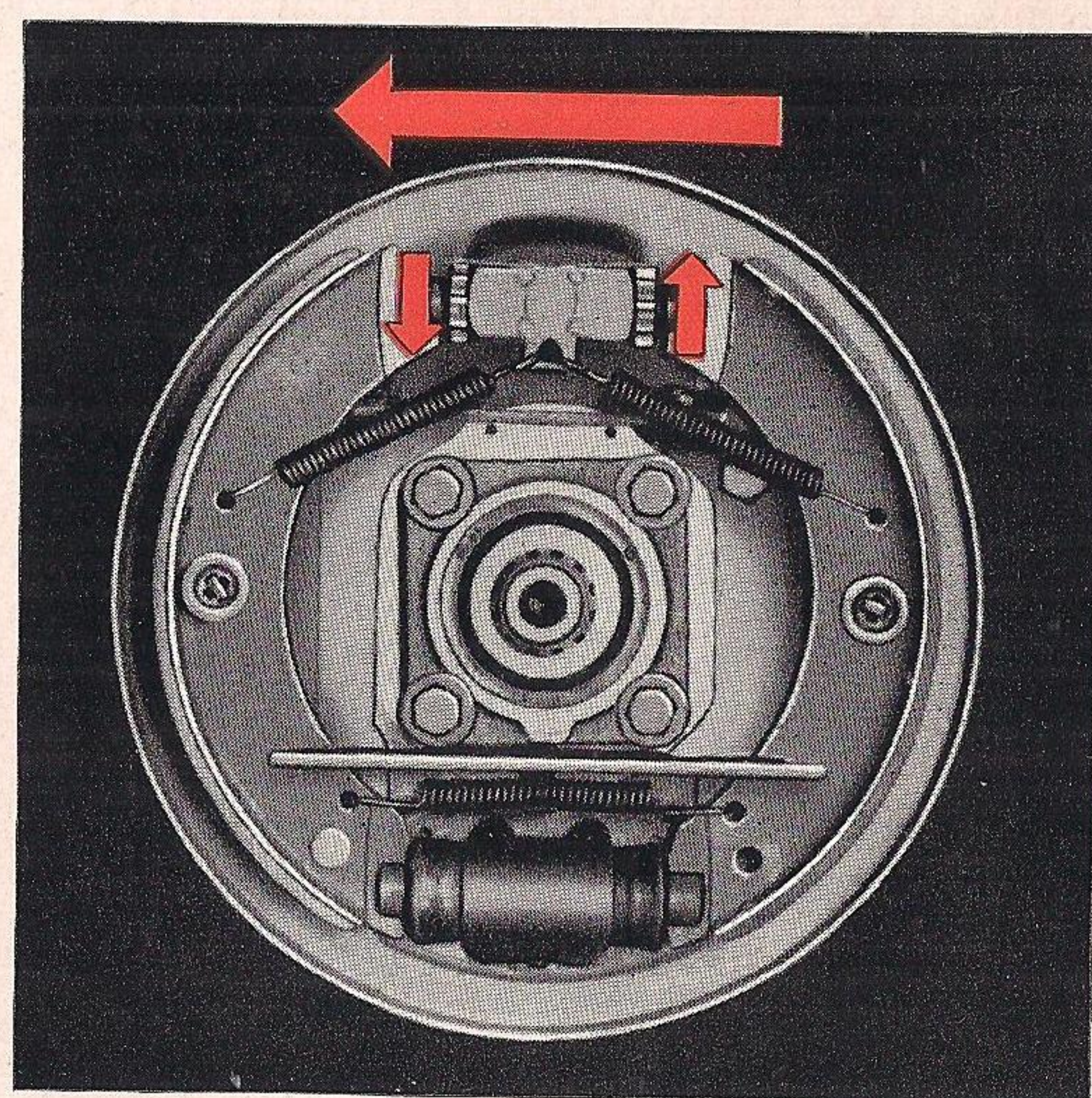
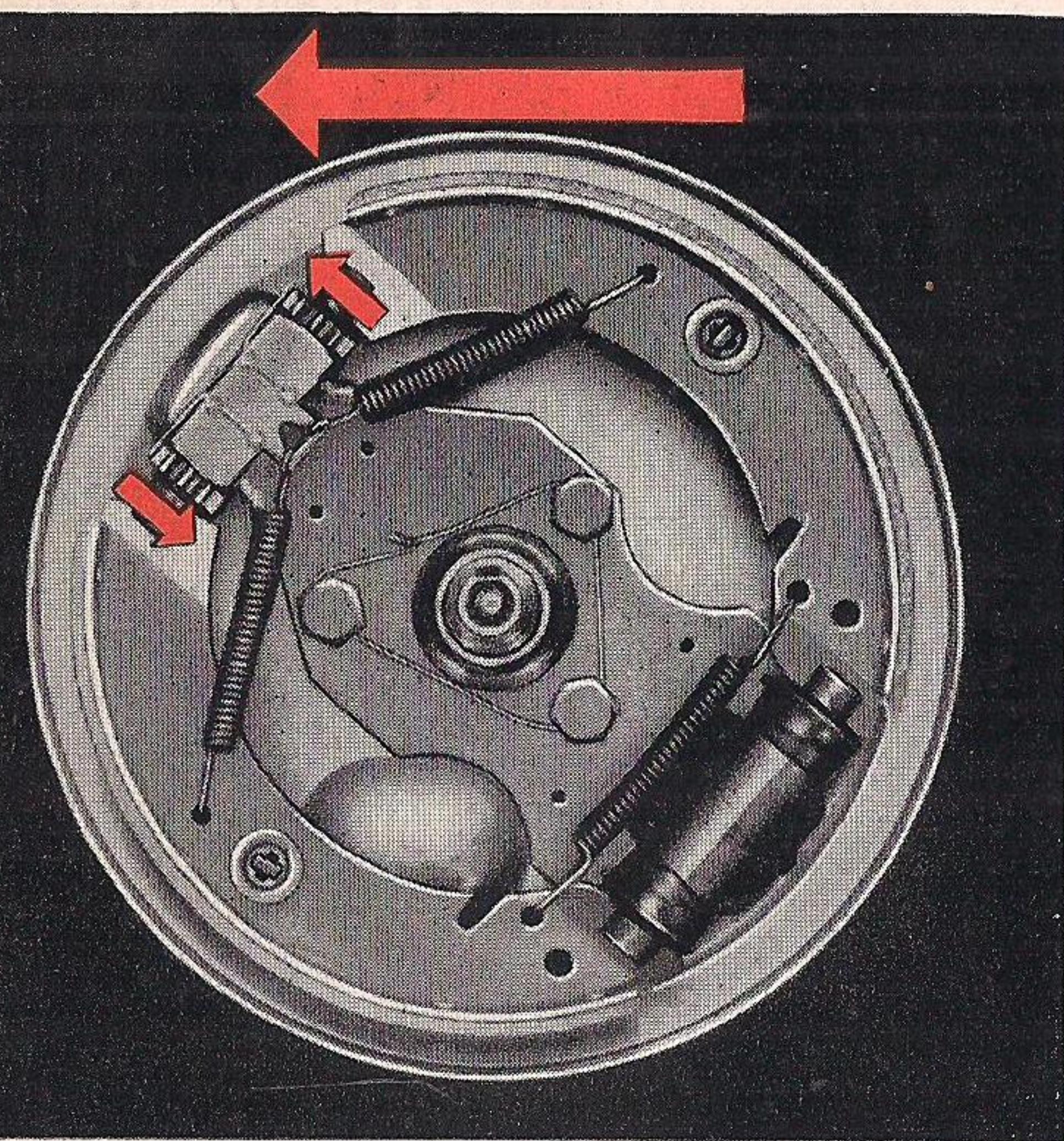

3 - Repeat procedure on the other adjusting nut. Note the opposite turning direction of the two nuts.

4 - Back off the adjusting nuts by 3 to 4 teeth.

5 - Repeat the above operations on the other wheels.

When adjusting the rear brakes, the hand brake must be released.

Adjusting Hand Brake

1 - Jack up both rear wheels.

2 - Fold back hand brake lever rubber boot to gain access to the adjusting nuts.

3 - Tighten adjusting nuts on the front ends of the brake cables to a degree which will still allow the rear wheels to turn freely when the hand brake is released.

4 - Pull up hand brake lever by two notches and make sure both rear wheels have the same braking effect. At the fourth notch it should be impossible to turn the wheels by hand.

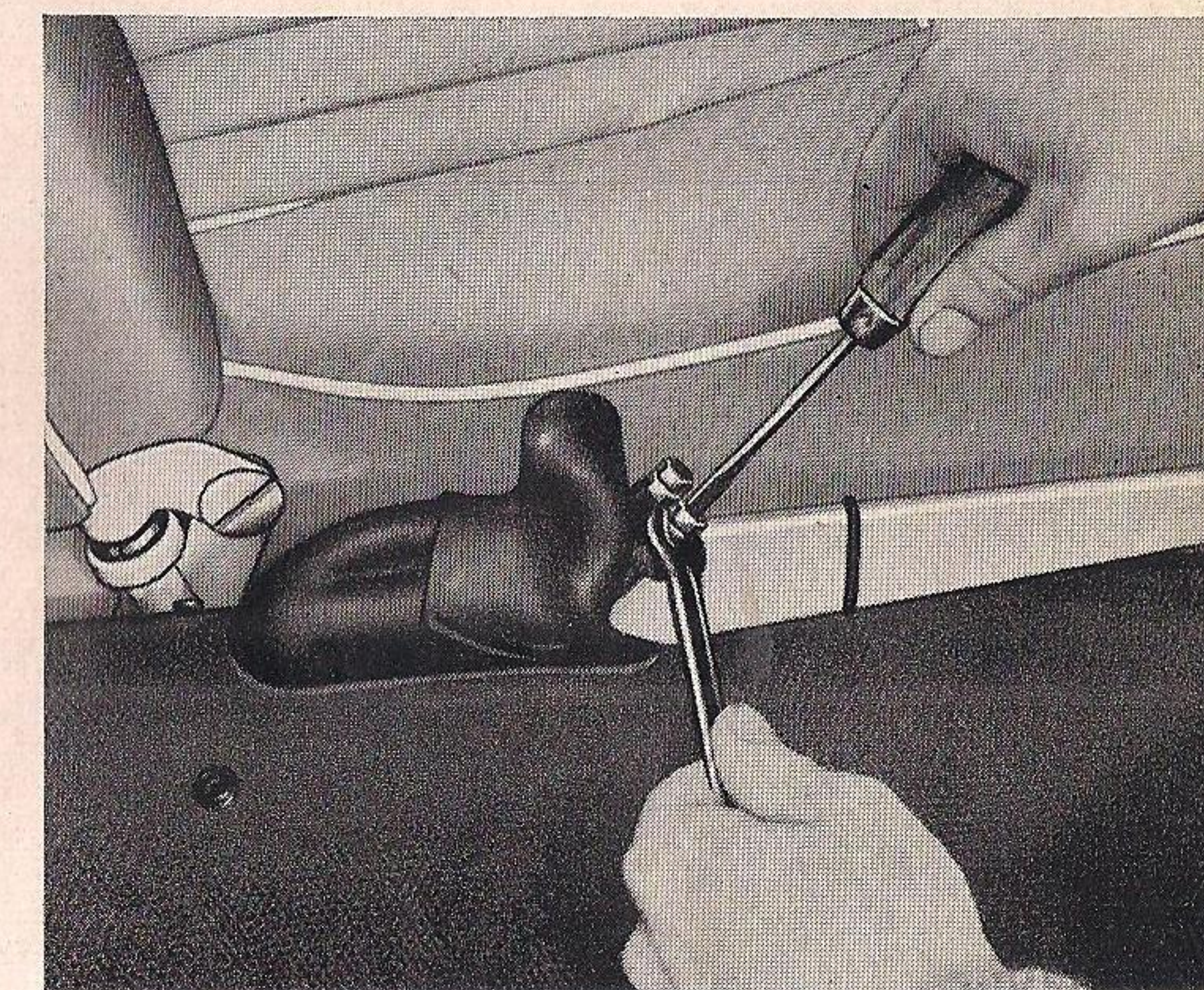

Steering Gear

The need for adjustment will be evidenced by the development of excess free play in the steering wheel. The play should be as small as possible, but care must be taken to allow the front wheels to resume their straight-ahead position automatically after the car has completed a turn. As special experience is needed to properly service this unit, all operations or adjustments required should only be performed by an Authorized VW Dealer. If, however, a workshop is out of reach, proceed as follows:

1 - Turn the front wheels to the straight-ahead position.

2 - Loosen lock nut and sector shaft adjusting screw on top of the steering gear case.

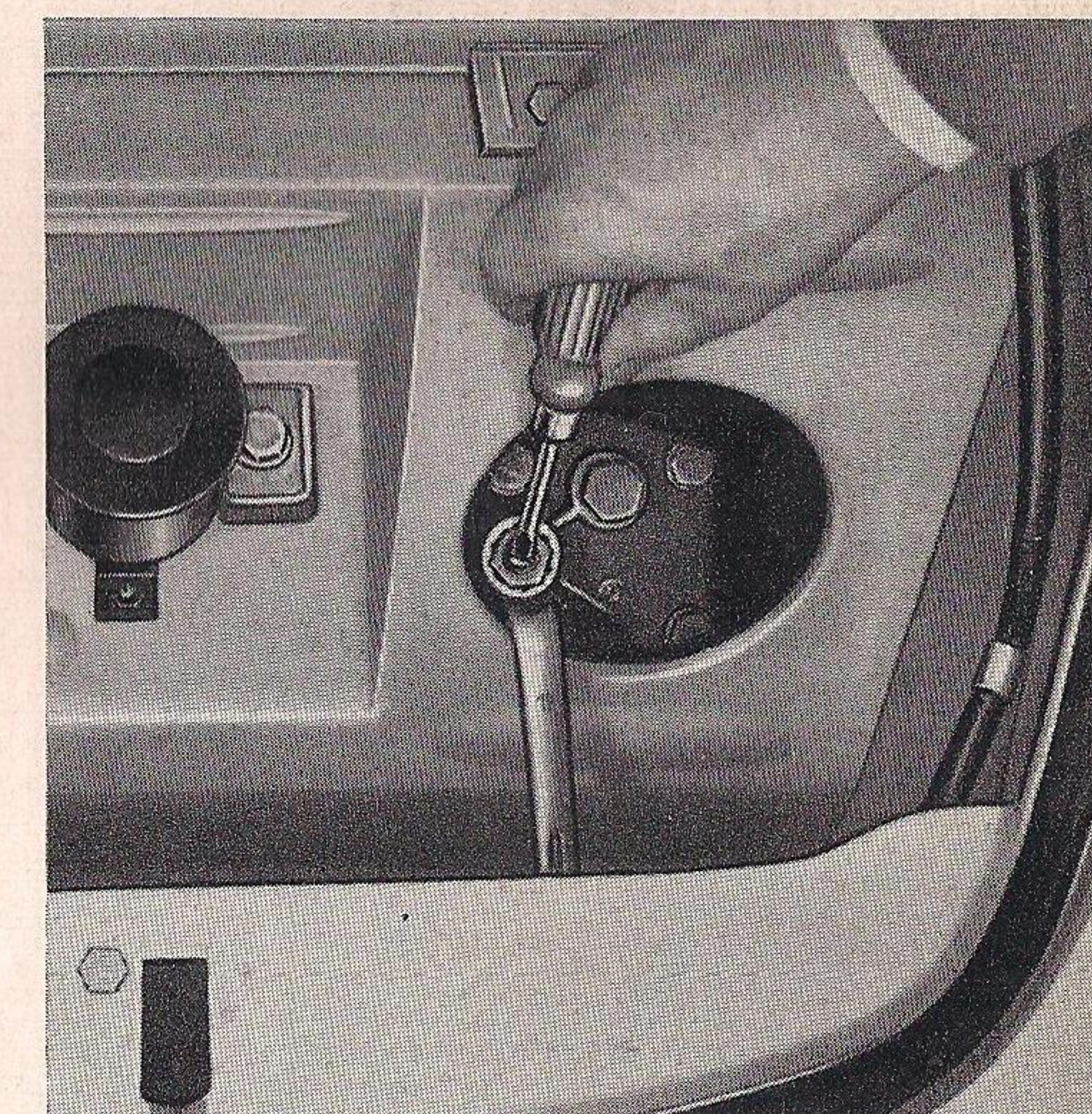

- 3 - Adjust worm shaft end play: Loosen adjusting sleeve clamping screw and tighten adjusting sleeve clockwise until the worm shaft end play is taken up. Tighten adjusting sleeve clamping screw.
- 4 - Adjust sector shaft end play: Tighten adjusting screw as far as it will go and back it off $\frac{1}{8}$ turn.
- 5 - The adjusting nut is to be secured in position by the lock nut after the adjustment has been completed.
- 6 - After having completed adjustments with the car supported on trestles, check the steering for binding by turning the steering wheel in both directions as far as it will go.

The maintenance service provides the regular adjustment of the torsion arm link pins on the front axle. After this operation it is absolutely necessary to check the toe-in of the front wheels.

Front Wheel Bearings

The front wheel bearings will occasionally require adjustment. We recommend to refer this operation to an Authorized VW Dealer, as mal-adjustment may cause severe damage to the bearings.

If circumstances require a removal of a front brake drum, the front wheel bearings are to be adjusted as outlined below:

Tighten inner nut until the thrust washer just allows to be moved laterally by a screwdriver and no bearing play can be felt when rocking the brake drum. Too loose or too tight an adjustment may ruin the bearings in a short time.

Finally, secure the nuts by bending down the lock plate.

GENERAL DESCRIPTION

Engine

The engine, located in the rear of the car, is mounted in a floating way on the recessed flange of the rubber-cushioned transmission case. Two pairs of cylinders are horizontally opposed. Each pair has a common cylinder head made of light alloy. The overhead valves are located in the cylinder head and are operated by a camshaft via push rods and rocker arms. The short and counter-balanced crankshaft rests in four replaceable special light alloy bearings and is heat-treated at its four points of support. It drives the camshaft by means of helical gears. The connecting rods are fitted with replaceable steel-backed lead-bronze bearings. The pistons are made of aluminum alloy.

A down-draft carburetor with accelerator pump produces the fuel-air mixture to supply the cylinders. The engine is equipped with battery ignition.

The spark advance is controlled automatically in two ways, by a centrifugal advance mechanism and a vacuum advance mechanism to assure proper functioning of the ignition under all operating conditions.

The oil pump of this full pressure lubrication system is driven by the camshaft and it sucks the oil from the crankcase bottom through a strainer, from where it will reach the points of lubrication via an oil cooler. In cold weather, when the oil is of higher viscosity, an oil pressure relief valve makes it possible for the engine to be lubricated directly, that is, by avoiding the oil cooling system. The air cooling of the engine is effected by means of a fan, which is attached to the extended generator shaft and driven from the crankshaft by an adjustable V-belt. The fan sucks in air through an opening in the fan housing, and the air cools the engine by passing through fins. A thermostat controls and regulates the amount of cooling air and insures wellbalanced operating and heating temperatures.

Transmission and Rear Axle

Power from the engine is transmitted to the gears via a dry single-disc clutch. The transmission case incorporates four speeds forward, one reverse, and the differential.

The car is equipped with synchromesh devices for the 2nd, 3rd, and 4th gears. The gears are helically cut to provide silent operation.

The drive pinion and the ring gear are cut spirally. The two swinging rear axle shafts are flexibly supported in the differential housing.

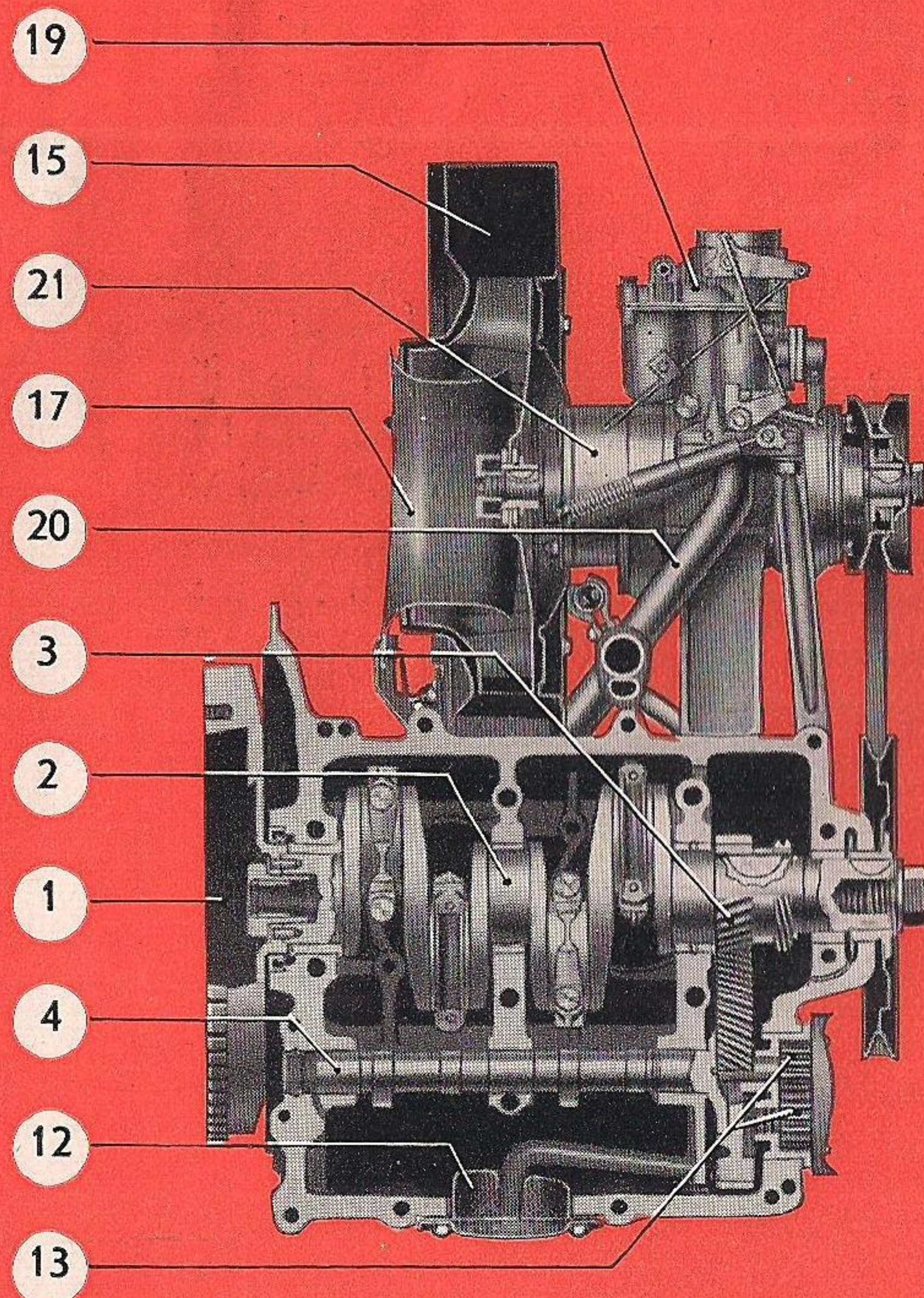
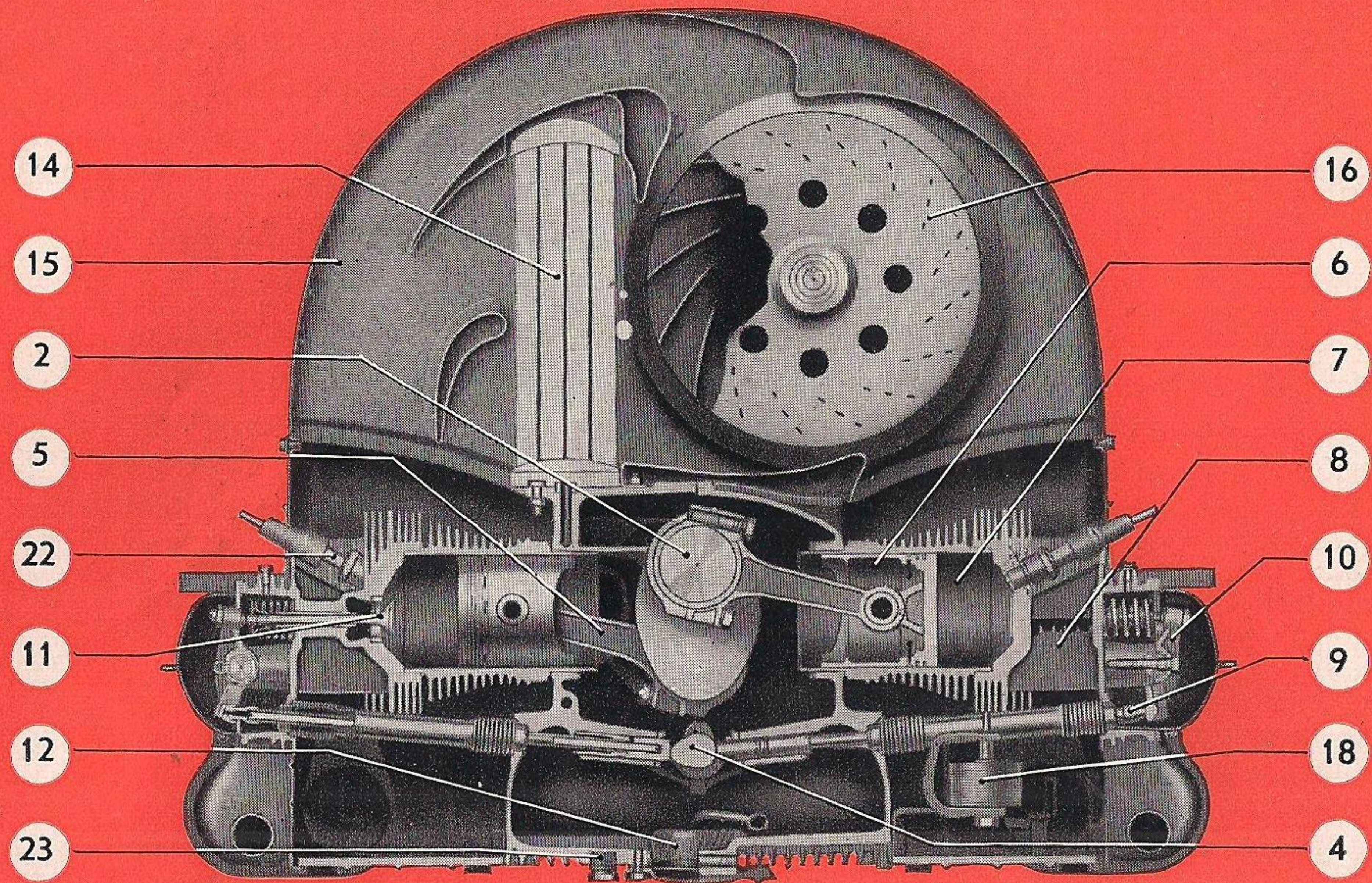

Engine

- 1 Flywheel
- 2 Crankshaft
- 3 Crankshaft Timing Gear
- 4 Camshaft
- 5 Connecting Rod
- 6 Piston
- 7 Cylinder
- 8 Cylinder Head
- 9 Valve Push Rod
- 10 Rocker Arm
- 11 Valve
- 12 Oil Strainer
- 13 Oil Pump
- 14 Oil Cooler
- 15 Fan Housing
- 16 Fan
- 17 Throttle Ring
- 18 Thermostat
- 19 Carburetor
- 20 Intake Manifold
- 21 Generator
- 22 Spark Plug
- 23 Oil Drain Plug

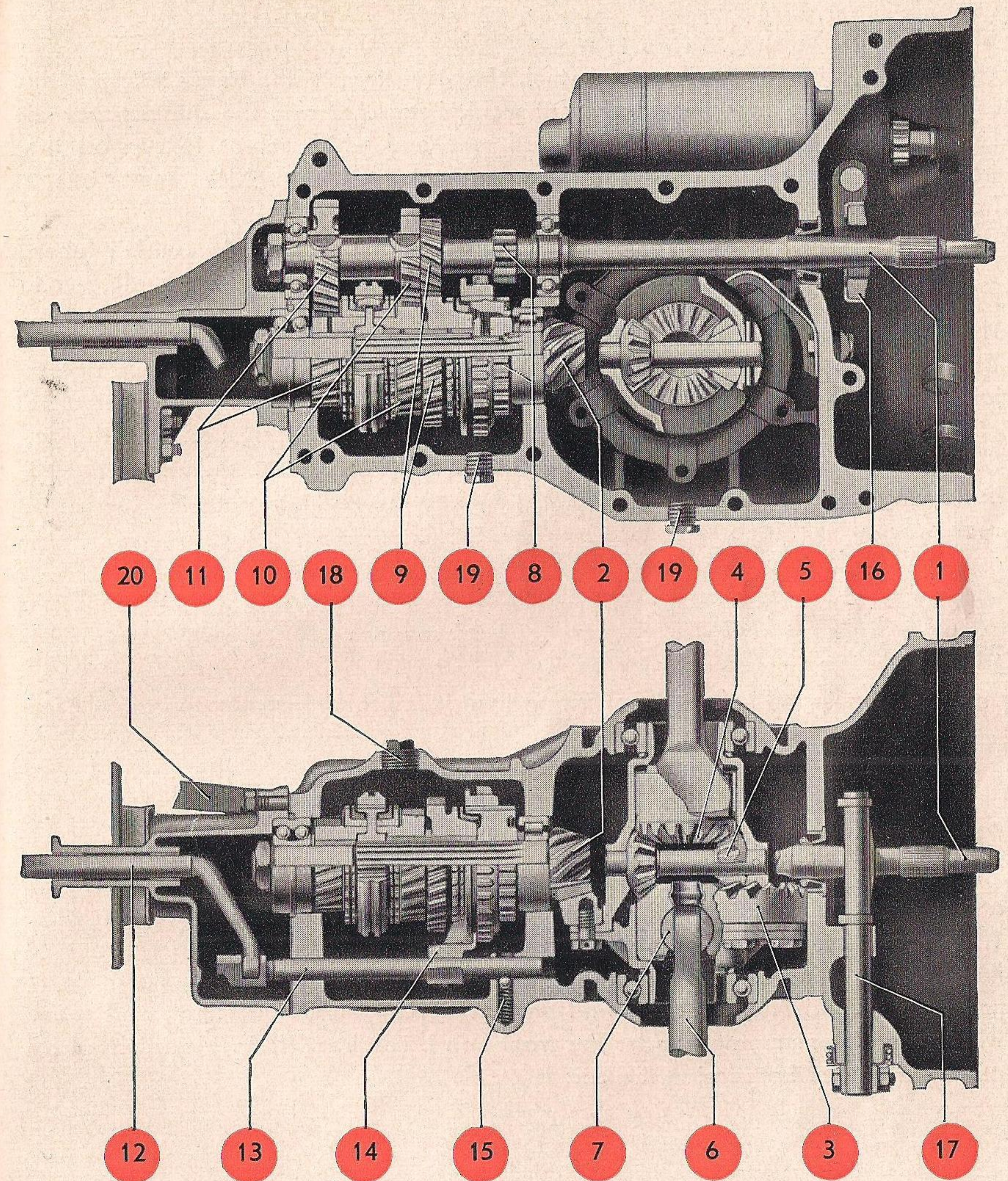

Rear Axle and Transmission

- | | | |
|--------------------------|---------------------------|---------------------------|
| 1 Main Drive Shaft | 8 1st Speed | 15 Detent Ball and Spring |
| 2 Drive Pinion | 9 2nd Speed | 16 Clutch Release Bearing |
| 3 Ring Gear | 10 3rd Speed | 17 Clutch Operating Shaft |
| 4 Differential Side Gear | 11 4th Speed | 18 Oil Filler Plug |
| 5 Differential Pinion | 12 Transmission Shift Rod | 19 Oil Drain Plug |
| 6 Rear Axle Shaft | 13 Selector Shaft | 20 Ground Strap |
| 7 Fulcrum Plate | 14 Selector Fork | |

Chassis

The frame of the car is of pressed steel. The steel floor of the frame is formed in two pieces. These two pieces are spot welded together with the channel-shaped center section of the frame, the forked rear end which serves to support the transmission and engine unit. The following parts pass through the center of the frame:

Gearshift rod, hand brake linkage, fuel line, and, in conduit tubes, the cables of brakes, clutch, throttle, choke, and warm-air heating unit.

The front suspension is an independent parallel arm type, using torsion bar springs. The front axle is bolted to the front end of the frame and consists of two rigidly joined tubes, which carry the torsion bar springs and the upper and lower arms of the front wheel suspension. The rear axle is of the swinging half axle design. The rear wheels likewise are independently sprung, using one individual torsion bar spring on each side. Double-acting hydraulic shock absorbers in front and rear prevent excessive rebound.

Brakes

The car is equipped with a direct acting hydraulic brake operating on all wheels.

Body

The two-door body, having the sweeping lines of a pontoon, is made up of pressed steel panels electrically welded together. The wings are welded to the body. The doors contain window regulator mechanisms. The front seats and the rake of their backrests are adjustable to suit individual requirements. Luggage space is provided behind the rear seats and under the front hood. Fuel tank and spare wheel are accommodated under the front hood. The hood locks are released by pulling at knobs from inside the car.

Heating System

Heated air, which is taken from the air flow warmed up by the engine, is emitted through two openings at the foot level and two defroster vents at the windshield. The heating system can be controlled from the driver's seat by means of a rotary knob. The two ventilators allow an individual regulation by two levers below the instrument panel. The air flows enter the interior through the two defroster vents at the windshield. Thus, fresh air can be mixed with the heated air in the desired proportions.

TECHNICAL DATA

Engine

Design	4 Cylinder, 4 Cycle, O.H.V.-Type, in rear of car
Arrangement of Cylinders	Horizontally opposed (Flat Four)
Bore	77 mm. (3.031")
Stroke	64 mm. (2.520")
Capacity	1192 c.c.
Compression Ratio	6.6
Valve Clearance	Intake 0.10 mm. } to be (.004") } adjusted Exhaust 0.10 mm. } when Engine (.004") } is cold
B. h. p. (SAE)	36 at 3700 R.P.M.
Lubrication	Force Feed (Gear Pump) with Oil Cooler
Oil Capacity	Metric — 2.5 liters U.S. — 5.3 pints Imp. — 4.4 pints
Fuel Pump	Diaphragm Type
Carburetor	Down-Draft Type, Solex 28 PCI
Cooling System	Air Cooling by Fan, Thermostat-controlled
Battery	6 Volts, 66 Ampere Hours
Starting Motor	Electric, 6 Volts, .5 HP.
Generator	Voltage regulated, 6 Volts, 160 Watts at 2500 R. P. M.
Ignition Distributor	Centrifugal and Vacuum Spark Advance
Firing Order	1—4—3—2
Spark Timing	7.5° before T.D. C.

Breaker Point Gap	0.4 mm. (.016")	
Spark Plugs	Bosch W 225 T 1	} 14 mm.
	Beru 225/14 u 2	
	Lodge H 14 or HN	
	Champion L 10 S	
	AC 43 L	
	Auto-Life AE 6 or AER 6	
	KLG F 70	
Spark Plug Gap	0.6 to 0.7 mm. (.024" to .027")	

Clutch

Design	Single Disc, dry
Pedal Free-Play	10 to 20 mm. (1/2—1")

Transmission

4 Speeds Forward, 1 Reverse, 2nd, 3rd, and 4th Gears Synchronized and Helically Cut for Silent Operation.

Gear Ratios	First	3.60 : 1
	Second	1.88 : 1
	Third	1.23 : 1
	Fourth	0.82 : 1
	Reverse	4.63 : 1

Rear Axle

Power is transmitted through a spiral drive pinion and ring gear, via two swinging axles to the rear wheels.

Ratio	4.4 : 1
Oil Capacity of Transmission and Rear Axle	Metric — 2.5 liters
	U. S. — 5.3 pints
	Imp. — 4.4 pints

Chassis

Front Suspension	Two Laminated Torsion Bars Passing through Front Axle Beams
	One stabilizer bar
Rear Suspension	One Round Torsion Bar for Each Rear Wheel
Shock Absorbers	Double Acting Hydraulic Type, Front and Rear
Steering	Worm Steering Gear, divided Tie Rod
Turns of Steering Wheel, Lock to Lock ...	2.4
Turning Circle	11 meters (36 ft.)
Wheels	Disc Wheels 4 J X 15, Drop-Center Type
Tires	5.60—15. tubeless

Inflation Pressure		
1 to 2 Occupants	Front: 1.1 kg./cm. ²	Rear: 1.4 kg./cm. ²
	16 lbs./sq. in.	20 lbs./sq. in.
Fully loaded	Front: 1.2 kg./cm. ²	Rear: 1.6 kg./cm. ²
	17 lbs./sq. in.	23 lbs./sq. in.
Wheel Base	2400 mm. (7 ft. 10.5 in.)	
Track (Tread)	Front: 1290 mm. (4 ft. 3 in.)	
	Rear: 1250 mm. (4 ft. 1.2 in.)	
Toe-in (car unloaded)	1 to 3 mm. (0.04 in. to 0.12 in.)	

Brakes

Foot Brake	Hydraulic Brake, Operating on All Wheels
Hand Brake	Mechanical, Operating on Rear Wheels

Dimensions and Weights

Length	4140 mm. (163")
Width	1630 mm. (64.2")
Height	1325 mm. (52.2")
Road Clearance	155 mm. (6.1")
Net Weight	790 kg. (1742 lbs.)
Weight, ready for use	810 kg. (1786 lbs.)
Maximum Carrying Capacity	300 kg. (661 lbs.)
Permissible total Weight	1110 kg. (2447 lbs.)
Max. Axle Loads	Front 450 kg. (992 lbs.)
	Rear 660 kg. (1455 lbs.)

Fuel Consumption

Nominal Consumption on normal Roads ..	Metric — 7.5 liters per 100 km.
	U. S. — 32 miles per gallon
	Imp. — 38 miles per gallon
Fuel	Min. Octane Number 76 (Res. F 1)
Oil Consumption	Between 0.03 and 0.1 liter per 100 km.

Capacities

Fuel Tank	40 liters (10.5 U.S. gall.; 8.8 Imp. gall.)
Engine	2.5 liters (5.3 U.S. pints; 4.4 Imp. pints)
Rear Axle and Transmission	2 liters/Refilling quantity
	(4.2 US. pints; 3.5 Imp. pints)
Steering Gear Case	0.125 liter (0.26 U.S. pint; 0.22 Imp. pint)
Brake	0.25 liter (0.5 U.S. pint; 0.4 Imp. pint)
Air Cleaner	0.25 liter (0.5 U.S. pint; 0.4 Imp. pint)

Performance

Maximum and Cruising Speed	115 km. (72 m. p. h.)
Hill-Climbing Ability	First Speed 34 % (18.5°)
	Second Speed 17 % (9.5°)
	Third Speed 10.5 % (6°)
	Fourth Speed 5.5 % (3°)

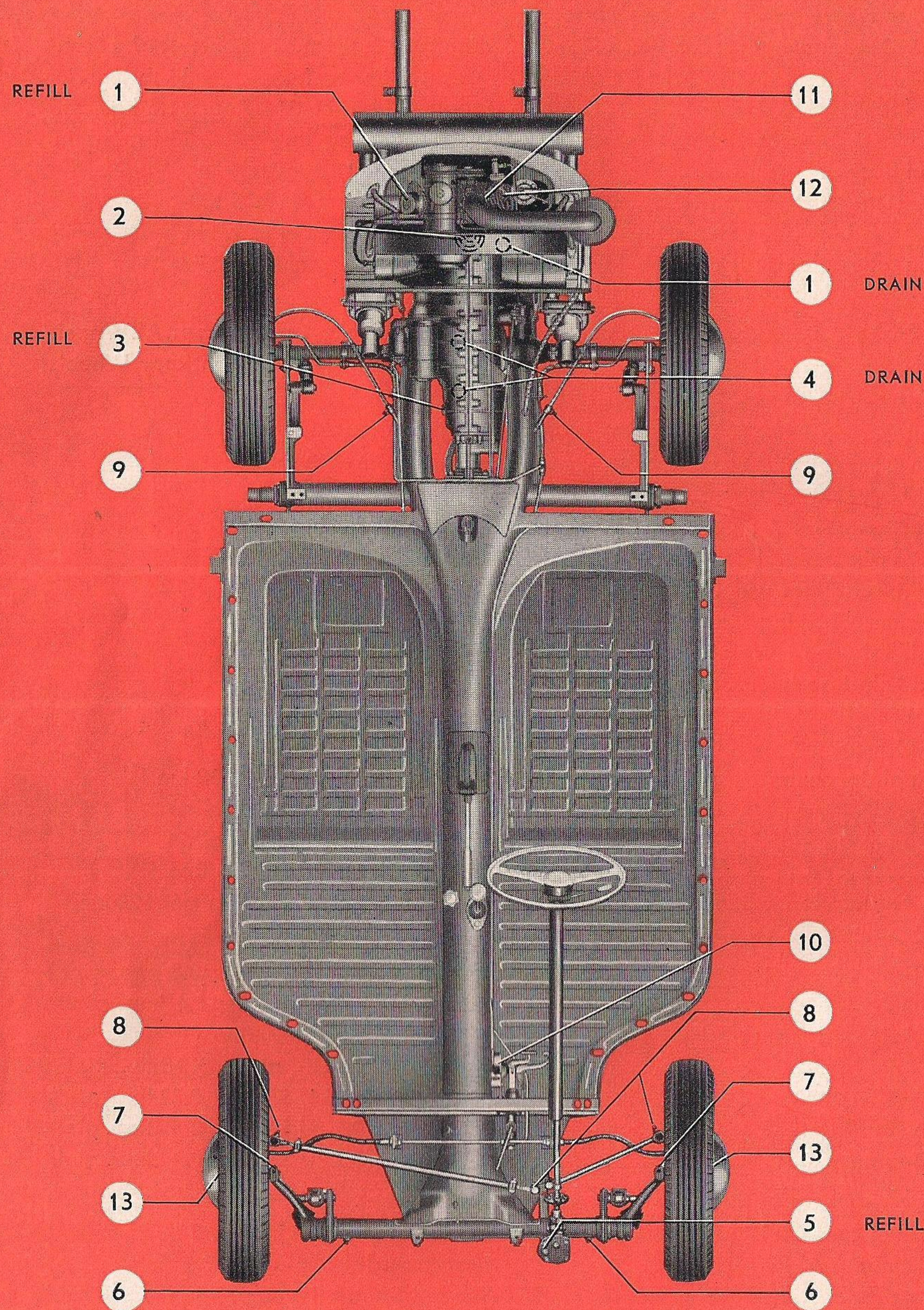

LUBRICATION CHART

At km./miles km. miles 500 3000	No.	Lubrication points	Mark	Every
	6	Engine: Check oil level, top up if necessary	M	2500 km. 1500 miles
	6	Front axle tubes	F	
	7	King pins	F	
	8	Tie rod ends	F	
		Door hinges	M	
	1	Engine: Change oil	M	5000 km. 3000 miles
	2	Engine: Clean oil strainer		
	3	Transmission: Check oil level	G	
	5	Steering gear: Check oil level	G	
	9	Brake cables	F	
	10	Pedal cluster	F	
	11	Carburetor controls	M	
	12	Breaker arm fiber block in distributor	F	
		Hood locks	F	
	4	Transmission: Change oil	G	25 000 km. 15 000 miles
	13	Front wheel bearings	F	
	12	Cam bearing in distributor	M	

LUBRICANTS

Lubricant	Lubrication points	Mark	Specifications		
			Temperature C	F	
Engine oil (HD oil for Otto-cycle engines)	Engine, carburetor controls, door hinges, cam bearing in distributor	M	above +30°	+86°	SAE 30
			from 0°	+32°	SAE 20 or
			up to +30°	+86°	SAE 20 W
			below 0°	+32°	SAE 10 W
Gear oil	Transmission case, steering gear	G	above 0°	+32°	SAE 90
			below 0°	+32°	SAE 80
Universal grease	Front axle, tie rod ends, front wheel bearings, brake cables, pedal cluster bearing, gear lever, breaker arm fiber block, hood locks	F	Anti-freeze, water-repellent grease		

MAINTENANCE CHART

At km./miles			Operation	Every
km. 500	miles 300	2500 1500		
			Clean air cleaner	5000 km.
			Check and adjust fan belt	
			Clean carburetor Check carburetor adjustment	
			Check breaker points and ignition timing	
			Check valve clearance	
			Examine battery	
			Check operation of lights, signals, and instruments	
			Check generator	
			Check spark plugs and compression	
			Check front wheel bearings, front suspension, steering, and toe-in	
			Check tire pressures and tighten wheel bolts From 5000 km (3000 miles) onwards, rotate tires	
			Test brakes	
			Check tightness and effect of shock absorbers	
			Check clutch pedal clearance	
			Coat weather strips for doors and windows with powdered talc	3000 miles
			Check automatic cooling air control	
			Inspect rear axle and engine for oil leaks	
			Engine, especially exhaust, carburetor, intake manifold, and fuel pump	
			Chassis, body, front axle, rear axle, and steering	10 000 km.
			Check tightness of nuts and bolts	
			Engine, especially exhaust, carburetor, intake manifold, and fuel pump	6000 miles
			Chassis, body, front axle, rear axle, and steering	

INDEX

	Page		Page
Accelerating — correct and wrong	19	Engine — number	6
Accelerator pedal	5	— oil change in winter	24
— accelerating	19	— oil level	7
Accessories	III	— oil strainer	27
Air cleaner — cleaning	41	— speed	61
Ash receiver	16	— sectional view	58
		— technical data	61
		— type of oil	28
Battery — maintenance	52	Fan belt — adjusting	42
— capacity	61	— checking tension	8
— care in winter	25	Foot brake — adjusting	53
Body — airing the interior	40	Fresh air ventilators	15
— description	60	Front axle — description	60
Brakes — adjusting	54	— lubrication	34
— application	13	— technical data	62
— bleeding	53	Front seats — adjustment	14
— care in winter	24	— lubrication of seat runners	33
— checking	10	Front wheel bearings — adjusting	56
— description	60	— lubrication	31
— topping up	53	Fuel consumption	63
Brake pedal	5	Fuel pump — type	61
Breaking-in (running-in) period?	18	Fuel tank — capacity	63
		— reserve	63
Carburetor — adjusting	44	Fuel tap positions	8
— cleaning	43	Fuse boxes	48
— type	61	Fuses — exchanging	49
Care of the car	36		
Chassis — care in winter	24	Gear lever	5
— description	60	— lubrication	33
— lubrication	31	Gear shifting on gradients	19
Chassis number	6	General description	57
Choke control knob	5	Generator	61
— application	11	Ground clearance	63
Chromium-plated parts — care	39		
Climbing ability	63	Hand brake — adjusting	55
Clock	5	Headlights — aiming	50
Clutch — design	62	— changing bulb	49
— pedal	5	Heating — description	60
— pedal free play	62	— operation	23
Cold weather hints	23	Hood — front	17
Controls and instruments	5	— rear	17
Cooling of engine	61	Horn button	5
Dimensions — overall	63	Idling — checking and adjusting	44
Dimmer switch — headlight	5	Ignition — breaker point gap	47
Direction indicator lever	5	— distributor	61
Direction indicator lights — replacing bulbs	51	— firing order	61
Doors — care of weather strips	40	— lubrication of distributor	29
— inside handle	5	— timing	47/61
— lubrication points	32	Instrument light	10
Driving off	12	Interior light	16
Driving down-hill	14		
		Jack — application	34
Economy	19	— location	17
Emergency seats — backrest	15	Key — doors and ignition	6
Engine — compression ratio	61		
— description	57		
— design	61		
— lubrication (oil change)	26		

	Page
License plate light — replacing bulb	51
Light switch — positions	10
Lubricants	65
Lubrication	26
Lubrication Chart	65
Maintenance	41
Maintenance Chart	66
Maximum output	61
Maximum speed	63
Non-skid chains	25
Oil consumption	63
Oil level — engine	7
— steering gear	30
— transmission	30
Paintwork — preservation	37
— polishing	38
Parking your car	22
Passing other cars	21
Practical driving	18
Ratios — rear axle	62
— transmission	62
Rear axle — description	57
— technical data	62
Rear view mirror	21
Reverse gear	12
Safety in traffic	21
Seat adjustment	14
Shifting gears	12
Shock absorbers — design	62
Spare wheel	34
Spark plugs — checking and cleaning	46
— gap	46/62
— makes	62
— removal	46
Speedometer	5
Speed ranges	18
Spots — removal	38
Starting — danger in closed rooms	11
— in winter	11
— with engine cold	11
— with engine hot	11
Starting motor	61
Steering — adjusting	55
— lubrication	30
— type	62

	Page
Steering wheel	5
— turns from lock to lock	62
Stop light — bulb replacement	51
— checking	10
Stopping the car — generally	14
— temporarily	21
Suspension — front	62
— rear	62
Tail light — replacing bulb	51
Technical data	61
Tires — inflation pressure	9/63
— maintenance	34
— M + S tires	25
— size	62
— wear	34
Toe-in of front wheels	63
Tools and accessories	III
Track (tread)	63
Transmission — description	57
— oil change and capacity	29/30
— oil change in winter	24
— sectional view	59
— technical data	62
Turning circle	62
Type of fuel	63
Upholstery, care of — imitation leather	39
— leather	39
Valves — adjusting	45
— arrangement	61
— clearance	61
Ventilators	15
— description	60
Warning lights — direction indicator	20
— generator and cooling	20
— headlight	20
— oil pressure	20
— replacing bulbs	51
Washing your car	36
Weights	63
Wheel base	63
Wheels — balancing	34
— changing	34
— rim size	62
Window regulator — lubrication	32
Window regulator handle	5
Window weather strips — care	40
Windshield wiper switch	5

Tools and Accessories

- 1 Fan Belt
- 1 Tool Bag
- 1 Spare Wheel, complete
- 1 Jack
- 1 Combination Pliers
- 1 Screwdriver 0.8 mm.
- 1 Screwdriver 0.5 mm.
- 1 Open End Wrench 8/12 mm.
- 1 Socket Wrench for Spark Plug, Wheel Disc Bolt, and Fan Pulley Nut
- 1 Socket Wrench 14 mm.
- 1 Rod for Socket Wrench and Jack

C A U T I O N
DO NOT OVERFILL BATTERY
 Proper Liquid Level Is 1/2 Inch Above Plate
Overfilling May Result In Acid
Damage To Floor Trim!

NORTH IMPORT MOTORS, Inc.
 3638 - 42 N. SOUTHPORT
 CHICAGO 13, ILLINOIS
 WE. 5-2200

The manufacturer

reserves the right to make any changes in or improvements on its products without imposing any liability or obligation upon itself to install them on its products previously manufactured.

All rights reserved in accordance with the law of copyright.

KARMANN • englisch