

POLY-PAD IMPORTS

1965 Accessory Guide

"Keep Your Volkswagen Young"

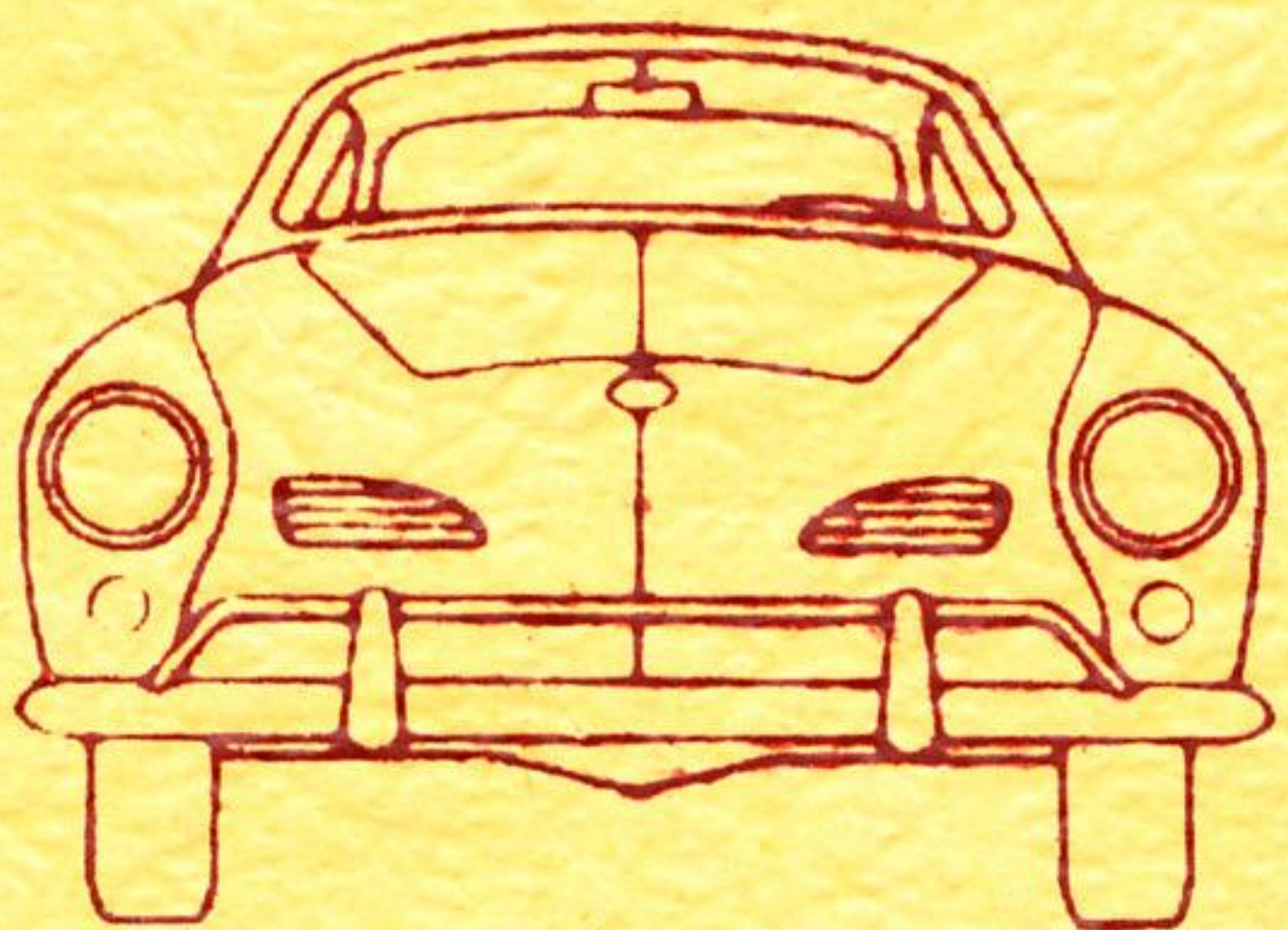

\$1.00

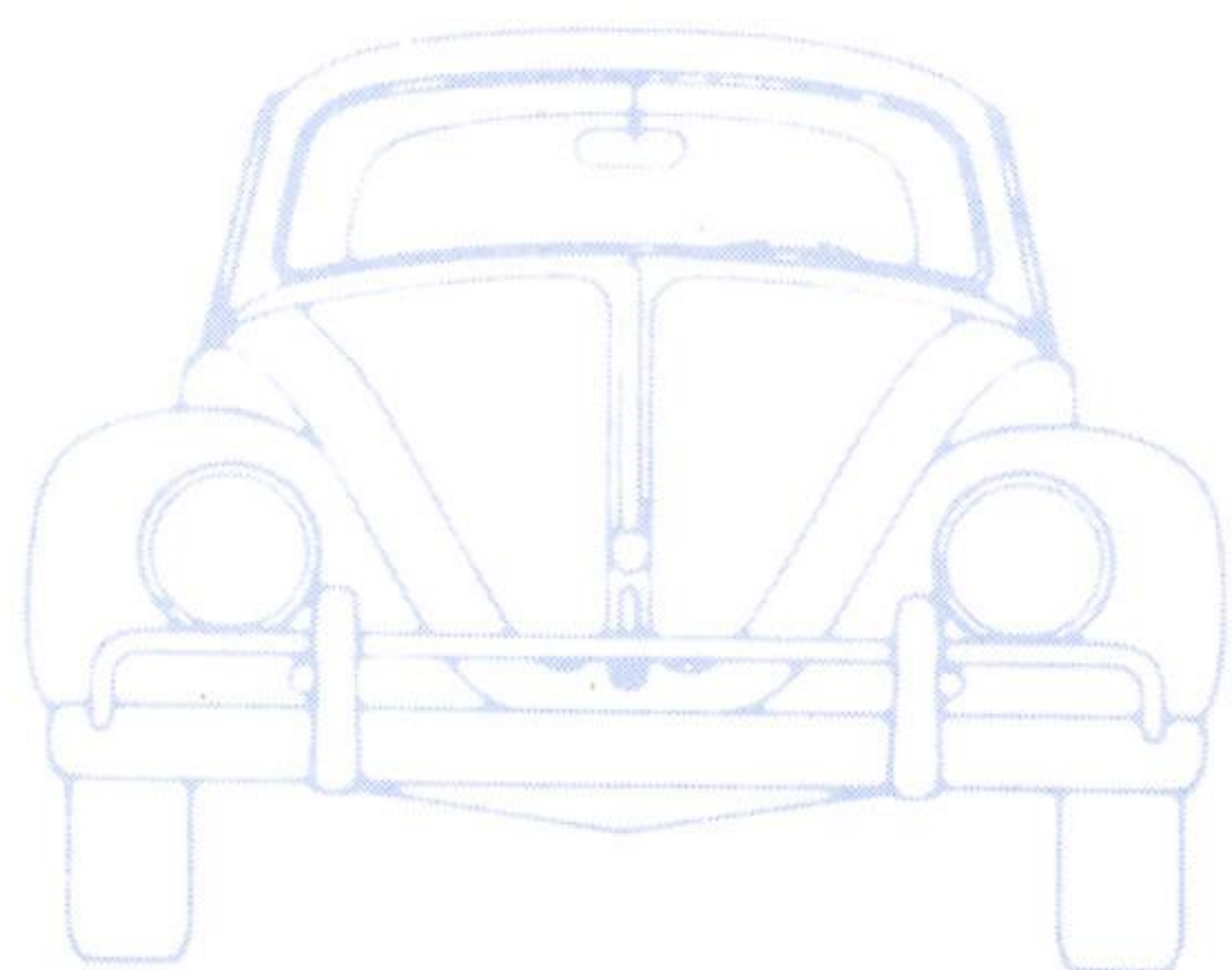

POLY PAD IMPORTS

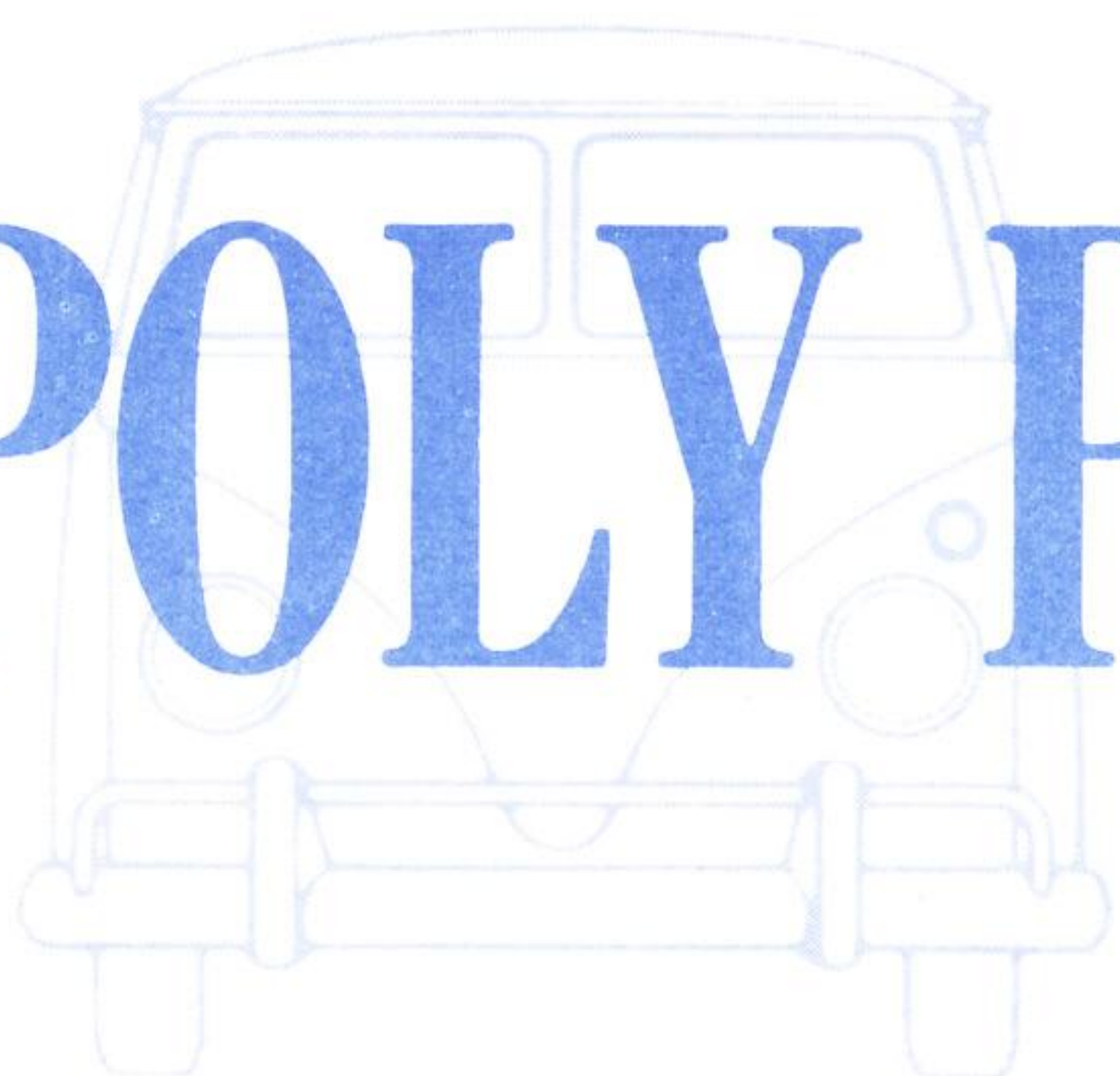

1965 Accessory Guide

"Keep Your Volkswagen Young"

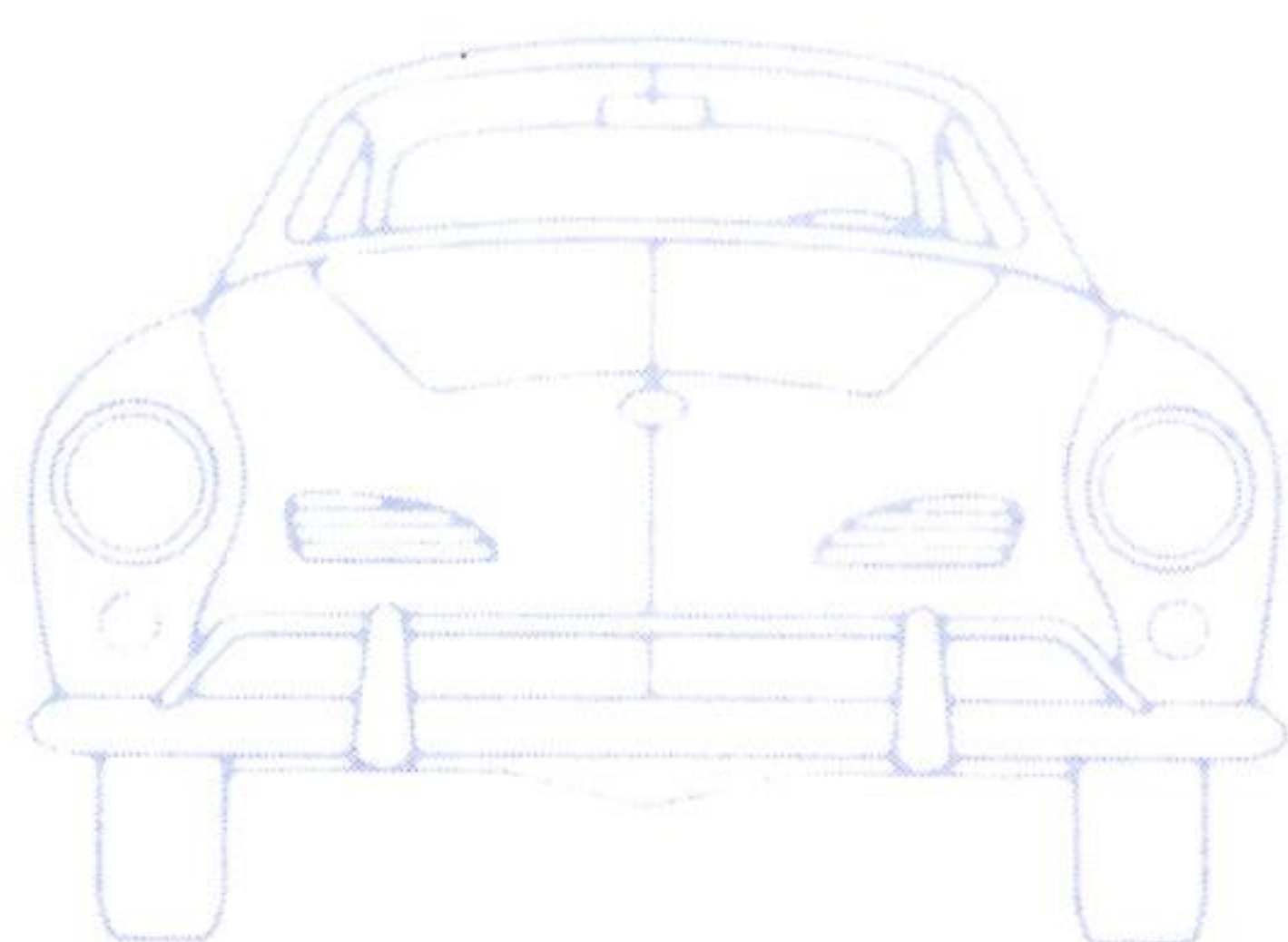

POLY PAD IMPORTS
DIVISION OF MAX G. FELDER & SON, INC.



ACCESSORIES FOR THE VOLKSWAGEN OWNER
811 PROSPECT AVENUE, CLEVELAND, OHIO 44115 U.S.A.
PHONE: 621-0773 (AREA CODE 216)

February 15, 1965

Dear Friend:

In the following pages we present a comprehensive collection of ideas to increase your motoring pleasure and to add a greater margin of safety to it. A good number of the products shown relate to the performance of your car; while we do not catalog "speed" equipment, we do recommend many items for the maintenance of the manufacturer's original specifications and for generally improving roadability.

Poly Pad Imports was born of an interest in one of the world's most unique automobiles, the Volkswagen, and of an ambition to create products for it that would complement its fine engineering features and, in some small way, help it gain the respect it richly deserved.

To that end, we have always strived to catalog for you many sensible accessories that have a specific purpose; pure and simple "gingerbread" has been shunned in favor of practicality. We research each item intended for this catalog and actually use it on one of several company-owned Volkswagens. Each must pass a personal-use test before it can be considered for publication, and each must contribute significantly to the use and enjoyment of a Volkswagen to be acceptable. Quality of manufacture and durability are prime considerations. We unearth many, many items on our buying trips to Europe, but more are rejected than are accepted because they fall short of meeting our stringent qualifications.

It is our hope that this Accessory Guide provides you with interesting reading and some useful information. Poly Pad Imports appreciates your interest and welcomes your comments or suggestions. If you have any questions about items listed, we will give your inquiries our immediate attention!

Yours very truly,

POLY PAD IMPORTS

A handwritten signature in cursive script that reads "Harlan L. Felder".

Harlan L. Felder
President

HLF:MLE

MANUFACTURERS • IMPORTERS • DISTRIBUTORS OF QUALITY AUTOMOTIVE PARTS

POLY PAD IMPORTS

811 PROSPECT AVENUE • CLEVELAND, OHIO 44115

<u>A</u>	<u>OUR NO.</u>	<u>PAGE</u>	<u>F</u>	<u>OUR NO.</u>	<u>PAGE</u>
ACCELERATOR COVER.....	660.....	7	FADER CONTROL, SPEAKER.....		32
ADJ. REAR WINDOWS.....	576.....	16	FENDER FLAPS.....	26.....	20
AERO-TACH DECAL.....	36.....	28	FLOOR MATS.....		3,4
AIR CONDITIONER.....	V139W.....	11	FOG LIGHTS.....	9900.....	27
AIR HORN.....	1132.....	26	FUEL FILTER.....	103.....	25
AMBER LENSES.....		26	FUSES.....	108.....	29
"AMERICAN" RADIO.....		31			
ANTENNAS.....	709.....	30	<u>G</u>		
ANTENNAS, BOSCH.....		32	GAS CAN, RESERVE.....	355.....	14
ANTI-GLARE MIRRORS.....		12, 13	GASKETS, VALVE COVER.....	3960, 3940.....	25
ANTI-GLARE SHIELD.....	891.....	13	GAUGE, TIRE PRESSURE.....	509.....	33
ARM REST, CENTER.....	730.....	5	GEAR SHIFT KNOBS.....		10
ARM REST, DRIVER'S SIDE.....	412.....	5	GEAR SHIFT LEV. EXT.....	1421, 1421S.....	10
AXLE BOOT.....	27.....	23	GLASSES, VW DRINKING.....	G-6.....	38
			GLOVE BOX PULL.....	18.....	8
<u>B</u>			GLOVE COMPARTMENT DIV.....	565.....	8
BACK-UP LIGHTS.....		27	GRANDE GRILLE.....	29.....	19
BAMBUS SHELF.....		9	GRAVEL GUARDS.....	7150, 6650.....	18
BED CONVERSION.....	1050.....	6	GREASE GUN, WANNER.....	315, 316.....	33
BEER STEIN, VW.....	265, 266.....	38	GRILL, HORN.....		19
BELTS, SAFETY.....		6	GUARD, HOOD HANDLE.....	48.....	19
BLAUPUNKT RADIOS.....		31	GUARDS, DOOR HANDLE.....	646, 647.....	17
BLOWER, HEATER.....		11	GUARDS, HEADLIGHT.....	394.....	19
BOGE SHOCK ABSORBERS.....		23	GUTTER TRIM.....	160.....	16
BOGE STEERING DAMPER.....	8700.....	23			
BOOKS.....		37	<u>H</u>		
BOOT, AXLE.....	27.....	23	HAND SPOTLIGHT.....	F3070.....	26
BOSCH ANTENNAS.....		32	HANDLE GUARDS, DOOR.....	490.....	17
BRACKET, LICENSE PLATE.....	64.....	20	HANDLE GUARDS, HOOD.....	48.....	19
BRAKE GRIP, EMERGENCY.....	149.....	5	HANGER, CLOTHES.....		5
BRAKE LINING, RIVET. SET.....	824.....	34	HEAD & SHOULDER REST.....	750.....	4
BUG & GRAVEL SCREEN.....	125.....	18	HEADLAMP VISORS.....	126.....	19
BUMPERS.....	1095, 1096.....	21	HEADLIGHT GUARDS.....	394.....	19
BUMPER BANGERS, BUS.....	28.....	21	HEAT SEALS.....	35.....	29
BUMPERS, DOOR.....	172.....	17	HEATER BLOWER KITS.....		11
BUMPER, RUBBER INSERTS.....	10, 12.....	21	HEATERS, GASOLINE.....		11
BUMPER STIFFENERS.....	1090.....	21	HIGH BEAM SWITCH.....	9600.....	28
			HITCHES, TRAILER.....	134, 135.....	21
<u>C</u>			HINGE PIN MIRRORS.....		13
CAMBER COMPENSATOR.....		23	HORN, ELECTRIC AIR.....	1132.....	26
CAMPING BED CONVERSION.....	1050.....	6	HORN GRILL.....		19
CAN, RESERVE GAS.....	355.....	14	HOSE CLAMP PLIERS.....	2141.....	34
CARBURETOR JET HEATER.....	60.....	25	HUB CAPS.....		11
CARRIERS, LUGGAGE.....		22			
CLOTHES BAR.....		5	<u>I</u>		
CLYMER BOOKS.....		37	ILLUMINATED COMPASS.....	810.....	28
COMBINATION SERV. WRENCH.....		34	INSTALLATION KITS, RADIO.....		31
COMPASS, ILLUMINATED.....	601.....	28	"INSTANT" HEATER.....		11
CONNECTOR KITS, MUFFLER.....		24			
CONNECTOR PIPES, MUFFLER.....		24	<u>J</u>		
COVERS, SEAT.....		1, 2	JET HEATER, CARB.....	60.....	25
CUTTER, VALVE SEAT.....		34	JOKON BACK-UP LIGHT.....	260, 261.....	27
<u>D</u>			<u>K</u>		
DAMPER, BOGE STEERING.....	8700.....	23	KNOBS, GEAR SHIFT.....		10
DASH, PADDED.....	1099.....	4			
DEFROSTER SHIELDS.....	393.....	11	<u>L</u>		
"DERBY" RADIO.....		31	LAMPS, 6-VOLT SEAL BEAMS.....	6006.....	27
DOOR BUMPERS.....	172.....	17	LENSES, AMBER.....		26
DOOR HANDLE GUARDS.....	646, 647.....	17	LICENSE PLATE BRACKET.....	64.....	20
DOOR LATCH COVERS.....	490.....	17	LIGHTER/MAP LIGHT COMB.....	601.....	28
DOOR PILLAR GUARDS.....	320.....	8	LIGHTS:		
DOOR PULLS.....	983.....	8	BACK-UP/JOKON.....	260, 261.....	27
DOOR-TO-DOOR FLOOR MAT.....	9470.....	4	BACK-UP/SEDAN.....	13.....	27
DRAIN PLUG, MAGNETIC.....	1000.....	25	BACK-UP/TRANSPORTER.....	491.....	27
DRINKING GLASSES, VW.....	G-6.....	38	HAND SPOTLIGHT.....	F3070.....	26
DRIVER'S ARM REST.....	412.....	5	SEE-THRU FOG LIGHT.....	9900.....	27
DRIVES, RATCHET.....		35	UTILITY LIGHT.....	14.....	26
DRIVER'S SHELF.....	20.....	9	LOCK, VENT WINDOW.....	21.....	8
DRYCAPS.....	707.....	29	LOCKING ENG. COMP. HANDLE.....	45.....	19
			LOUVER TRIM.....	912, 917.....	20
<u>E</u>			LUGGAGE CARRIERS.....		22
ELECTRIC AIR HORN.....	1132.....	26	LUGGAGE SPYDER.....	104.....	22
ELECTRICAL SYSTEM ITEMS.....		29			
ELFRINK BOOKS.....		37			
EMERGENCY BRAKE GRIP.....	149.....	5			
EMPI CAMBER COMPENSATOR.....		23			
ENGINE COMPARTMENT LOCKS.....	276.....	19, 20			
EPOXY STEERING WHEEL.....	65.....	7			
EXTENSION, GEAR SHIFT LEV.....	1421, 1421S.....	10			
EZ SET TUNE-UP TOOL.....	F-4.....	33			

1965 CATALOG

I N D E X

POLY PAD IMPORTS

811 PROSPECT AVENUE • CLEVELAND, OHIO 44115

<u>M</u>	<u>OUR NO.</u>	<u>PAGE</u>
MAGNETIC DRAIN PLUG.....	1000.....	25
MAP LIGHT/LIGHTER COMB.....	601.....	28
MATS, FLOOR.....		3,4
METRIC TOOLS.....		36,38
MIRRORS:		
HINGE PIN.....		13
NON-GLARE.....		12,13
REAR VIEW/INSIDE.....		12
REAR VIEW/OUTSIDE.....		13,14
SUN VISOR/PRIMP-UP.....		12
MOLYKOTE FLUID CONCENTRATE.....		33
MUD GUARDS.....	26.....	20
MUFFLERS.....	5560,6064.....	24
MUFFLER CONNECTOR KITS.....		24
MUFFLER CONNECTOR PIPES.....	24.....	24
MUFFLER PIPES.....	23.....	24

N

NEOPRENE VALVE COVER GASKETS..	3960,3940.....	25
--------------------------------	----------------	----

O

OFFSET WHEELS.....		13
OIL PRESSURE SWITCH.....	615.....	29
OUTSIDE MIRRORS.....		13,14

P

PADDED DASH UNIT.....	1099.....	4
PARCEL SHELVES.....		9
PERFECTION GASOLINE HEATER.....		11
PILLAR GUARDS, DOOR.....	320.....	8
PIPES, CONNECTOR.....	24.....	24
PIPES, MUFFLER.....	23.....	24
PLIERS, HOSE CLAMP.....	2141.....	34
POLY PLAID Wool Seat Cov.....		1,2
PORSCHE-STYLE WHEELS.....		13
PORTABLE RADIOS, BLAUPUNKT.....		31
PULL, GLOVE BOX.....	18.....	8

Q

QUICKSHIFT.....	1500.....	10
-----------------	-----------	----

R

RADIOS, CAR.....		30,31
RADIOS, PORTABLE.....		31
RAIN GUTTER TRIM.....	160.....	16
REAR SEAT SPEAKERS.....		32
REAR SHELVES.....		9
REAR VIEW MIRRORS.....		12,14
REAR WINDOWS, ADJUSTABLE.....	576.....	16
RESERVE GAS CAN.....	355.....	15
RUBBER BUMPER INSERTS.....	10,12.....	21
RUNNING BOARD TRIM.....		16

S

ST. CHRISTOPHER MEDAL.....	22.....	4
SCHAFFER CLAW.....	404.....	16
SCREEN, BUG & GRAVEL.....	125.....	18
SEALED BEAM LAMPS.....	6006.....	27
SEALS, HEAT.....	35.....	29
SEAT BELTS.....		6
SEAT BELT ADAPTER.....	705.....	6
SEAT COVERS.....		1,2

1965 CATALOG

I N D E X

S cont'd

<u>OUR NO.</u>	<u>PAGE</u>	
SEAT RECLINER.....	1040..... 6	
SEE-THRU FOG LIGHTS.....	9900..... 27	
SHADES (VENTSHADES).....		17
SHELVES.....		9
SHIELDS, DEFROSTER.....	393..... 11	
SHIFT EXTENSIONS.....		10
SHIFT KNOBS.....		10
SHOCK ABSORBERS, BOGE.....	8400,8500..... 23	
SHOULDER BELTS.....		6
SIGNAL LEVER COVER.....	643..... 7,28	
SOCKETS, METRIC.....		35
SPARK PLUG CABLE SET.....	1325..... 29	
SPEAKERS, RADIO.....		32
SPOTLIGHT, HAND.....	F3070..... 26	
SPYDER, LUGGAGE.....		22
STEERING DAMPER, BOGE.....	8700..... 23	
STEERING WHEEL GLOVE.....	1080..... 7	
STEERING WHEEL, EPOXY.....	65..... 7	
STEINS, VW BEER.....	265,266..... 38	
STEPS FOR TRANSPORTERS.....		14
SUN VISOR MIRROR.....	34..... 12	
SUPPRESSION KITS.....		32
SWITCH, FOG LIGHT.....	9901..... 27	
SWITCH, HIGH BEAM.....	9600..... 28	
SWITCH, OIL PRESSURE.....	615..... 29	
SWITCH, STOPLIGHT.....	600..... 29	

T

TACHOMETER DECAL.....	36..... 28	
TAIL PIPE TRIM.....	179,182..... 24	
TAPER TIPS.....	TRT-1..... 24	
THERMO-CAR JET HEATER.....	60..... 25	
THRESHOLD PLATES.....	42..... 16	
TILT-BACK SEAT RECLINER.....	1040..... 6	
TIRE GAUGE.....	509..... 33	
TOOLS:		
BRAKE LIN'G.RIVET.SET.....	824..... 34	
COMB. SERVICE WRENCH.....	400..... 34	
EZ SET TUNE-UP TOOL.....	F-4..... 33	
GREASE GUNS.....	315,316..... 33	
HOSE CLAMP PLIERS.....	2141..... 34	
METRIC SOCKETS & DRIVES.....		35
METRIC TORQUE WRENCH.....		34
METRIC WRENCHES.....		36
VALVE SEAT CUTTER.....		37
TRAILER HITCHES.....	134,135..... 21	
TRANSPORTER STEPS.....		14
TRIM, RAIN GUTTER.....	160..... 16	
TRIM, RUNNING BOARD.....		16
TRIM, VENT LOUVER.....	912,917..... 20	

U

UTILITY LIGHT.....	14..... 26
--------------------	------------

V

VALVE COVER GASKETS, NEOP....	3960,3940..... 25
VALVE SEAT CUTTER KIT.....	202AV..... 34
VENT LOUVER TRIM.....	912,917..... 20
VENT WINDOW DEFLECTOR.....	187..... 17
VENT WINDOW LOCK.....	21..... 8
VENTSHADES.....	V-1,V-1A..... 17

W

"WANNER"GREASE GUN.....	315,316..... 33	
"WELCOME!" FLOOR MATS.....		3
WHEEL RINGS.....		15
WHEELS, OFFSET.....	4000,4050..... 15	
WHEELS, PORSCHE STYLE.....	4000,4050..... 15	
WHEELS, STANDARD.....		15
WHEELS, STEERING.....	65..... 7	
WINDBREAKER.....	499..... 18	
WINDOWS, ADJ. REAR.....	576..... 16	
WINDSHIELD WIPER CONV.....	W102,W103..... 18	
WRENCH, COMB. SERVICE.....	400..... 34	
WRENCH, METRIC TORQUE.....	8072,8074..... 34	
WRENCHES, METRIC.....		36

Poly Plaid

WORLD FAMOUS

DELUXE WOOL SEAT COVERS

- Take the "sting" out of cold seats in winter, hot seats in summer!
- Add unusual eye appeal to your car!

• Now available for 1965 cars

• Striking new colors

This year, color your car *PLAID!* The original POLY PLAID Deluxe Wool Seat Covers do wonders for your car. In this country and abroad, the POLY PLAIDS have become a standard, because:

- They're handsome! Available in four beautiful color combinations, they complement interior colors of most cars and lend an individual flavor all their own.

- They do away with the "cold seat blues" in winter, and the burn of sun-baked seats in summer. Many people buy POLY PLAIDS in winter, only to find, surprisingly, that they are more comfortable than hot, vinyl seats during the summer too!

- They almost look like upholstery! They're superbly constructed from a marvelous wool blend, permanently laminated with a layer of plastic foam. This cushion makes the cover cling to the seat without wrinkling or slippage, and adds a great deal of comfort too. Expert tailoring techniques are used to insure long wear, precise fit.

- POLY PLAIDS are completely machine washable, easy to install and remove. Special elastic fastenings permit simple installation and easy removal for "housekeeping".

POLY PLAIDS are the best value on the market because we take great pride in them and put everything possible into making them a quality product! Look for, and insist upon, the POLY PLAID label!



See reverse side for complete model listings



Poly Plaid

DELUXE WOOL SEAT COVERS

Beauty - All Year Comfort

Easy to Install - Washable

NO.	MODEL		PRICE
VS-1	VW Sedan, Convertible, through 1964	Front Seat	\$ 9.95 per seat
VS-2	VW Sedan, through 1964	Rear Seat	15.95 complete
VS-165	VW Sedan, Convertible, 1965 models	Front Seat	9.95 per seat
VS-265	VW Sedan, 1965 models	Rear Seat	15.95 complete
VC-3	VW Convertible	Rear Seat	15.95 complete
KG-4	Karmann-Ghia, Sedan, Convertible	Front Seat	10.95 per seat
KG-5	Karmann-Ghia, Sedan, Convertible	Rear Seat	15.95 complete
TB-6	Transporter, Bench	Front Seat	19.95 complete
TD-7	Transporter, Bucket	Front Seats	19.95 per pair
TS-8	Transporter, adjustable split	Front Seats	21.95 complete
V-9	VW 1500 Sedan, Convertible	Front Seat	10.95 per seat
V-10	VW 1500 Sedan	Rear Seat	17.95 complete
V-11	VW 1500 Convertible	Rear Seat	17.95 complete
V-12	Variant	Front Seat	10.95 per seat
V-13	Variant	Rear Seat	17.95 complete
V-14	VW 1500 Ghia Sedan, Convertible	Front Seat	10.95 per seat
V-15	VW 1500 Ghia Sedan, Convertible	Rear Seat	15.95 complete

FOUR PLAID COLOR COMBINATIONS AVAILABLE

BLUE GRAY GREEN RED

Specify number, model, and color choice when ordering.



Inviting!

European!

Exclusive!

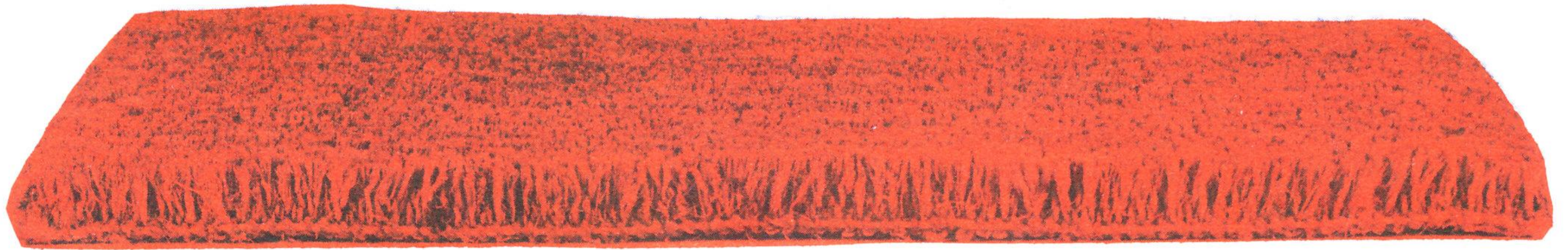
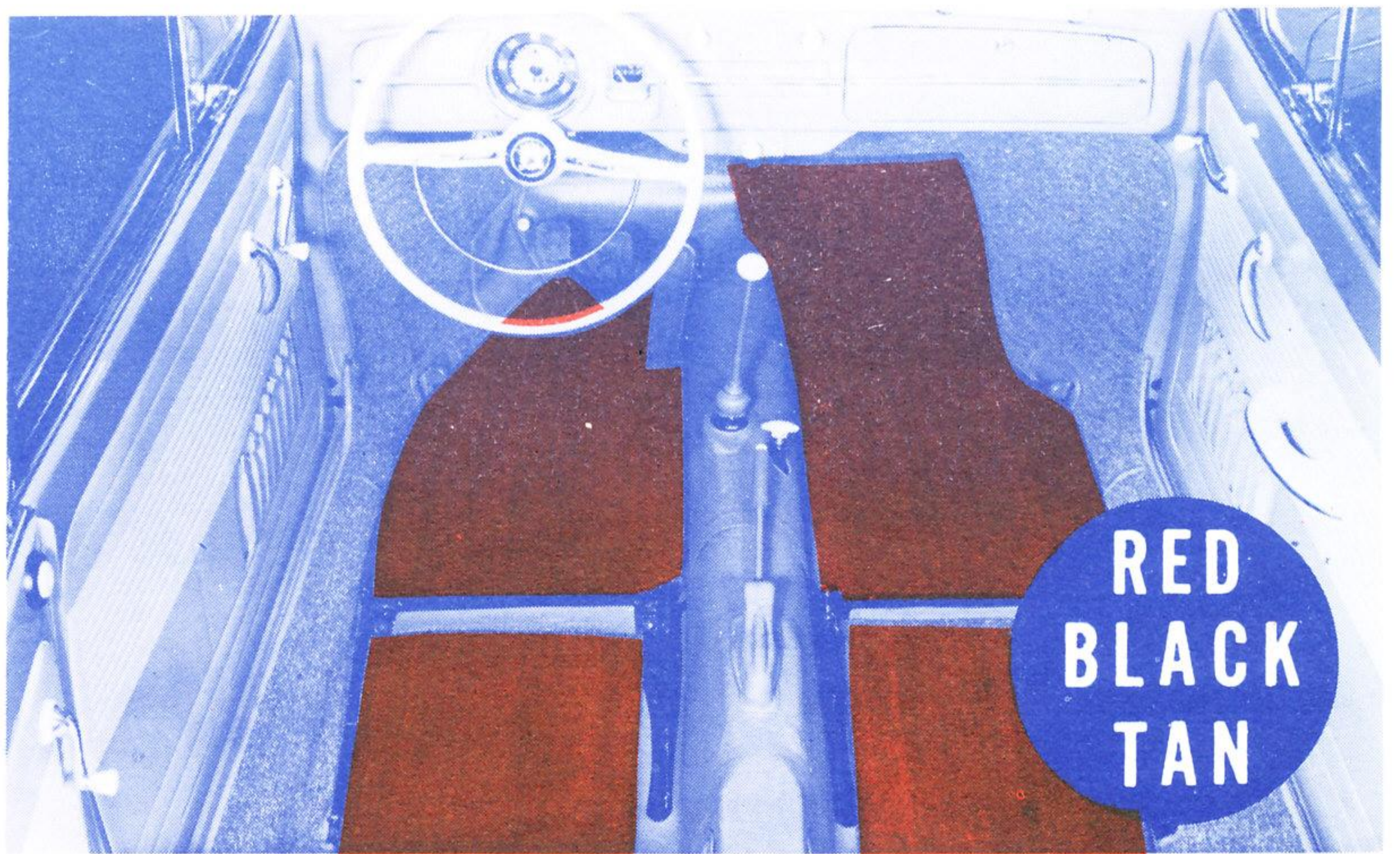

"WELCOME!" COCOA FLOOR MATS

Inviting, sensible floor mats for your car. Already popular all over Europe! *EXCLUSIVELY POLY PAD!*

LUXURIOUS — Tightly woven of choice, pure cocoa fibre, brush-cut to 3/4" depth.

ABSORBANT — Dense weave absorbs slush and dirt from shoes, keeps "mess" from penetrating to floor.

CUSTOM-TAILORED — Perfect fit for all VW's, most other foreign cars.

EASILY CLEANED — Simply lift out in separate sections, shake or beat out! Hose down if you like!

SOFTENS NOISE, VIBRATION — Deep weave absorbs road noise, cushions vibration.

YOU CAN'T WEAR 'EM OUT! Free replacement if they don't last the entire life of your car!

Order your new "Welcome!" mats today!

No.	Model		Price
CM-1	VW 1200 Sedan, Convertible	Complete Set	\$19.75
CM-2	VW 1200 Sedan, Convertible	Front only	10.95
CM-3	VW 1200 Sedan, Convertible	Rear only	8.95
CMT-4	Transporters thru 1964	Front only	14.75
CMT-5	Transporters, 1965 models	Front only	14.75
CMK-6	Karmann-Ghia 1200	Front only	18.50
CM-7	VW 1500 Sedan, Variant	Complete set	28.95
CM-8	VW 1500 Sedan, Variant	Front only	18.50
CM-9	VW 1500 Sedan, Variant	Rear only	10.50
CMS-10	Saab	Complete set	34.95
CMS-11	Saab	Front only	21.50
CMS-12	Saab	Rear only	13.50
CMC-13	Corvair	Complete set	35.95
CMC-14	Corvair	Front only	21.25
CMC-15	Corvair	Rear only	14.75
CMP-16	Porsche	Front only	15.95
CMB-17	Mercedes-Benz 190, 220	Complete set	30.95
CMB-18	Mercedes-Benz 190, 220	Front only	20.50
CMB-19	Mercedes-Bens 190, 220	Rear only	10.50

Please state car make, model and year when ordering



CUSTOM PADDED DASH

- Lessens danger of injuries
- Reduces glare
- Handsome, custom look

For safety and good looks, a single-unit dashboard that is padded and looks upholstered. Covered with flat-finish leather-like vinyl that reduces glare, this handsome unit attaches securely with 4 bolts, is far more permanent than adhesive types. Molded and formed to custom-fit all 1200 sedans, this unit installs easily, adds a lot to the looks of your Volkswagen. Complete with grab handle. An exclusive Poly Pad import from Europe.



No. 1099

\$17.95 each

DOOR-TO-DOOR FLOOR MAT

for Elegance, Quality, Service

These are super deluxe mats designed for VW Sedans and Convertibles. They are made from extra heavy "LIVE" rubber and feature an attractive "V" Gold Mylar emblem. Deep grooves catch dirt and water. Wear points are reinforced for extra long service. One style mat, with cut-out markings on the back, will fit the front or rear floor. Colors available: *black, red, green, blue, white or brown.*

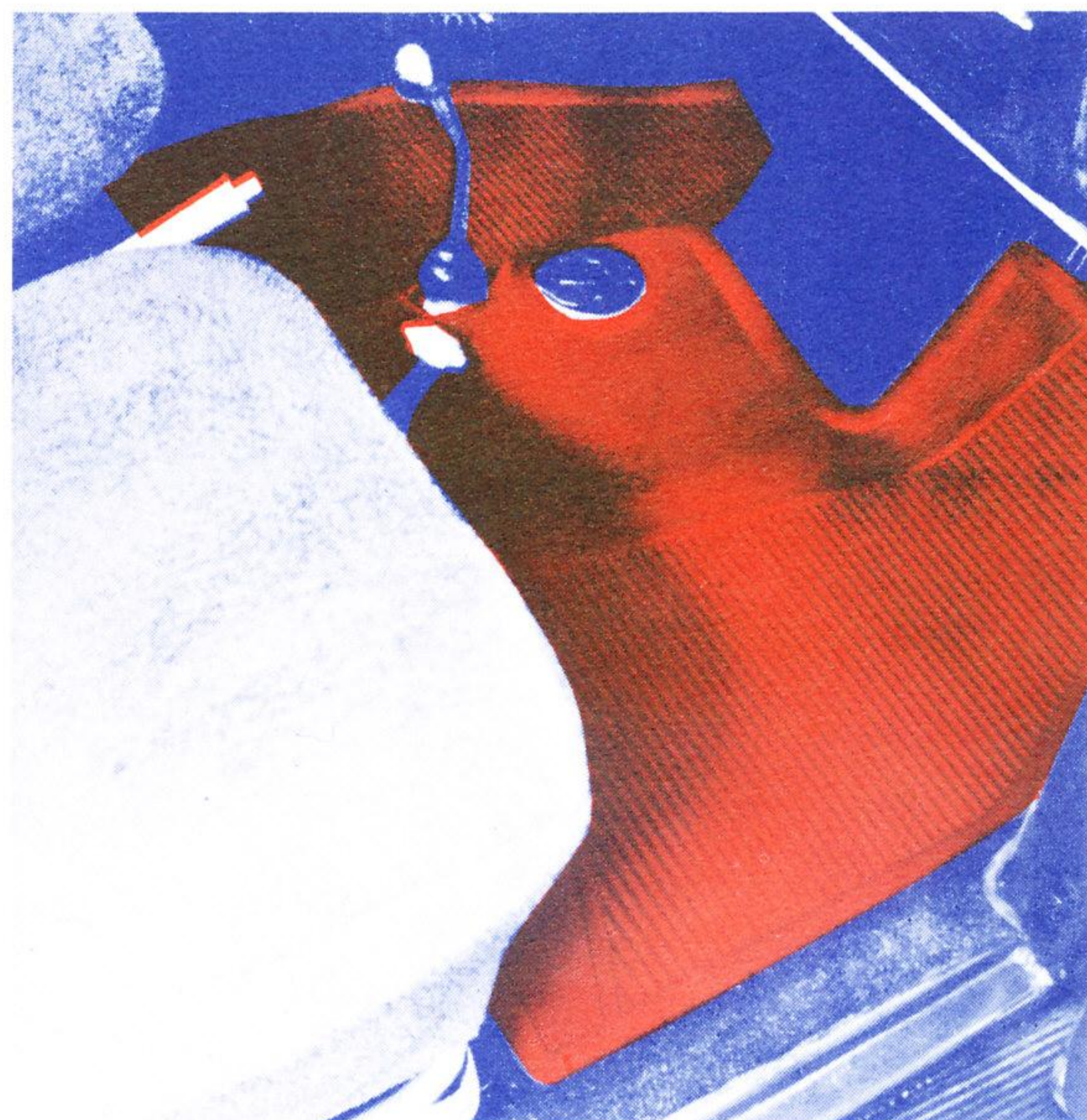

No. 9470

\$ 7.95 each

HEAD AND SHOULDER REST

Soft contoured foam rest tailored of nylon velour. A great comfort accessory. Will fit any car. Wonderful with our seat recliner. Straps fitted with easy-attach, easy-remove hooks. Color: *light gray.* Specify year when ordering.



No. 750

\$14.95 each

ST. CHRISTOPHER EMBLEM

True European craftsmanship! Gold finish medallion with magnet back will hold firmly on the dash or any other metal surface.



No. 22

\$ 2.75 each

811 PROSPECT AVENUE

POLY PAD IMPORTS

CLEVELAND 15, OHIO

Accessories for the Volkswagen Owner

FOR COMFORT AND CONVENIENCE

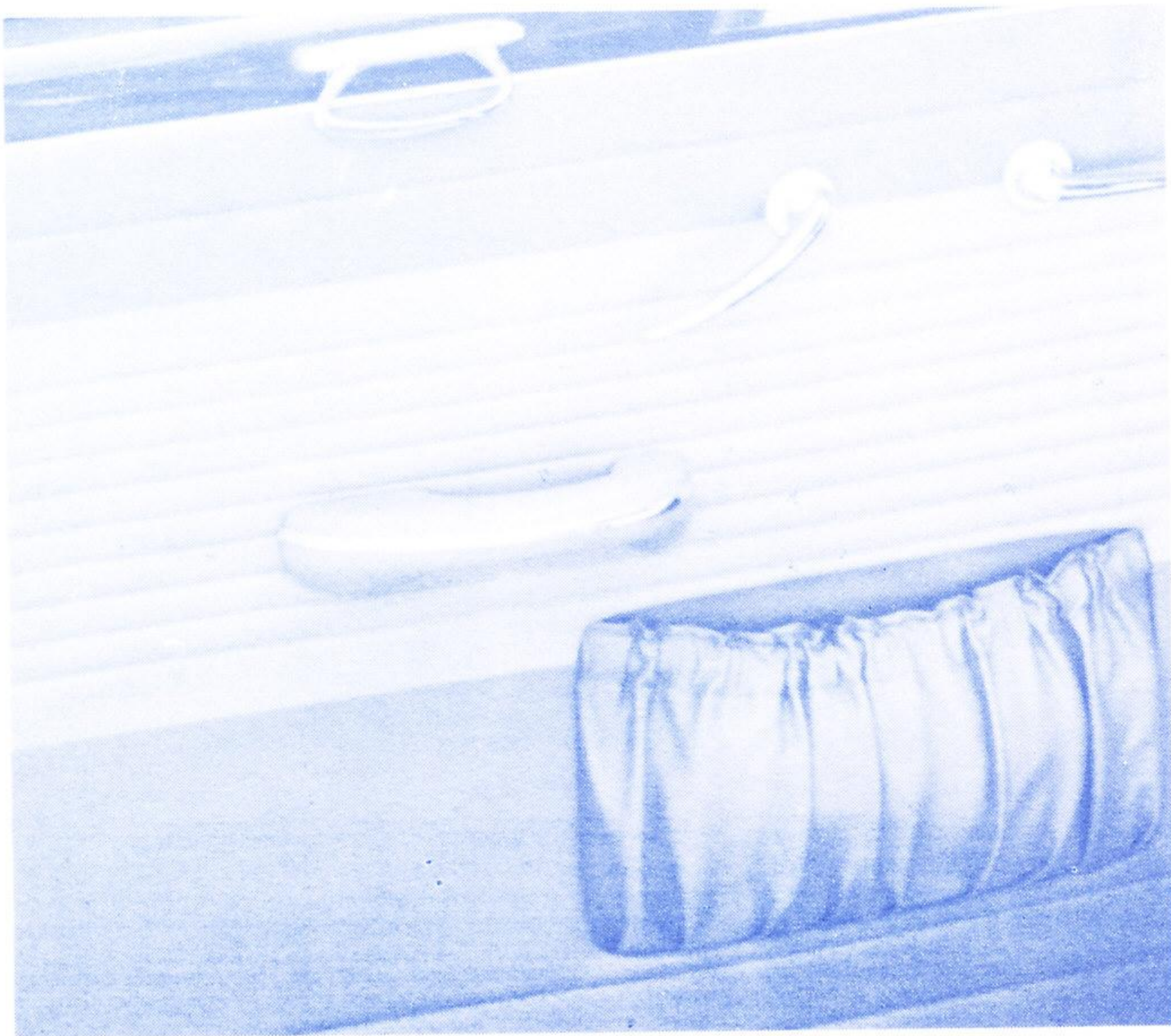

DRIVER'S ARM REST
... **Door Closer, too!**

The driver can now be more comfortable. Reduce driving fatigue. Use as a door closer, too. Easy to install with template supplied. Available in gray or tan. Will fit any car.

No. 412

\$ 3.95 each

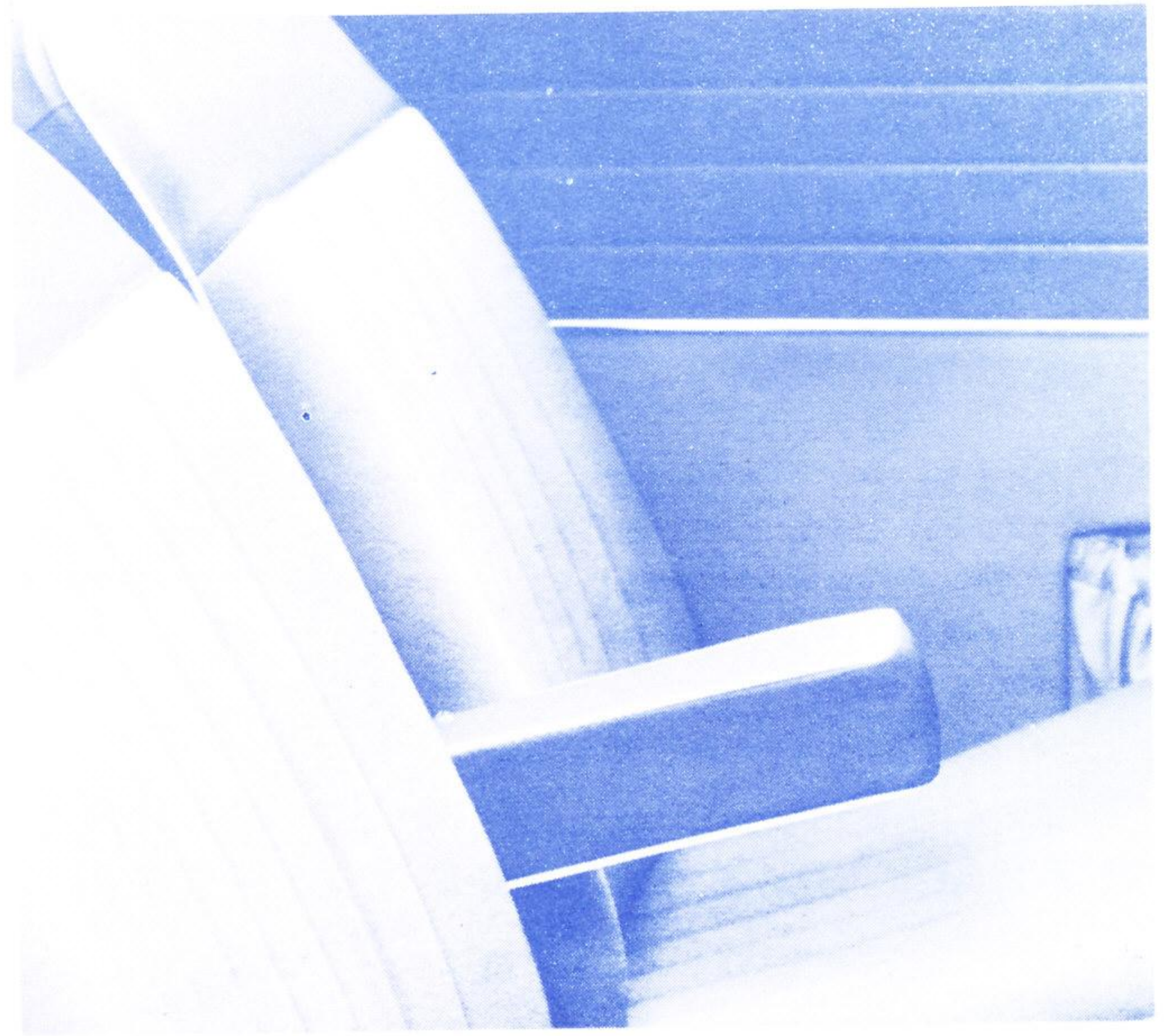

CENTER ARM REST

Put the fun back into long trips. Easy installation, no holes to drill. New model clamps on to the side of the seat and is completely adjustable for height. Arm rest hinges back when not in use. Available in tan and gray. Fits all Volkswagens from 1960 on.

No. 730

\$10.95 each



CLOTHES BAR

New, convenient model snaps in quickly without tools, out of the way in the corner. Won't block rear view. Notched along the top to keep hangers from sliding. Won't bend or break under heavy load. Large capacity. Fits all late model Volkswagens.

No. 1200

\$ 4.95 each

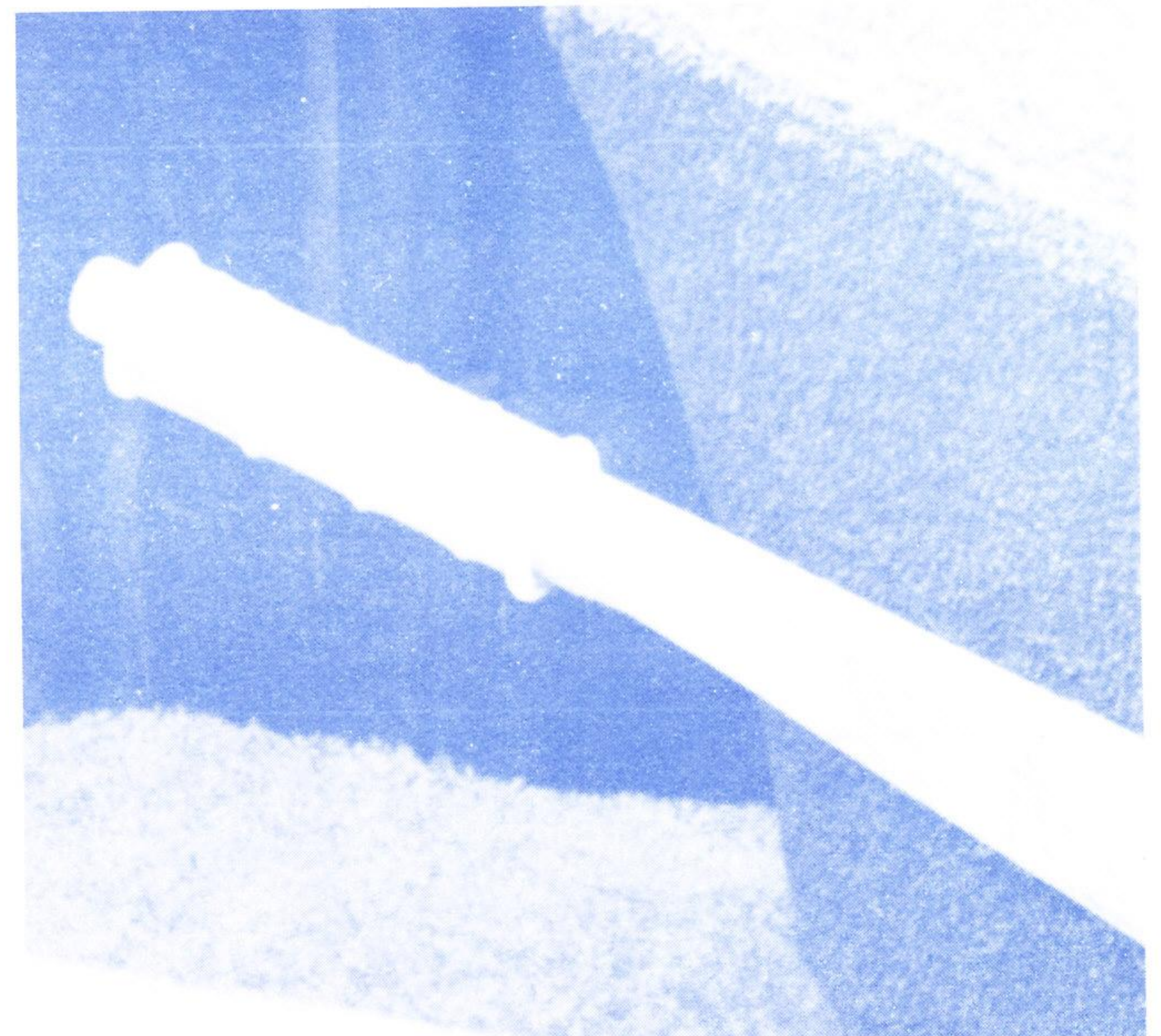

EMERGENCY BRAKE GRIP
... **for Safety**

For sure grip of the emergency brake handle. Handy plastic cover hides unsightly scratches, adds "dress" to the interior. For Volkswagens, all years.

No. 149

\$.98 each



TILT-BACK SEAT RECLINER

Enjoy the comfort of reclining seats! POLY PAD'S Seat Recliner installs in 20 minutes with no holes to drill! Reclining plates are 3/16" thick and satin cadmium plated. No small moving parts. The easiest and safest to operate; a flick of the wrist and back it goes, push it forward to resume normal position. Positive lock in all positions. Fits all years VW sedans, sunroofs and convertibles only.

No. 1040

\$ 6.95 per seat

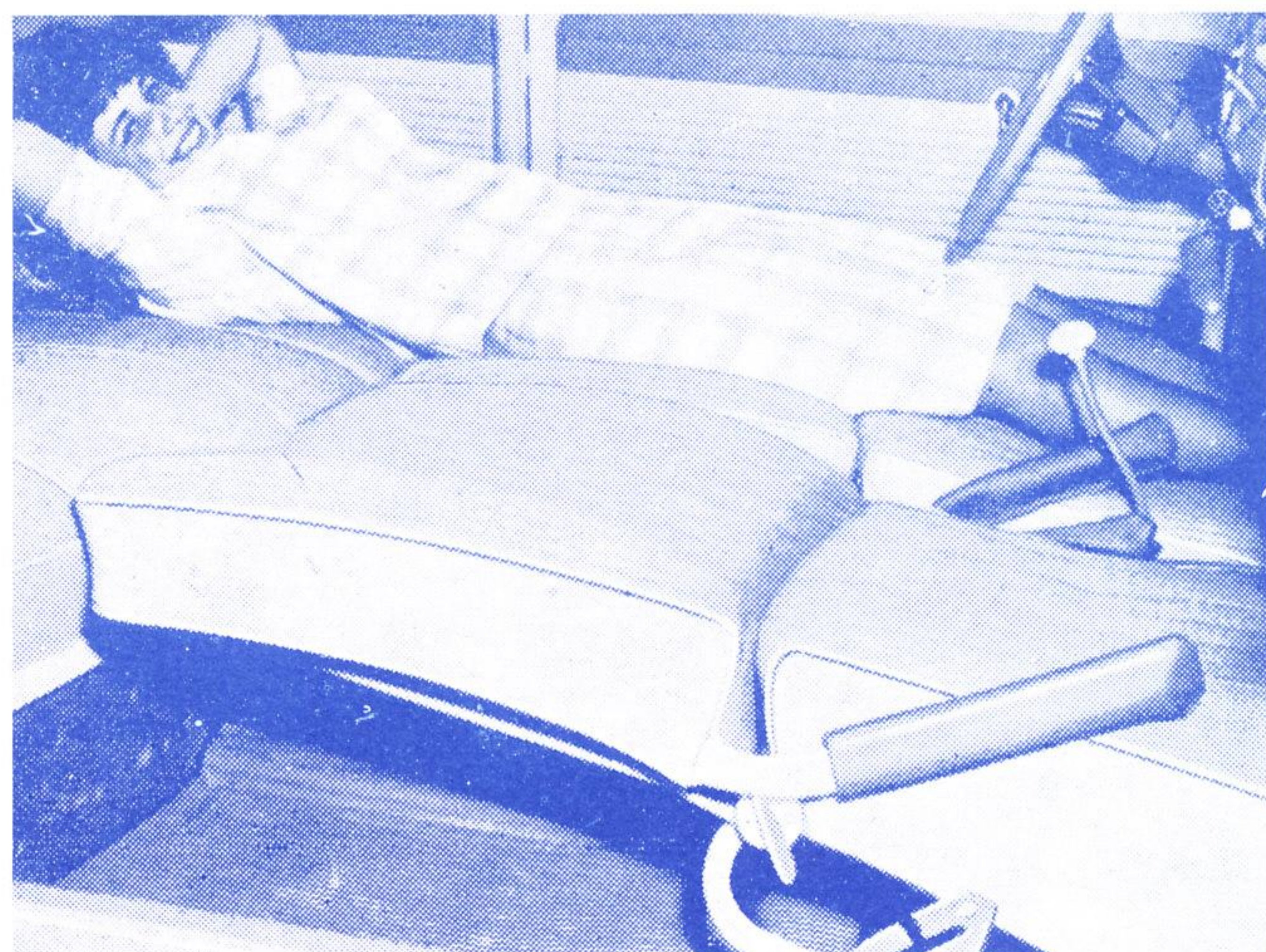

CAMPING BED CONVERSION KIT

All the necessary parts to convert your Volkswagen seat into the neatest berth you ever saw. Includes the POLY PAD Seat Recliner, too! Nothing to remove from the car; nothing extra to carry. Passenger seat can be used as a bed while the driver operates the car. Easy 5-minute conversion fits all years Volkswagen sedans, sunroofs and convertibles only.

No. 1050

\$11.95 per seat - complete kit

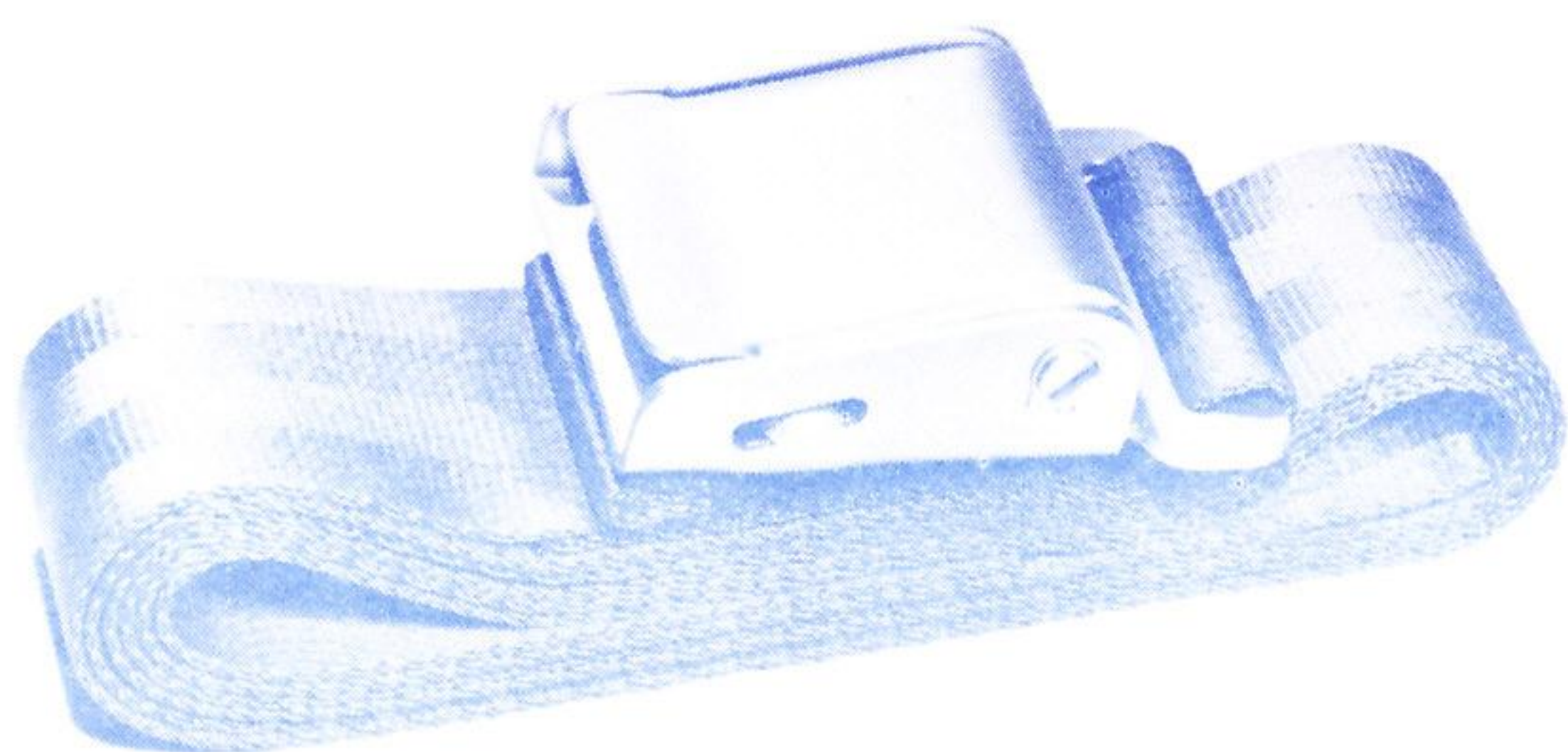

NYLON SEAT BELTS

100% all-nylon webbing. Equipped with fast action metal-to-metal buckle - holds firmly, yet releases instantly at the flick of a finger for safety. Designed and constructed to exceed all federal and S.A.E. specifications and proven in actual crash tests. Snap-hook type floor hardware for maximum security. Easily installed. Complete with hardware to fit all late model VW's and all other cars as well. Installation instructions included. Available in black, red, green and tan. Specify color choice and make and year of car.

No. 1020

\$ 6.95 each



SAFETY BELT - Combination Lap/Shoulder

Safest belt available! Quick-release metal-to-metal buckle has quick adjustment for passenger comfort. All parts are chrome-plated. These German belts are made to the most exacting standards and meet all International and National Standards. In neutral gray only for front seat installation. For 1965 sedans, sunroofs and convertibles only.

No. 1010

\$12.95 each

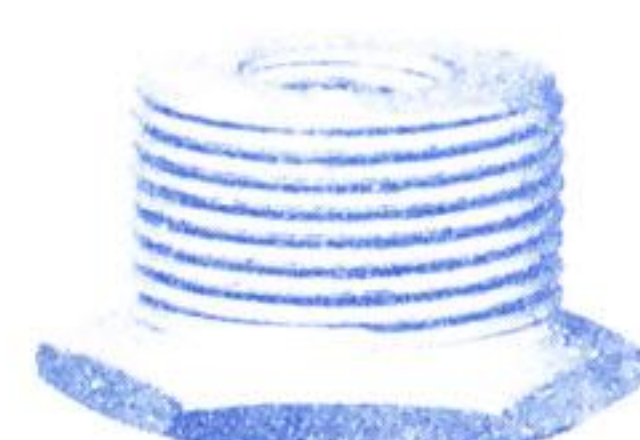

SEAT BELT ADAPTER

Converts standard American seat belt fittings to match metric fittings in all late model Volkswagens.

No. 705

\$.50 each

811 PROSPECT AVENUE

POLY PAD IMPORTS

CLEVELAND, OHIO 44115

Accessories for the Volkswagen Owner



EPOXY STEERING WHEEL

New beauty and safety for '61 and later Volkswagens. Custom German-made wheel looks like fine wood, but is made of indestructible non-splintering epoxy. Won't show dents or scratches. Chrome spokes and horn ring. Handsome horn button. Works with existing VW horn wiring. Easy to install, complete kit and instructions supplied.

No. 65 **\$39.95** each

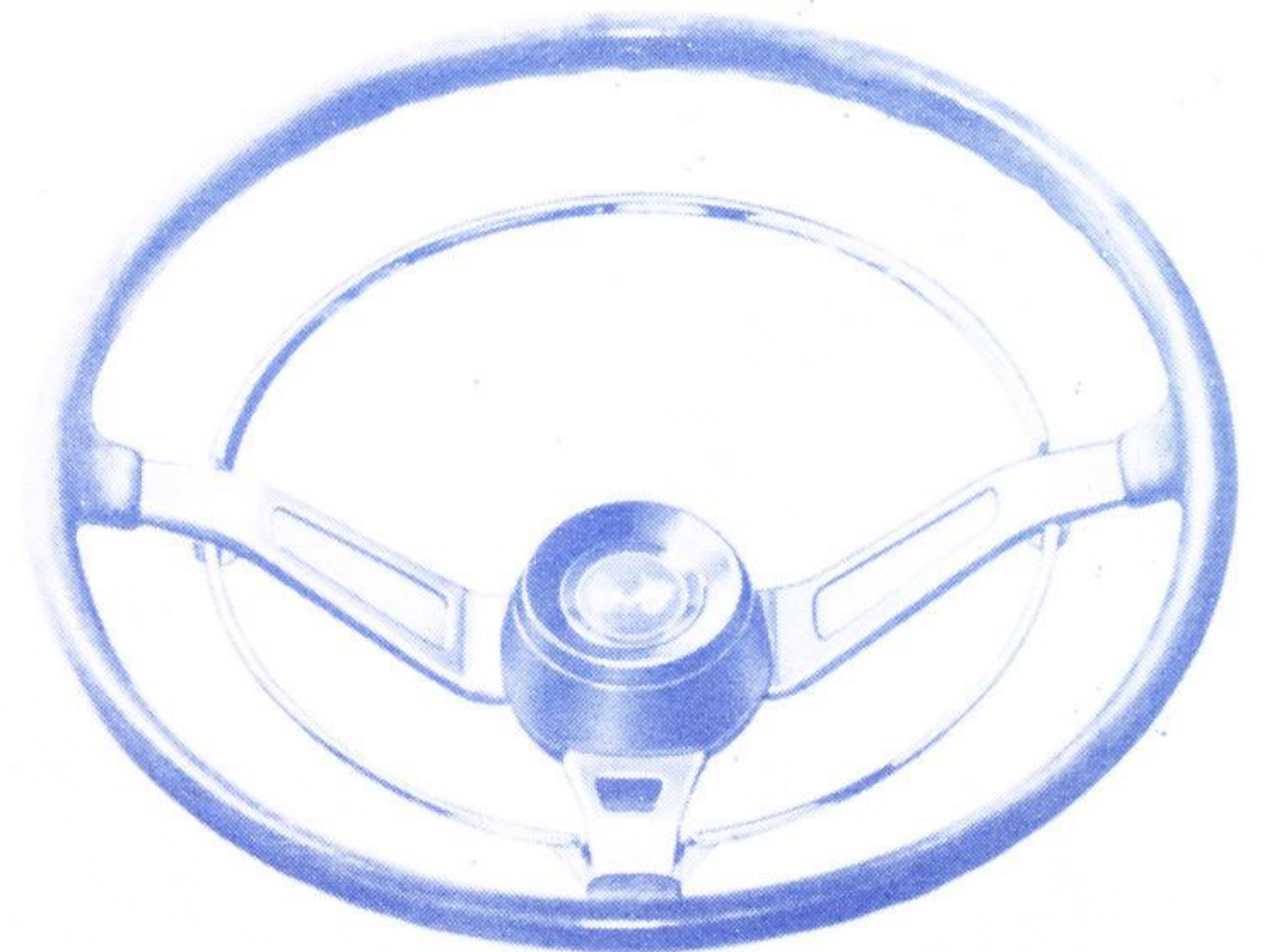

STEERING WHEEL GLOVE
— Luxurious Genuine Leather



For a safe, comfortable grip in all weather! Soft, pliable leather cover laces firmly to any 15½" steering wheel to provide a sure, non-slip hold. Backed with plastic foam — won't twist or slide — reduces vibration and driver fatigue. Does away with driving gloves. Pre-punched lacing holes for easy installation. Available in black, white and tan. Fits all Volkswagens.

No. 1080 **\$ 7.95** each

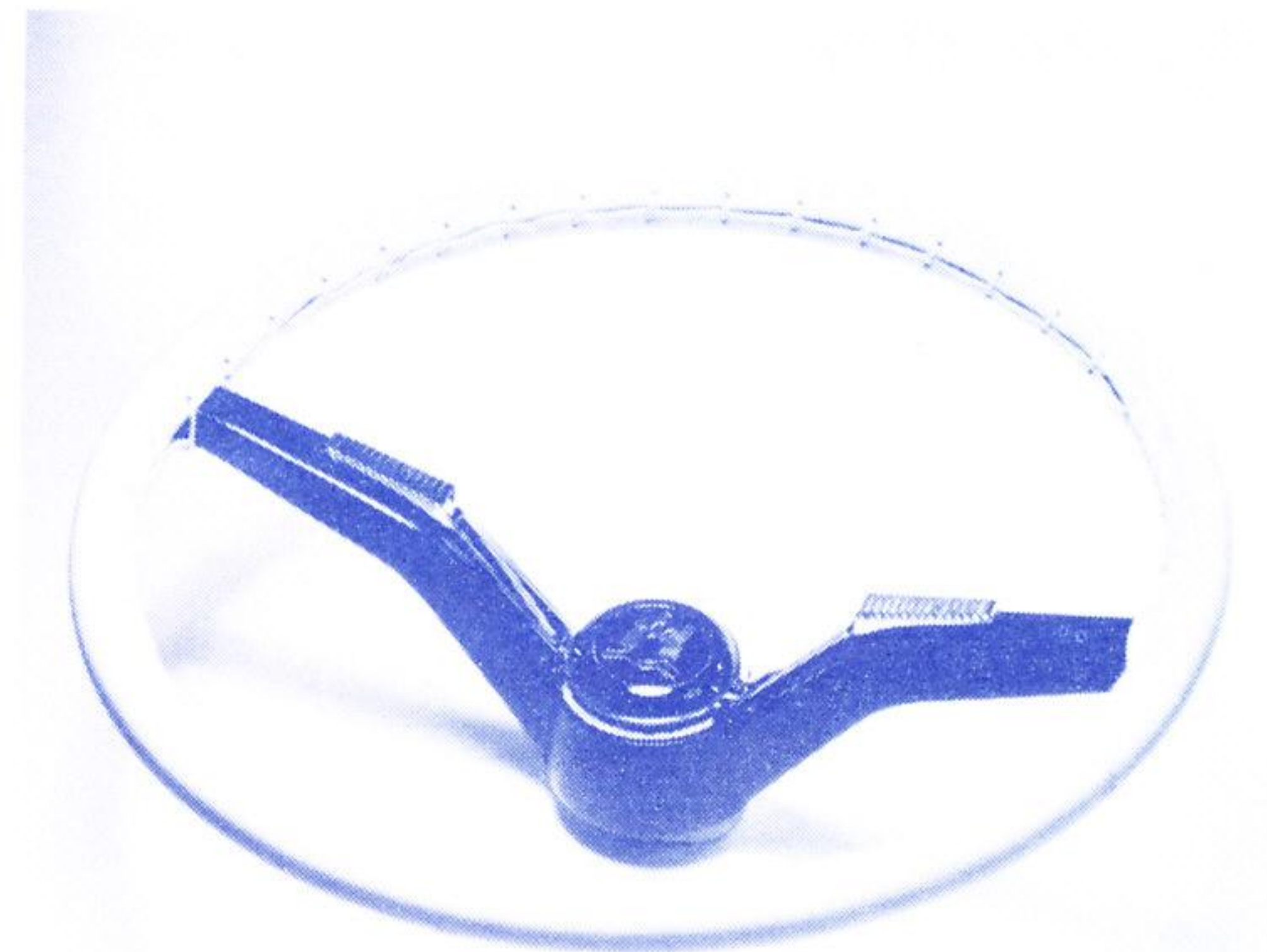

ACCELERATOR PEDAL COVER

Prevents wintertime ice freeze-up on accelerator pedal. Prevents dirt from clogging up accelerator linkage. Protects tunnel from excessive wear, floor mat from heel wear. Built-in heel rest adds to driving comfort and protects ladies' heels. Easily attached; no alterations, no tools needed. Fits all Volkswagens, Ghia's, Volkswagen 1500's.

No. 660 **\$ 2.75** each

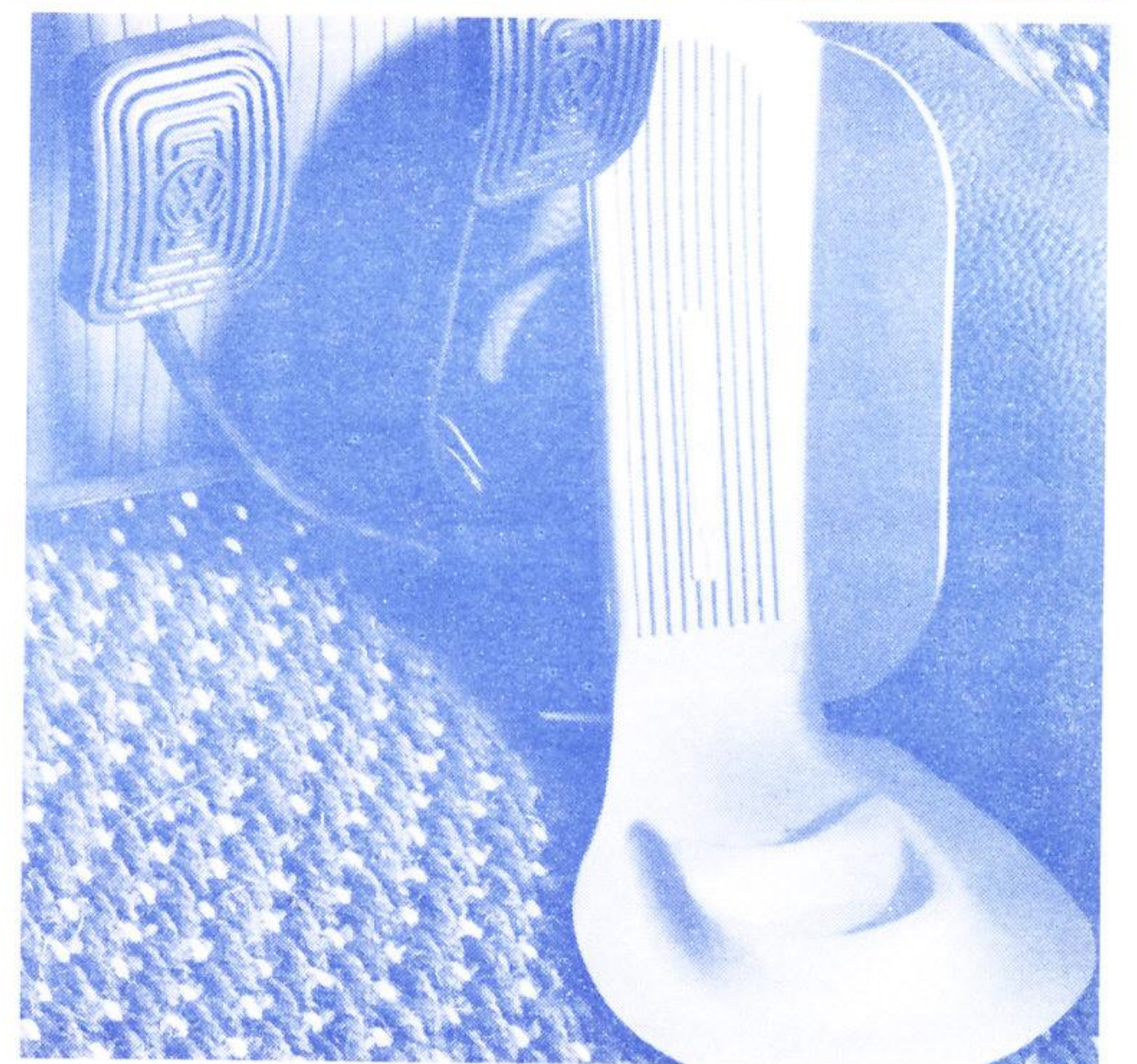

SIGNAL LEVER COVER

A practical bit of customizing. Heavy gauge chrome-plated cover adds support needed to prevent breaking of the turn signal lever. Extra length acts as an extension, too. Locks in place with tabs. Fits all Volkswagens.

No. 643 **\$ 3.95** each

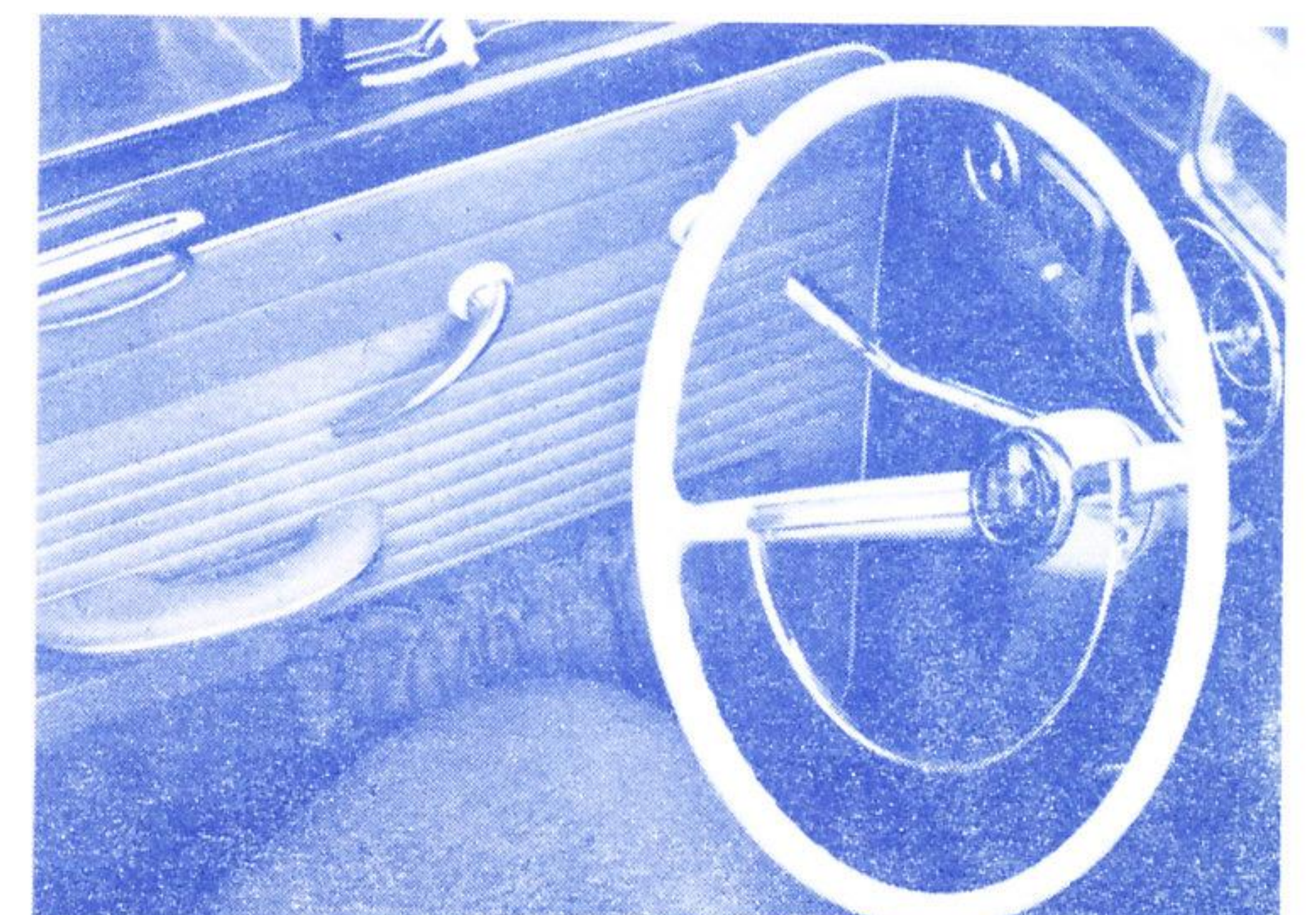

DOOR PILLAR GUARDS

The perfect way to protect the finish around your door pillar. Eliminates scuffed paint and torn upholstery. Made in Switzerland from heavy aluminum in hammered finish. No alteration necessary to install. Mounts in inspection holes with special rubber fasteners furnished. Specify year and model VW when ordering.

No. 320

\$ 3.95 per pair

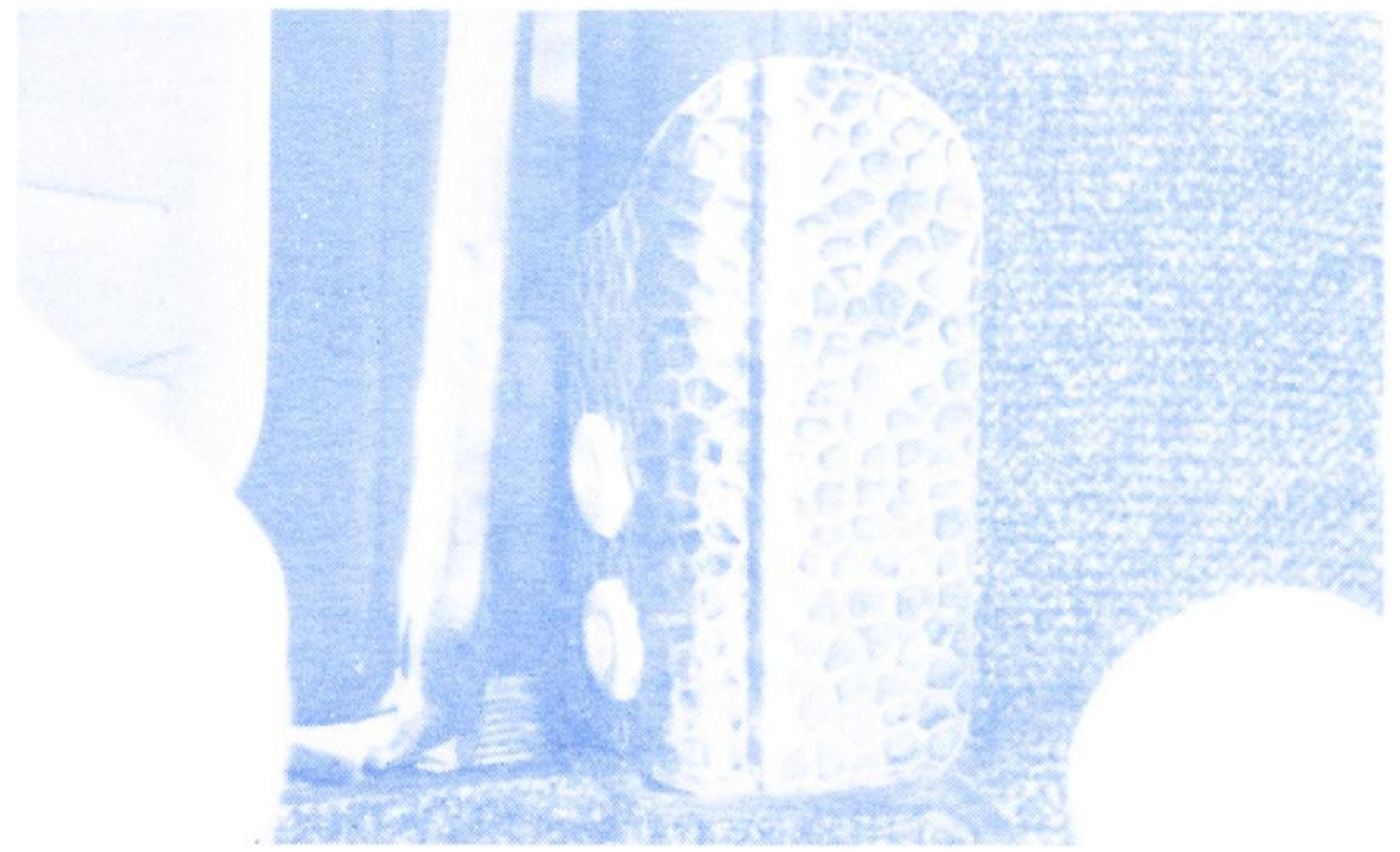

DOOR PULLS

For extra convenience and surer door closing. Newly designed chrome plated door pull handles eliminate strain on other door hardware. Pulls are spring-loaded and ride flat against the door when not in use. Complete with all fittings for all Volkswagens; any year.

No. 983

\$ 4.95 per pair



VENT-WINDOW LOCKS

Positively prevents anyone from forcing open your vent window. Installs in seconds with no alteration. For all Volkswagens, any year.

No. 21

\$ 4.95 per pair

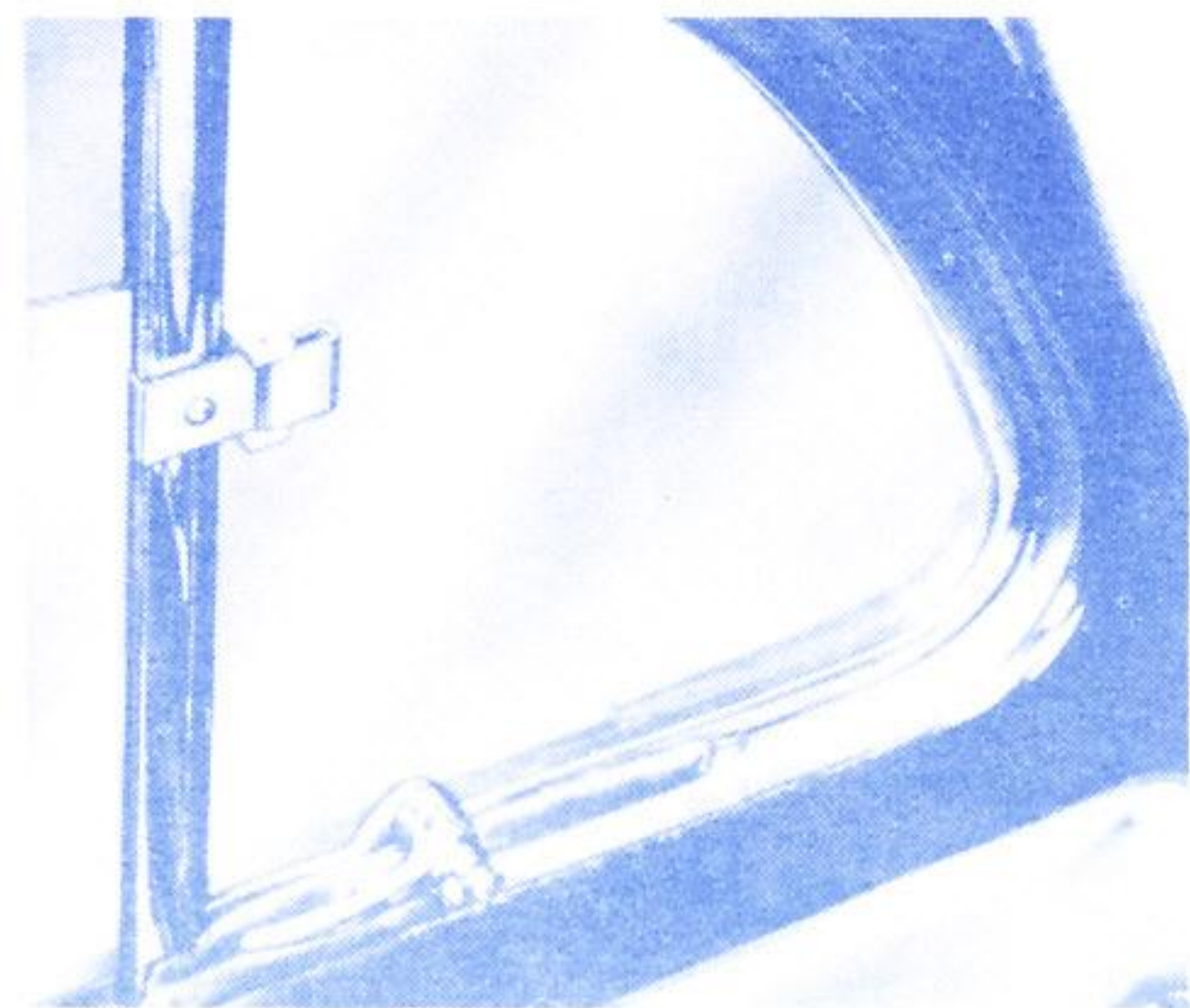

GLOVE COMPARTMENT DIVIDER



Makes everything easy to find. Organize your glove compartment with this 6-section divider. Eliminates endless rummaging. For all Volkswagens, any year.

No. 565

\$ 2.95 each



GLOVE-BOX PULL

Highly polished chrome handle, perfect for sticking and hard to open glove box doors. Installs easily by drilling two holes. For all Volkswagens, any year.

No. 18

\$ 1.00 each

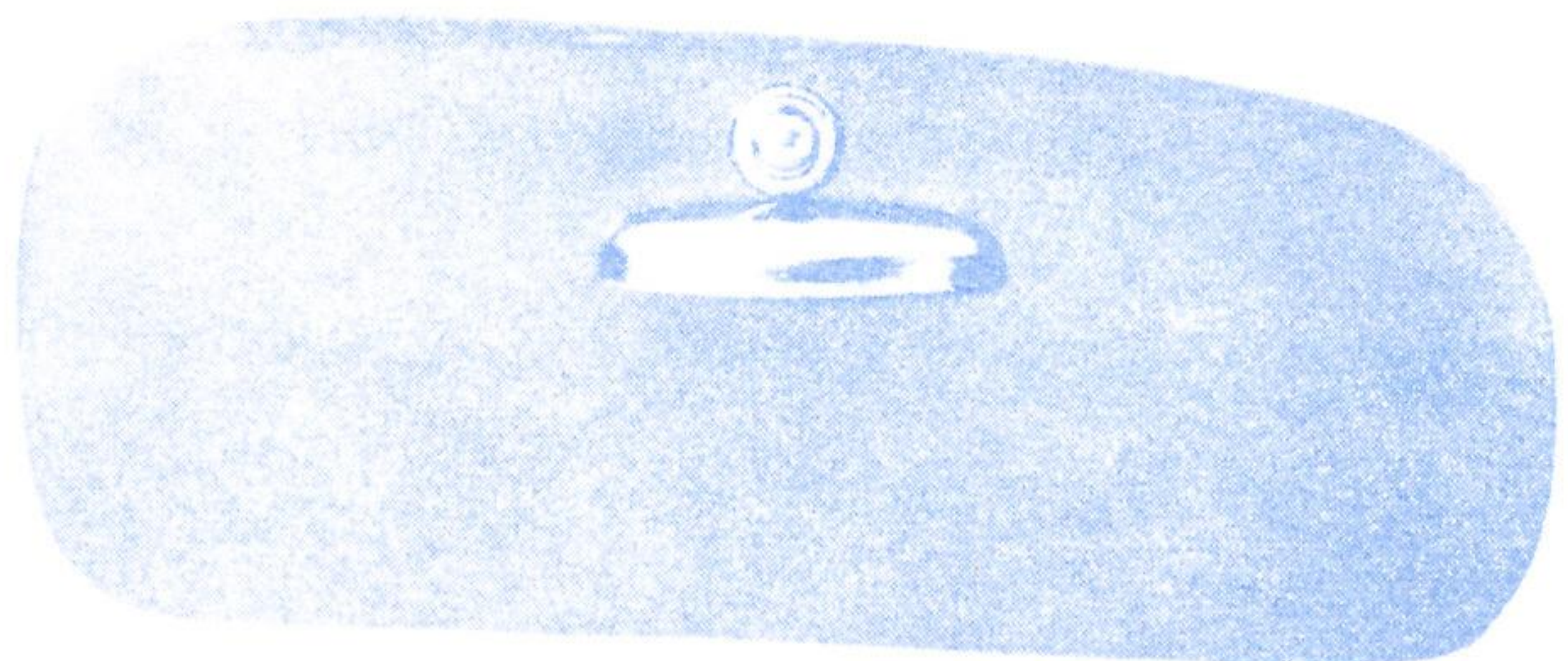

811 PROSPECT AVENUE

POLY PAD IMPORTS

CLEVELAND 15, OHIO

Accessories for the Volkswagen Owner

FOR EXTRA STORAGE SPACE

BAMBUS PARCEL SHELF

Used by VW owners all over the world. Three divisions prevent articles from sliding on the shelf. Does not interfere with driving or leg room. Easily installed or removed without alteration or damage to the car. Finished in beautiful ivory to harmonize with all interiors. Fine, hand-made craftsmanship. For the following European cars:

No. BA 1	VW 1200 Sedan & Sunroof	\$ 13.95 each
No. BA 2	VW 1200 Convertible	\$ 13.95 each
No. BA 4	VW 1500 Sedan	\$ 15.95 each
No. BA 5	VW 1500 Ghia	\$ 15.95 each
No. BA 6	Renault Dauphine Gordini	\$ 14.95 each
No. BA 7	Mercedes-Benz 190 - 200	\$ 13.95 each



DRIVER'S SHELF

Convenient shelf for gloves and other articles. Installs easily on steering column and side panel with support brackets supplied. NO holes to drill! Attractive neutral gray finish. For all VW sedans and sunroofs.

No. 20 \$ 6.95 each



QUILTED REAR SHELF

Creates extra concealed storage space; keeps packages from prying eyes. Hinged lid permits easy loading from the top; tilt the seat forward for larger articles. Padded and insulated; helps to reduce motor noise. Covered in light gray tufted vinyl with chrome nail heads. Easy installation, no holes to drill. Secure, rattle-proof mounting. German-made. Fits all VW sedans and sunroofs.

No. 429 \$17.95 each

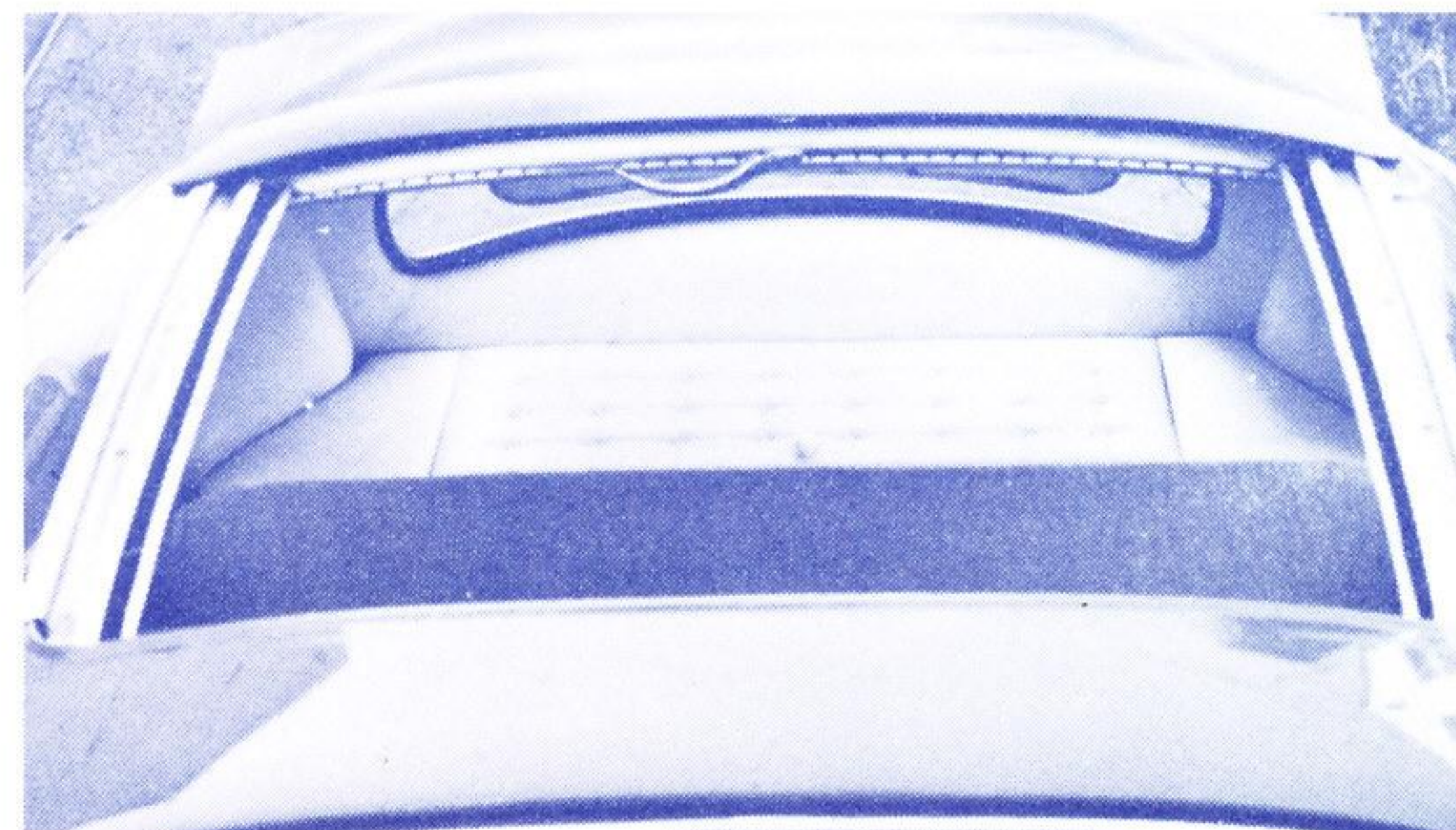

REAR SHELF

Unique shelf made in three sections permits storage of any size article. Attractive in light gray vinyl, unit installs easily to provide extra concealed storage space. Sturdy construction.

No. 845 \$11.75 each

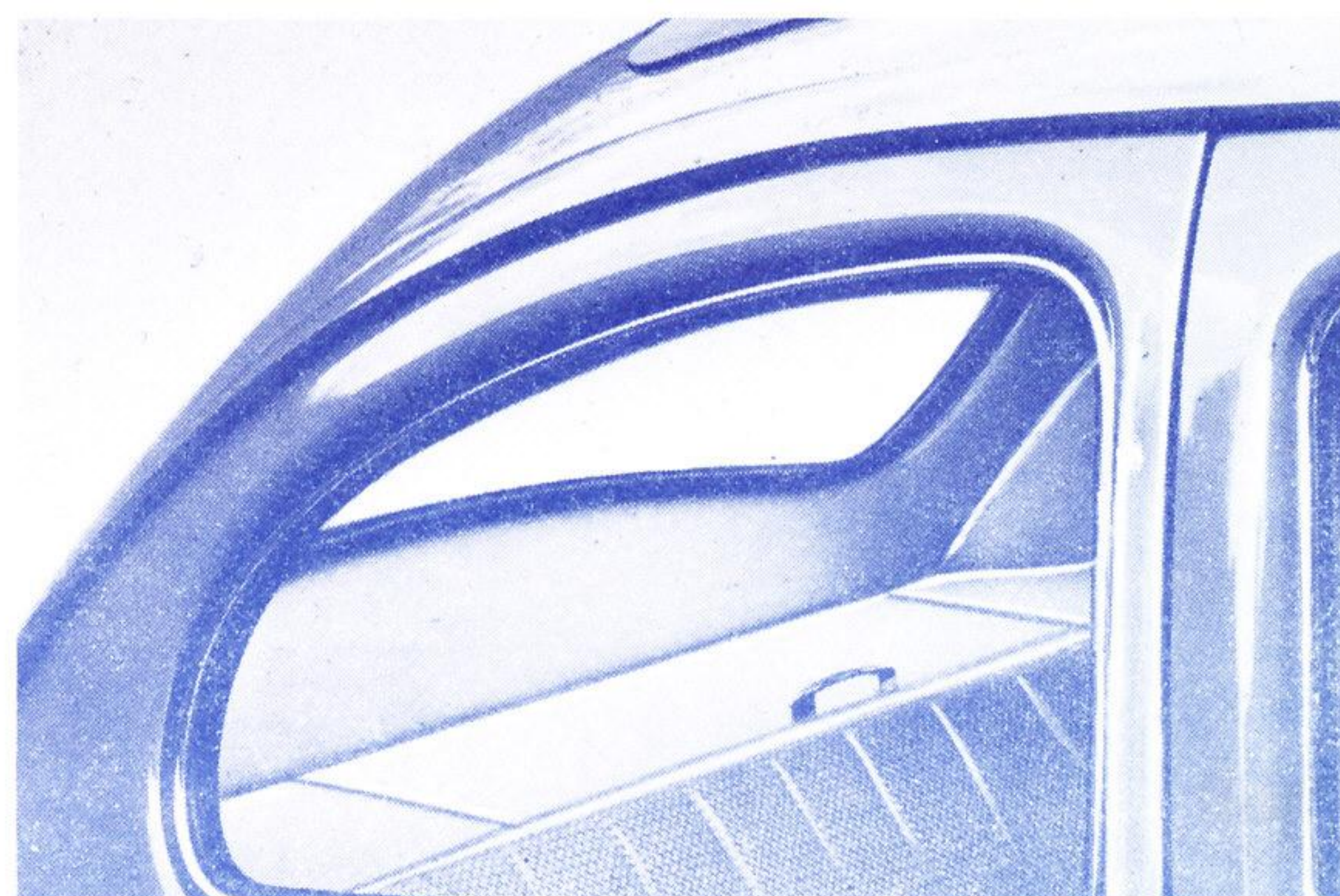

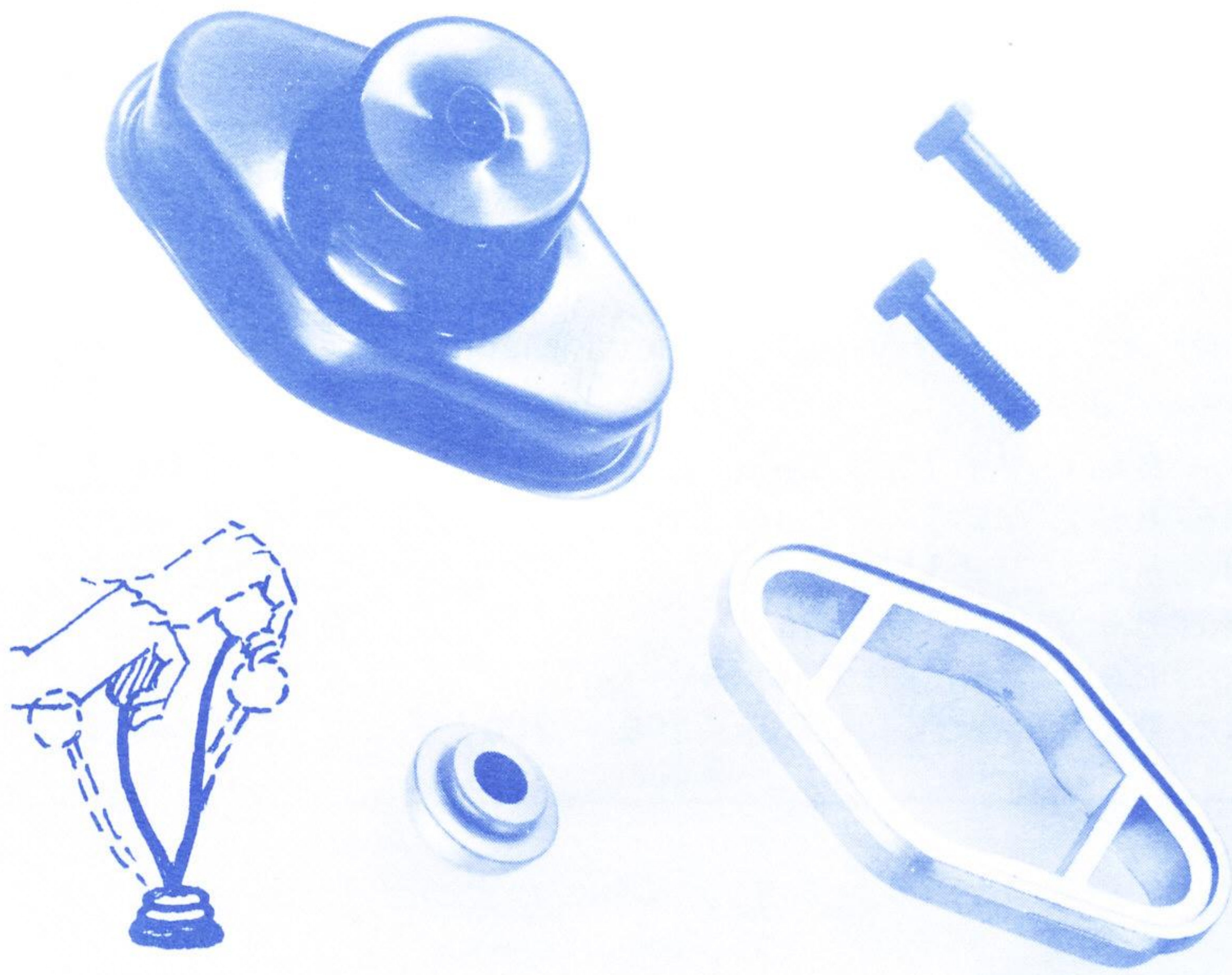

"QUICKSHIFT" CONVERSION KIT

● Makes shifting easier in everyday driving ● Makes the vital difference in competition

New Poly Pad *QUICKSHIFT* . . . for any VW car or truck. Modifies shift linkage mechanism to reduce by 40% the distance driver's arm must travel when shifting. Valuable seconds mean the difference between winning and losing in competition driving. In heavy traffic or everyday driving *QUICKSHIFT* greatly reduces arm fatigue. This truly easy-to-install unit out-dates anything now on the market. Improved, machined and cast parts are plated for extra smoothness and durability. Fits any VW car or transporter.

No. 1500
No. 1501

QUICKSHIFT
Molded black vinyl boot for *QUICKSHIFT*

\$ 4.95 each
\$ 2.75 each



GEAR-SHIFT EXTENSION

Our own idea for easy shifting to 3rd gear, comfortable driving. Ideal in traffic, or competition driving. Nickel plated, complete with lock nut. Fits all VW's and transporters. Specify year and model when ordering.

No. 1421 (Transporter) \$ 1.50 ea.
No. 1421-S (Sedan) 1.50 ea.

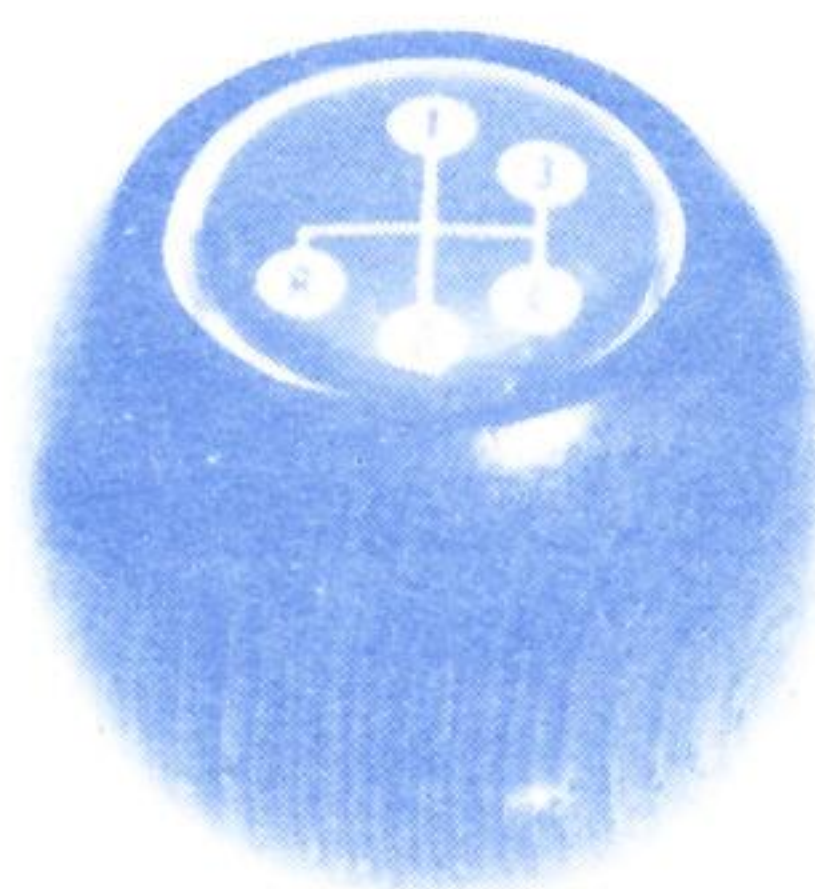

ROSEWOOD SHIFT KNOB

Handsome, Rosewood Gear Shift Knob adds a distinctive touch to the interior of any Volkswagen. The shift pattern (on knob) alerts parking lot attendants to the shift procedure on your car. Will fit all sedans, sunroofs, convertibles and Ghia's from 1961 on.

No. 369 \$ 3.95 each

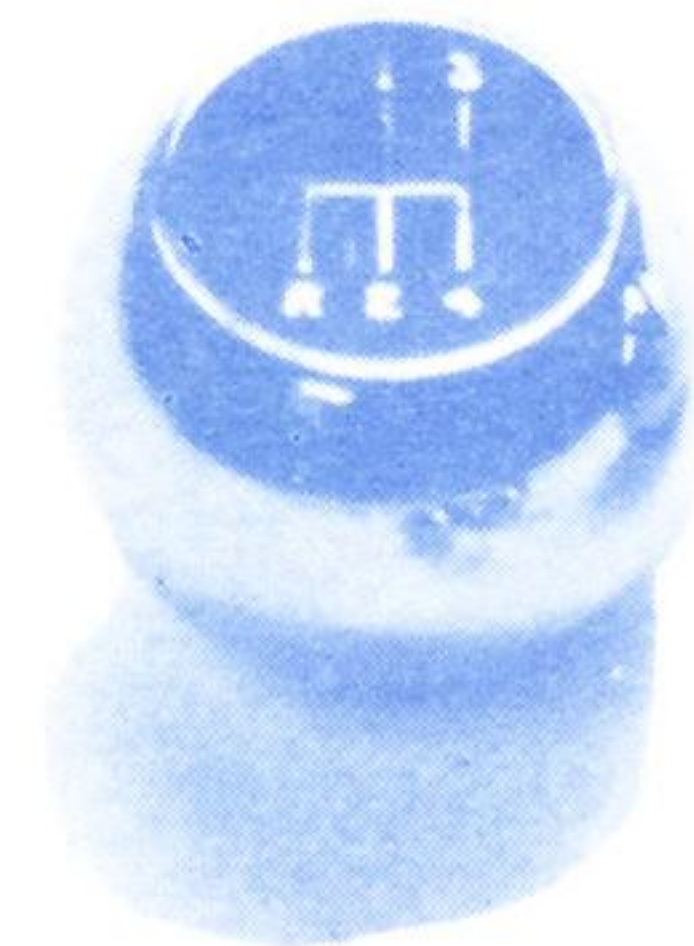

CHROME SHIFT KNOB

Two inch round, heavy chrome plated gear shift knob will add "beef" to the shift lever, will make it easier for you to get in and out of gears. Permanent cast shift pattern insert furnished. Fits all Volkswagens and transporters. Specify year when ordering.

No. 368 \$ 3.95 each

311 PROSPECT AVENUE

POLY PAD IMPORTS

CLEVELAND 15, OHIO

Accessories for the Volkswagen Owner

WINTER AND SUMMER COMFORT

DEFROSTER SHIELDS

Direct a *concentrated flow of warm air* over the entire windshield. Eliminates misting and frosting. Keeps defroster air from blowing in your face. Will hold securely in vent slots. No drilling or damage to windshield frame.

No. 393

\$ 1.95 per pair



NEW PERFECTION "INSTANT" FUEL-FIRED HEATER

A VW *full of heat in 12 seconds!* PERFECTION heater by Hupp supplies fast heat at low cost. Thermostat controlled, keeps heat at desired level and fuel consumption at a minimum. Wholly independent system is extremely compact, requires very small space in front storage compartment. Brings in heated *fresh air*. Unit proven safe and efficient in thousands of military vehicles. Puts out 15,000 BTU Hour. All hardware for uncomplicated installation, full instructions supplied with each heater.

- | | | |
|-------------|--|--------------|
| No. IH 1200 | Complete, for all year VW sedans, convertibles, 1500's 1961-1965 | \$145.65 ea. |
| No. IH 1201 | Complete for solid-seat transporters, 1961-1965 | \$148.00 ea. |
| No. IH 1202 | Complete for split-seat transporters, 1961-1965 | \$158.00 ea. |
| No. IH 1203 | Complete for K. Ghia, 1961-1965 | \$153.00 ea. |
- Specify model and year when ordering.

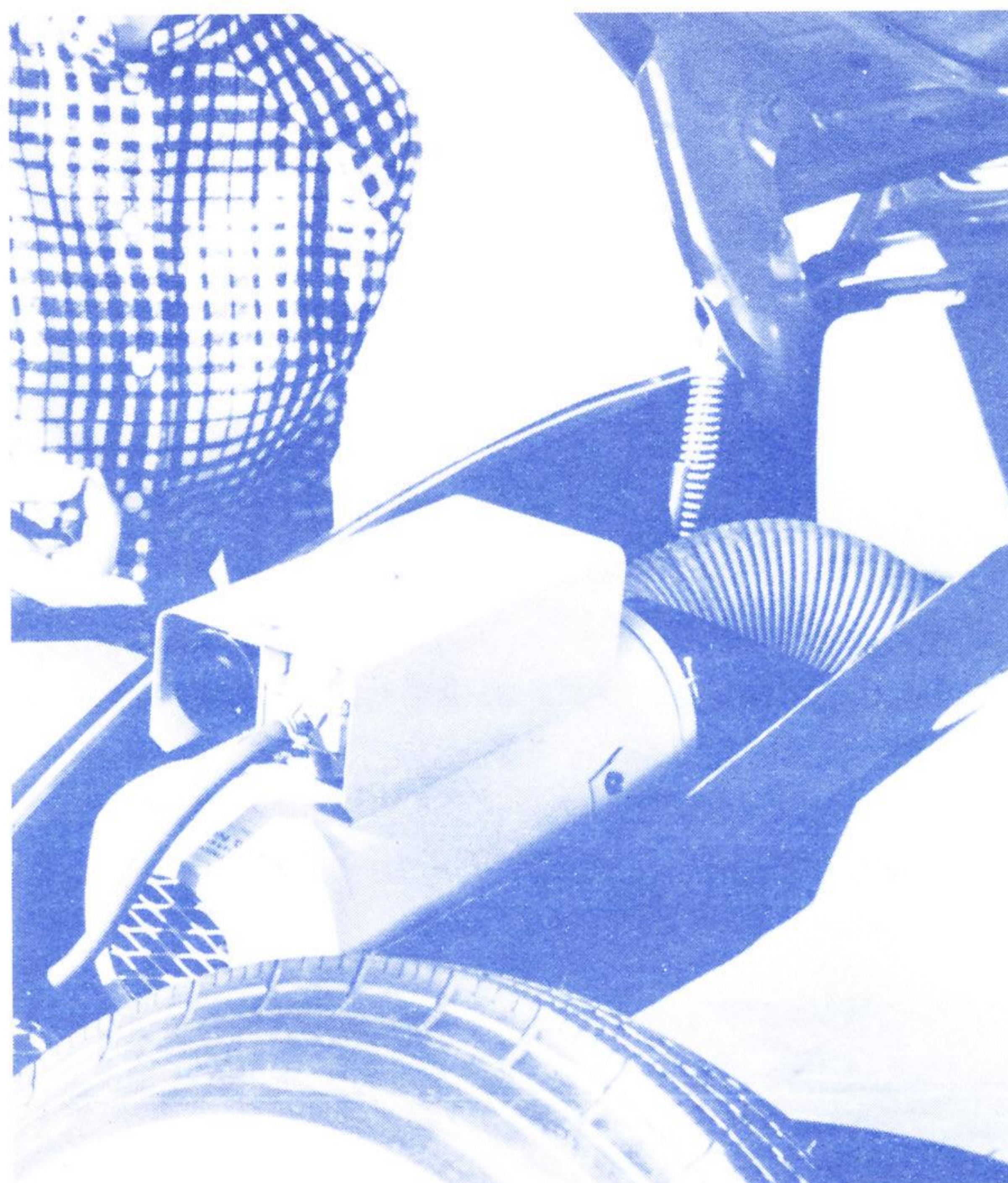

HEATER BLOWER KITS

For more *circulation of heat* in your Volkswagen. Keeps the driver and passengers warm in the coldest weather. Easily installed under the rear seat. Complete with all necessary parts and illustrated installation instructions.

- | | |
|------------------------|--------------|
| No. 161 Sedans & Ghias | \$29.95 each |
| No. 162 Transporters | \$44.95 each |



ARTIC-KAR AIR CONDITIONER . . . compact, economical under-dash unit for VW's

Small, snug-fitting air conditioner for Volkswagens. The new improved *COMPACT* is only 11³/₄" wide, 6" high and 11" deep. Squirrel cage type blower with larger evaporator coil system provides an amazing 12,000 cubic feet hour of cool, refreshing air — 6 changes of air per minute. Cool air is directed by chrome, rotating ball-type louvers. Finger-tip control of the thermostat and variable speed air delivery. The *COMPACT* takes up none of the front luggage space. Available for all years and models of Volkswagens, sedans, convertibles and Ghias. Specify same when ordering.

V139W

\$299.00 complete

Models available for all other foreign and domestic cars. Write for quotations.

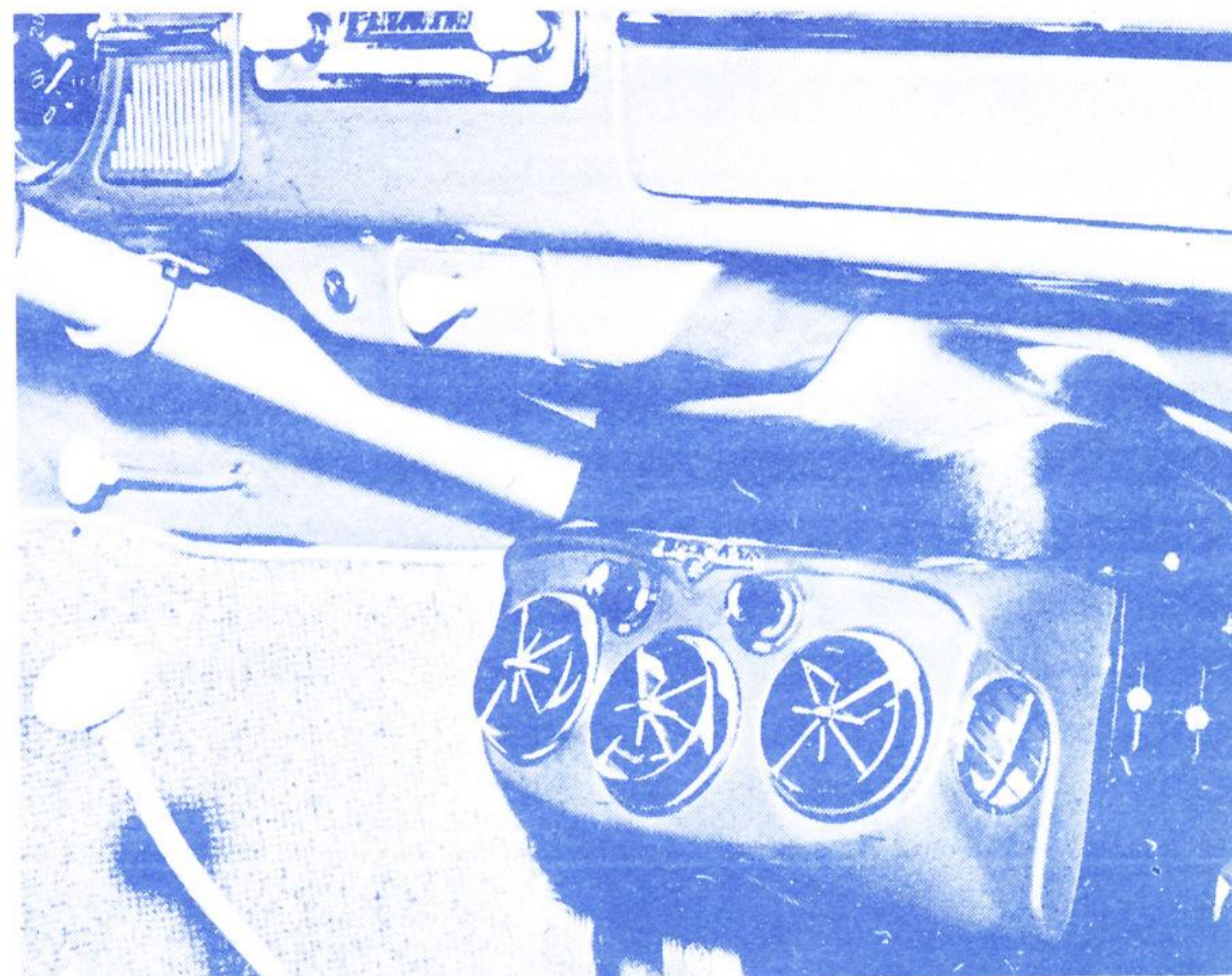

MIRRORS..MIRRORS..MIRRORS

NON-GLARE MIRROR

Anti-Glare rear view mirror with flip control for day or night. Perfect replacement for all sedans or sunroofs. Chrome plated. A must for safe driving at night.

No. 981 For models through '64 \$ 8.25 each
No. 981-A For '65 models \$ 8.95 each

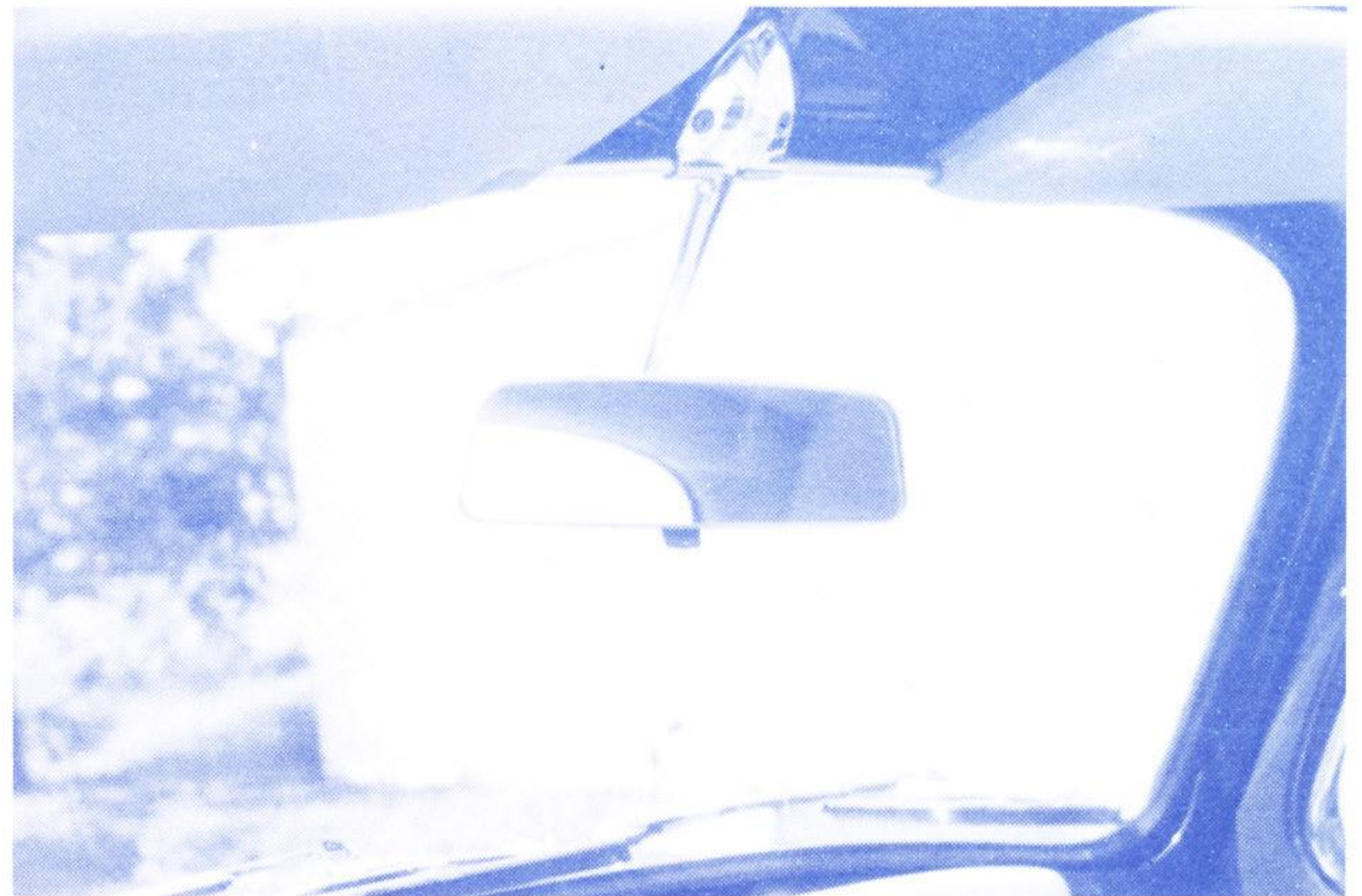

ANTI-GLARE SHIELD

Clip-on, polaroid shield for economical night time driving safety. Flips up or down for day or night. Specially designed for the Volkswagen. State year when ordering.

No. 891 \$ 1.95 each



"Primp-up" MIRROR

For the ladies! Quick-stick mirror installs on sun visor in a jiffy; simply remove paper backing and press on to the sun visor. Measures 3½" by 4½"; made with bevelled edges and distortion-free glass.

No. 34 \$ 1.00 each



NON-GLARE MIRROR FOR TRANSPORTERS

Bothered by bright lights behind you? Install this chrome 8" prismatic day-night rear view mirror. Easy two hole installation. Finest quality - rattle proof construction. Fits all transporters.

No. 193 \$ 6.95 each

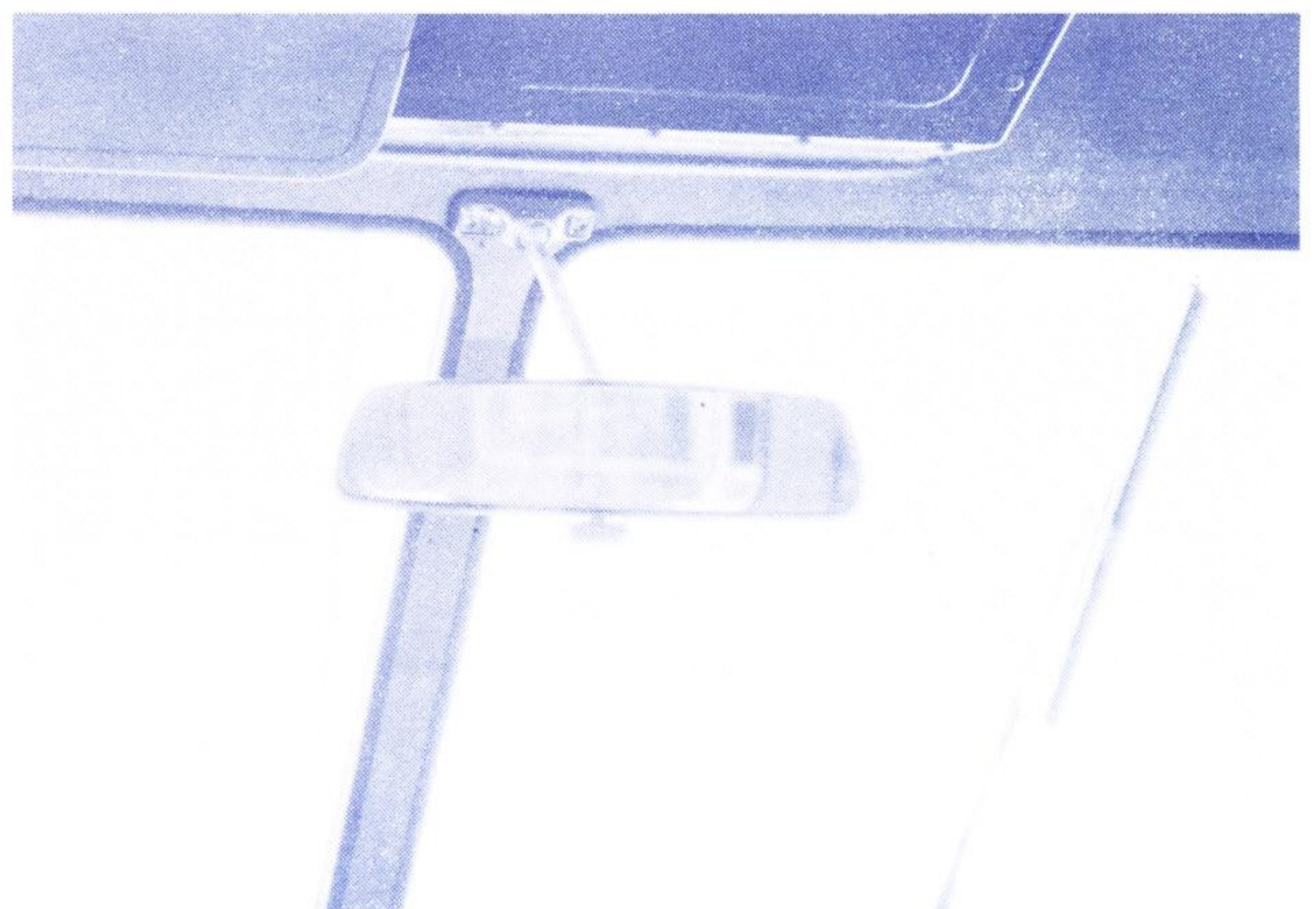

811 PROSPECT AVENUE

POLY PAD IMPORTS

CLEVELAND, OHIO 44115

Accessories for the Volkswagen Owner

SIDE-VIEW MIRRORS



**HINGE PIN . . .
SMART GERMAN DESIGN**

Easiest installation of all, it fits in the hinge pin! Locks in place and adjusts in moments! Smart German design, with replaceable glass, either flat or convex. Perfect styling for all VW's. Specify left or right side, flat or convex glass, when ordering.

No. 711 **\$ 4.75** each
Hinge Pin for right side **.25** each
Replacement Glass **.50** each



**NON-GLARE, HINGE PIN
. . . For either side**

Quality American-made mirror with non-glare 4½" glass. Mirror is fully adjustable and locks tight in all positions. Fits left or right side by reversing mirror head. Complete and ready for quick hinge pin installation. Extra heavy chrome plating on brass.

No. 305 **\$ 4.50** each

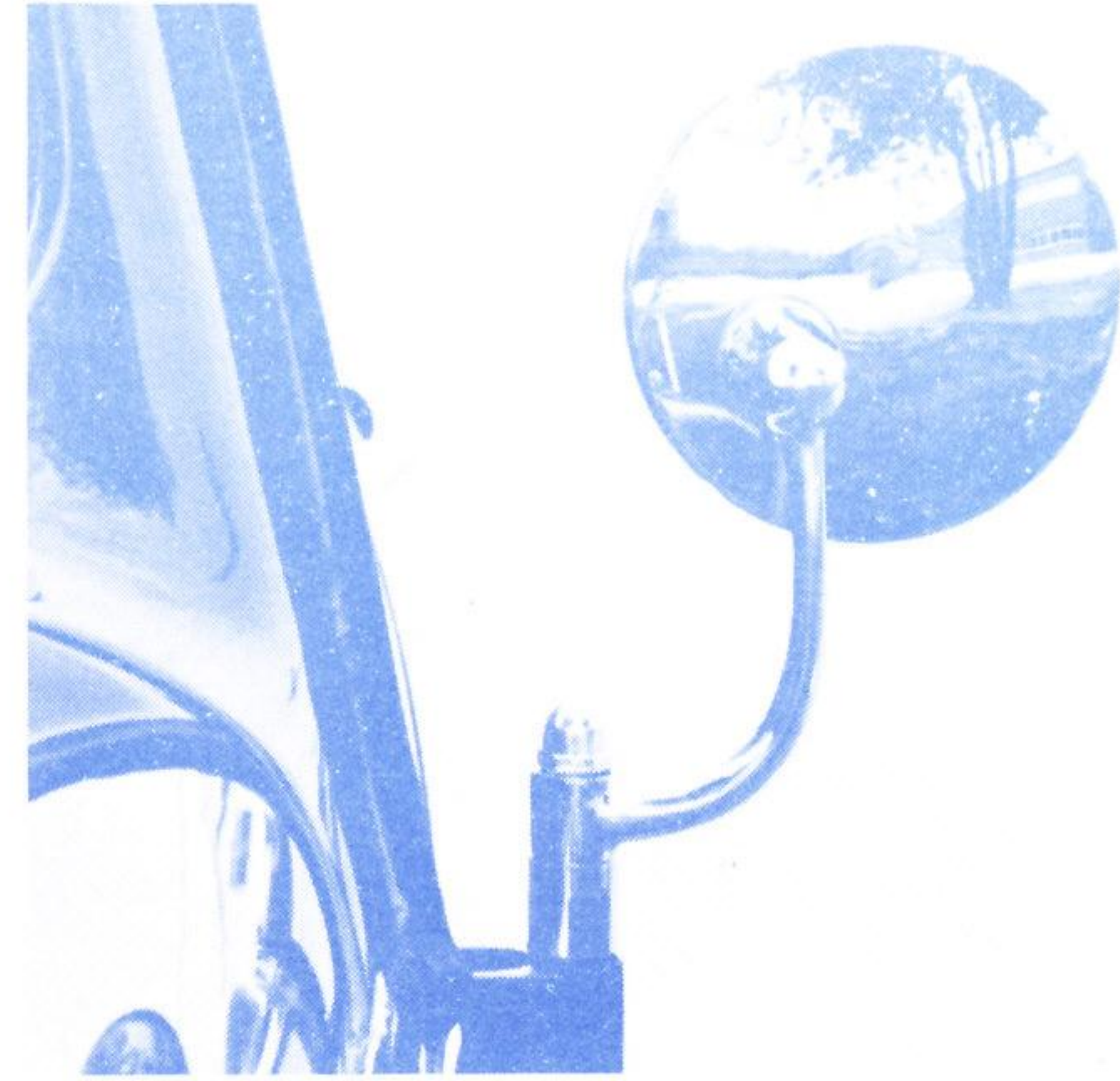

**NON-GLARE, HINGE PIN
. . . Left side only**

A very special value in American-made mirrors. Finely crafted, chrome plated mirror has 3¾" round tinted glass. Simply screw into hinge pin on left side. Fits all models from 1958 on. For left side only.

No. 311 **\$ 2.95** each

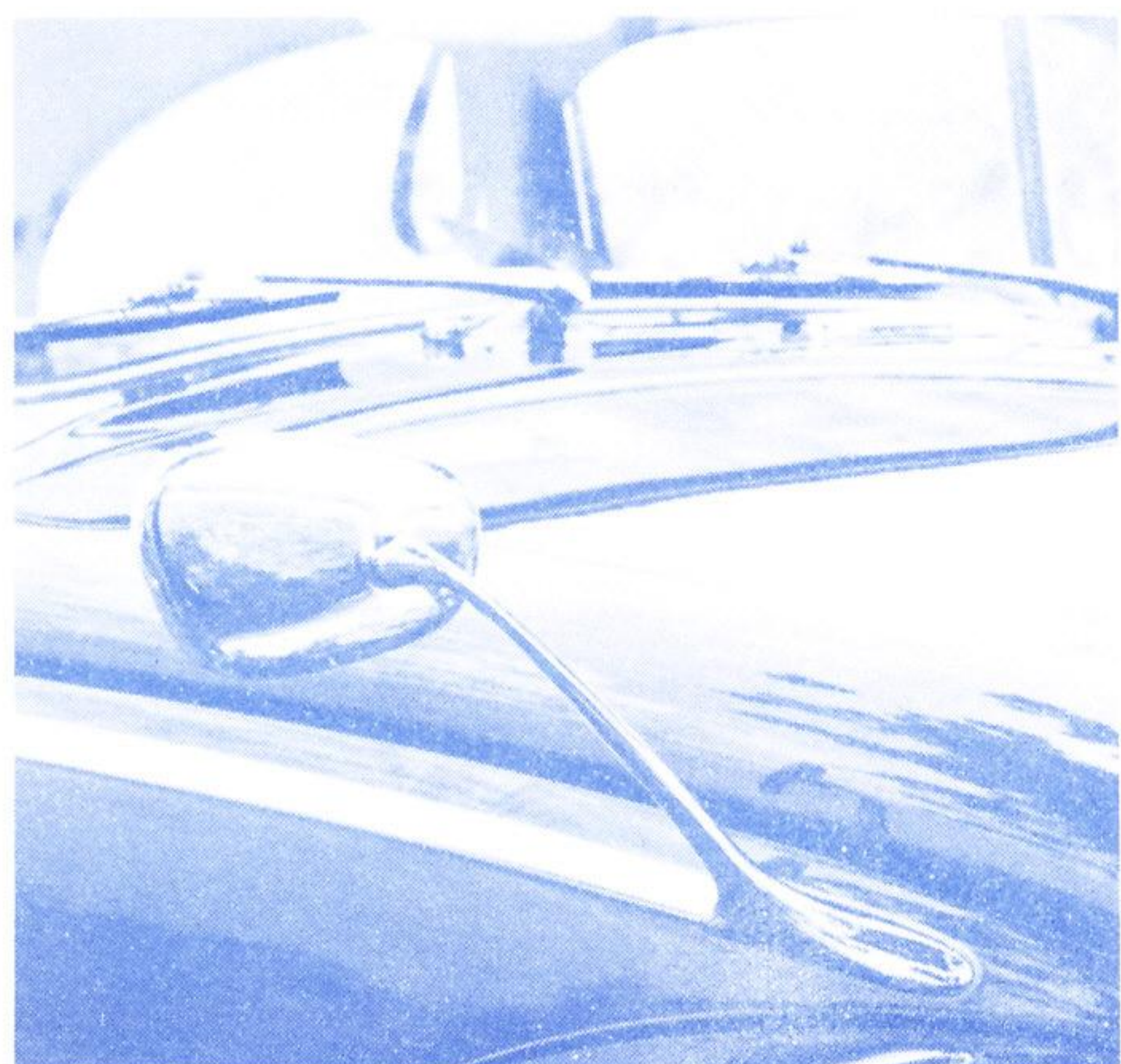

**BODY MOUNT . . .
WITH REPLACEABLE GLASS**

A unique mirror! Engineered in Germany, it attaches to the front of the chrome body strip and there are no holes to drill! It locks firmly in place! Mirror glass is available flat or convex and is easily replaced. Frame is heavily chrome plated for lifetime service. Specify left or right side, flat or convex glass, when ordering.

No. 671 **\$ 4.95** each

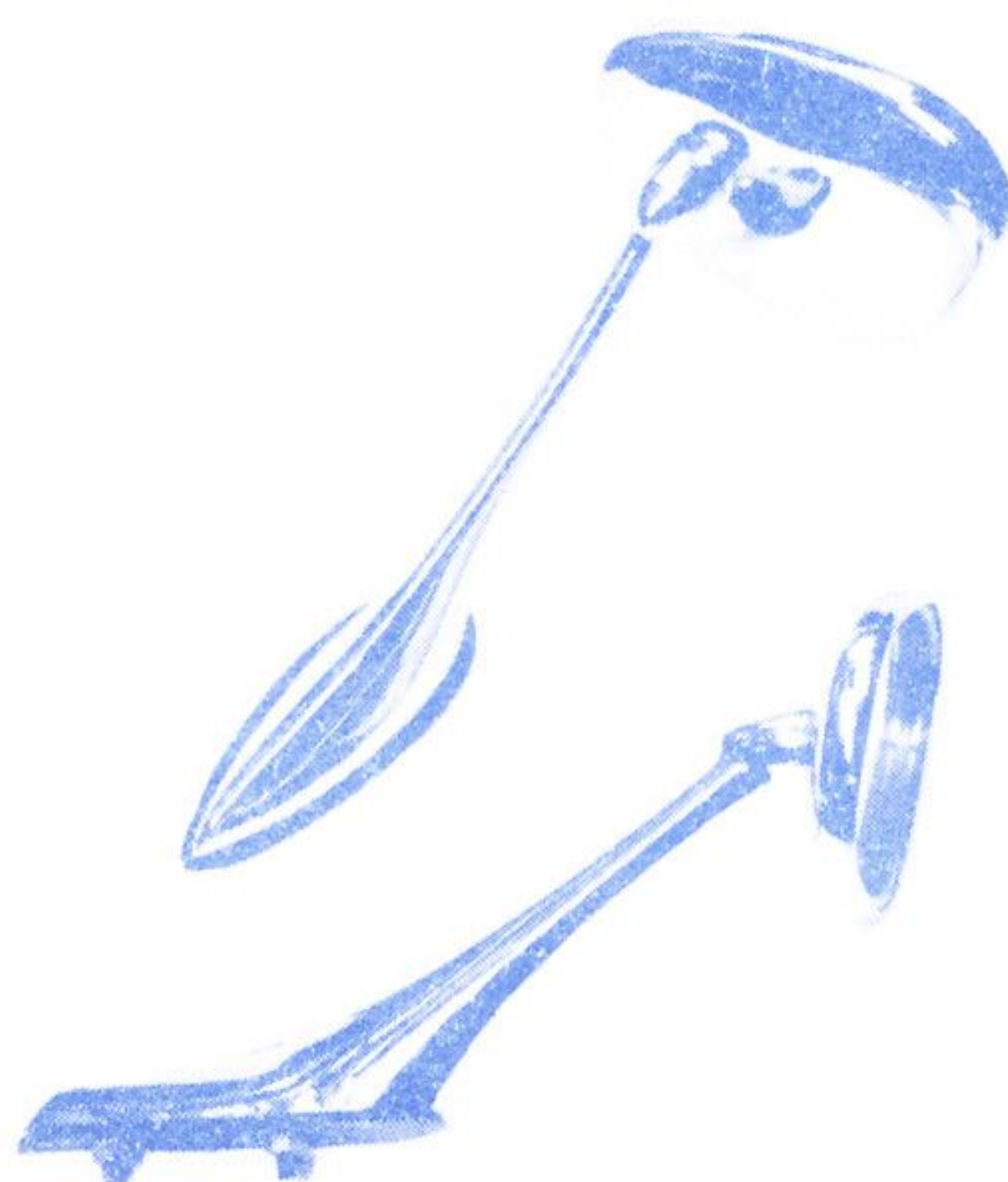

**FENDER MOUNT . . .
CONTINENTAL STYLE**

Handsome new continental-style mirror to complement the looks of your Ghia. It has replaceable glass which is available flat or convex. Available for left or right side. Specify side and choice of glass when ordering.

No. G-4 **\$ 6.25** each

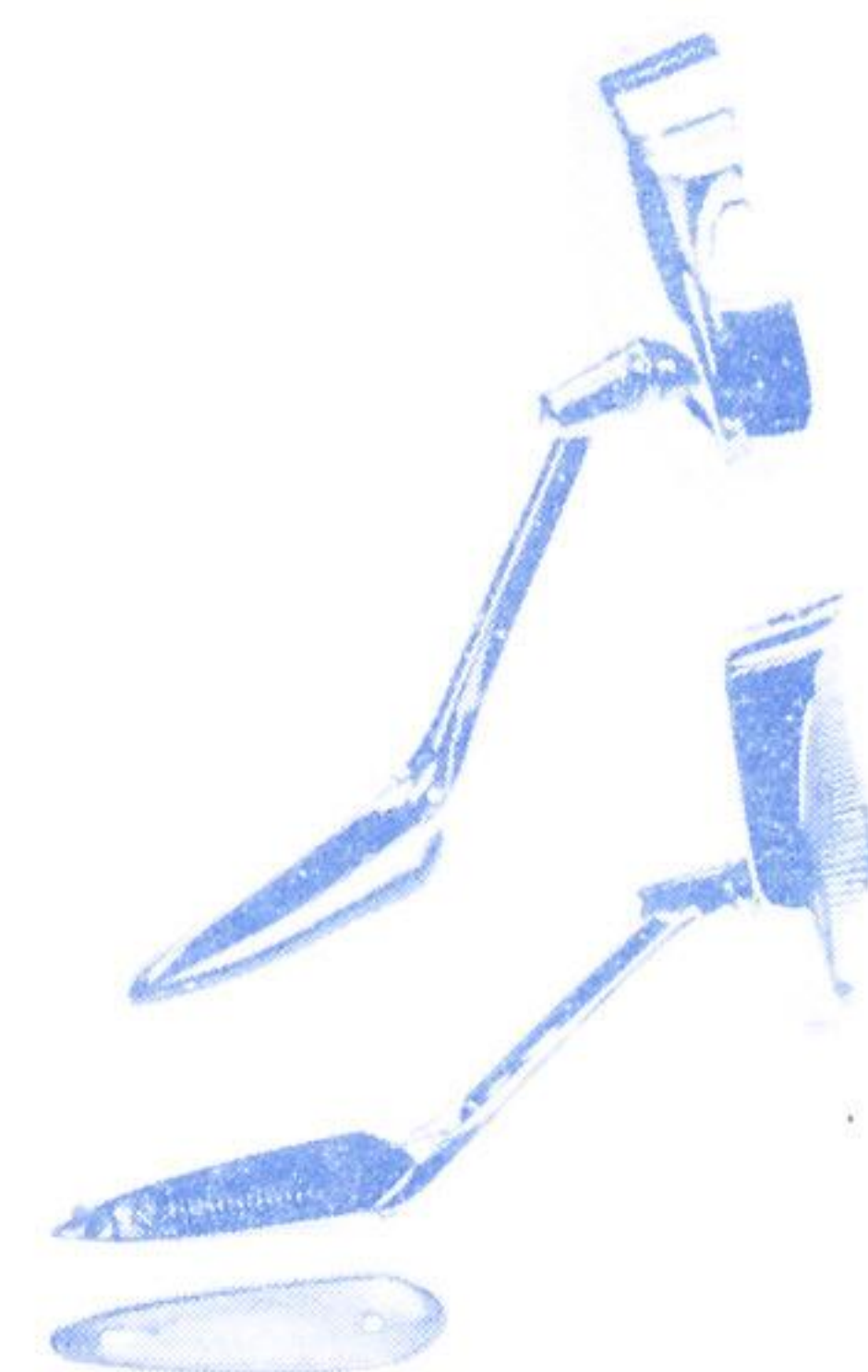

**DELUXE FENDER MOUNT
. . . WITH SHADE**

Deluxe model also has replaceable glass, a smoothly sculptured shade to help keep off rain or snow and a spring-loaded arm; it will "ride" with any accidental impact and then return to normal position. Specify left or right side, flat or convex glass, when ordering.

No. G-5 **\$ 6.95** each

SIDE MIRRORS FOR TRANSPORTERS

Beautiful, full-view outside mirrors give you a wide-angle look behind. Fully adjustable up, down and sideways. Will fit either left or right side of all transporter models. Excellent construction and revolutionary new Enduro-Chrome 4 layer plating process insures long life under the toughest conditions. Installation is easy, complete instructions furnished. Mount one on each side for safer driving. Dimensions: 11" x 5".

No. 659 Deluxe Chrome **\$15.75** each
No. 659-H Hammertone Head **10.95** each

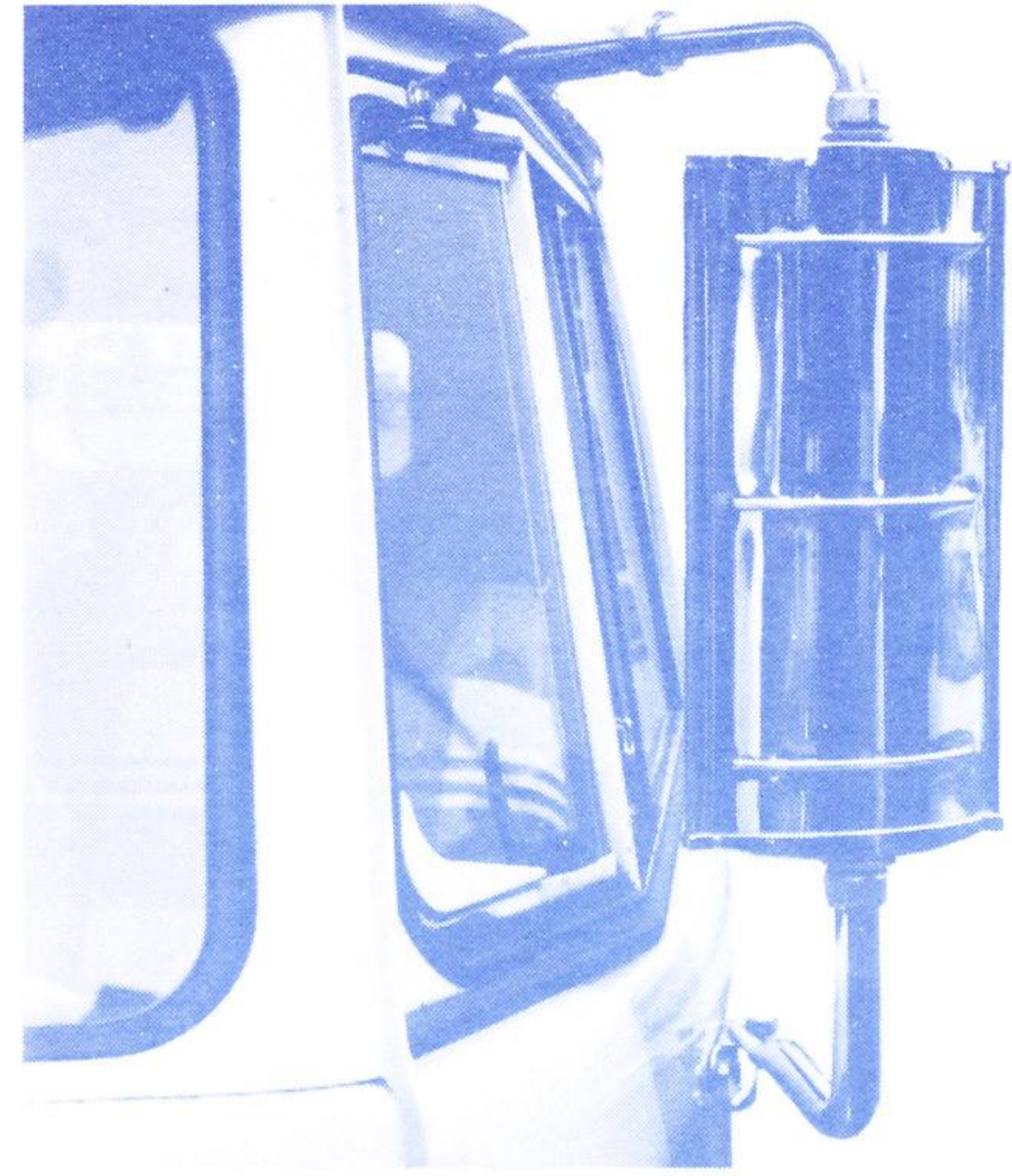

TRANSPORTER STEPS

For passenger's and driver's side, an assist step that mounts simply to any transporter. Installation requires no drilling; attaches through bumper support bolt and is rattle-free! A real help for the ladies!

No. 40 **\$ 6.95** per pair



SIDE STEP FOR TRANSPORTERS

Make better, safer use of the side doors with this wide, sure-footed auxiliary step. Fits quickly onto all transporter models. Installation is very secure and fool-proof; requires only four holes. Solid welded construction, with non-slip surface. Color; black.

No. 41 **\$24.95** each



RESERVE GAS CAN

Holds 2 1/4 gallons of emergency fuel! Wastes no precious storage space for it stores conveniently in the rim of the spare wheel. Three spring clips and a rubber gasket prevent rattling. Built in, self-emptying brass spout eliminates need for a funnel. Patented self-locking cap prevents leakage or escape of vapors. Interior is zinc-coated to prevent rust. Extra heavy gauge steel used throughout. Ideal for the camper and outdoorsman. For VW sedans, sunroofs and convertibles, all years.

No. 355 **\$10.95** each

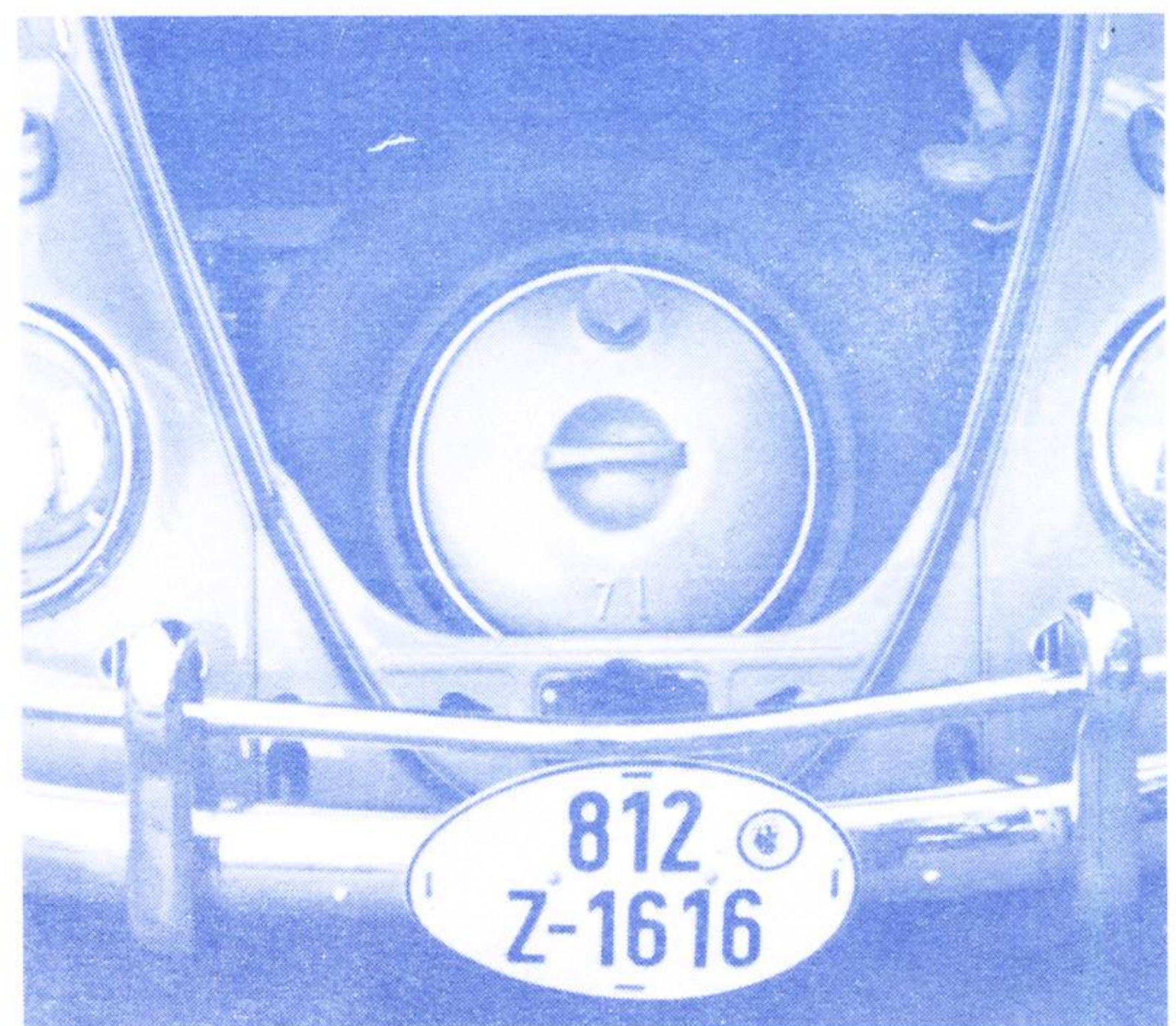

811 PROSPECT AVENUE

POLY PAD IMPORTS

CLEVELAND, OHIO 44115

Accessories for the Volkswagen Owner

WHEELS!

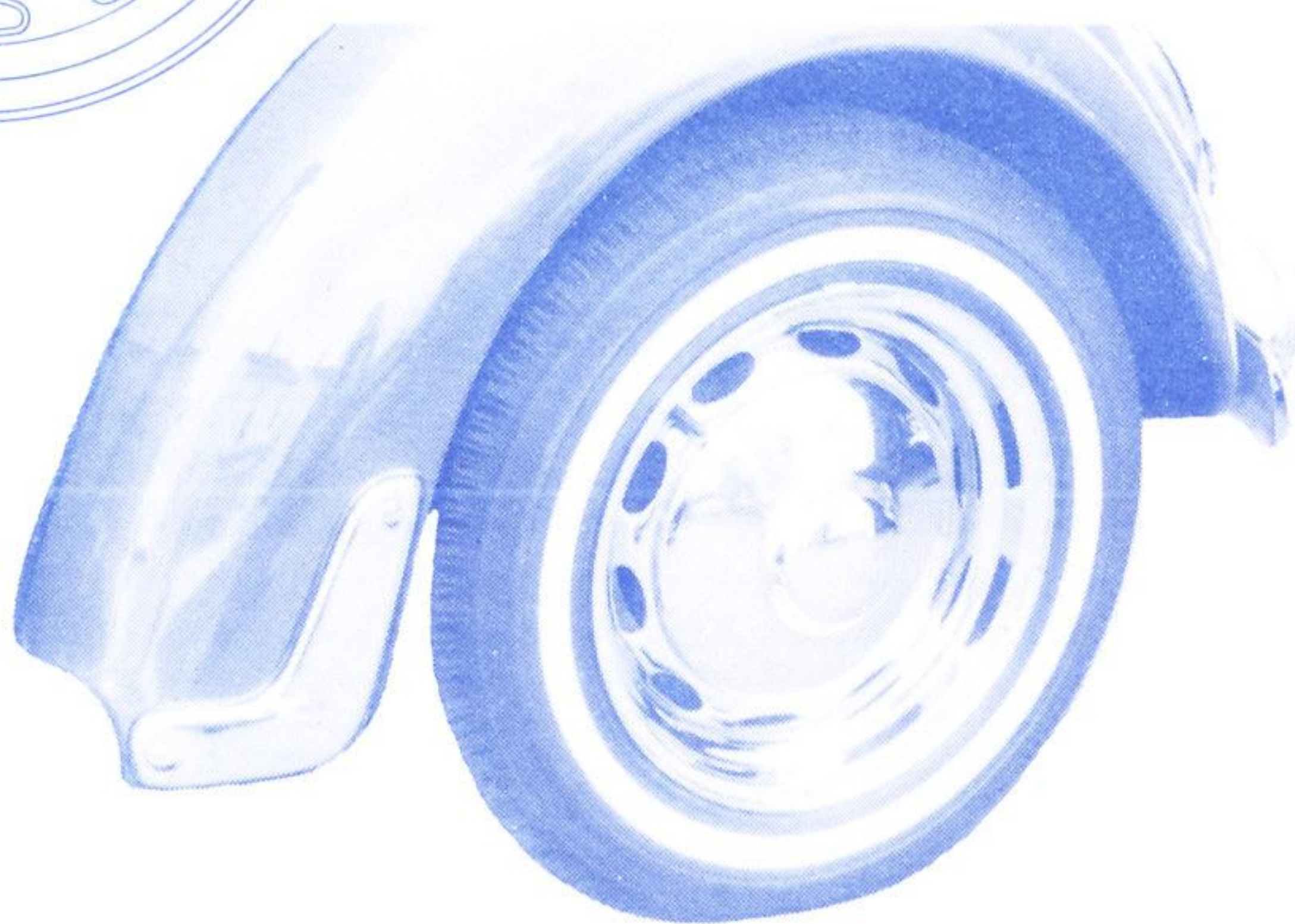

new STANDARD WHEELS for all 1200's

Stock wheel available in plain or slotted style, as drawing.

- | | |
|--------------------------------|--------------|
| No. 4100 Prime Coated, Plain | \$ 9.50 each |
| No. 4110 Prime Coated, Slotted | 11.95 each |

new PORSCHE, CHROME WHEELS

Standard wheel, heavily chrome plated, for 1964-65 Porsches with disc brakes.

- | | |
|----------------------------|--------------|
| No. 4160 For Porsche 64-65 | \$29.50 each |
|----------------------------|--------------|

THE "STUTTGART" HUB CAP

Porsche style preferred by many sports car drivers. Dome is indented to prevent curb scratches. Heavily chrome plated. Especially impressive with chrome offset wheels or slotted wheel rings shown.

- | | |
|---------|--------------|
| No. 436 | \$ 3.85 each |
|---------|--------------|

SLOTTED WHEEL RINGS

Smart, slotted design rings add much eye appeal. Lock firmly under any hub cap. Fit VW's, Ghias and Transporters.

- | | |
|----------------------------|------------------|
| No. 3920 Anodized aluminum | \$ 9.95 set of 4 |
| No. 25 Polished aluminum | 5.50 set of 4 |

"HAMBURG" HUB CAP

Gleaming chrome, smooth dome hub cap for the custom look. For all Volkswagens, Ghias and Transporters.

- | | |
|---------|--------------|
| No. 432 | \$ 3.95 each |
|---------|--------------|

LOUVERED WHEEL RINGS

Handsome, bright rings made in Germany. Lock firmly in place behind any hub cap. Will fit Volkswagens, Ghias and Transporters.

- | | |
|----------------------------|------------------|
| No. 3427 Anodized aluminum | \$ 9.95 set of 4 |
|----------------------------|------------------|

Detailed below is a listing of various wheels made especially for Poly Pad Imports by Lemmerz of Germany. All are constructed of the finest materials and meet all pertinent specifications for engineering and safety. All will fit the cars listed perfectly and will accept tube or tubeless tires of standard size used on that car. Each is thoroughly inspected and tested. Poly Pad Imports unconditionally guarantees each wheel.

NEW OFFSET WHEELS for all Volkswagens, Porsches

Better Roadability and Cornering: Offset of 1/2" per wheel increases track by a full inch!

Safer: Rim is 1/2" wider than standard to minimize tire "roll" on high speed turns, to increase tire life.

Handsome: Porsche styling wins prizes! Open slotted design gains points at Concours events!

Fit all year VW's and also Porsches through 1963.

- | | |
|------------------------|--------------|
| No. 4000 Chrome Plated | \$29.50 each |
| No. 4050 Prime Coated | 11.95 each |

new CHROME for VOLKSWAGEN 1500's

SLOTTED STYLE, as picture, heavily chrome plated, without offset.

- | | |
|---|--------------|
| No. 4150 Chrome plated -
for all VW 1500's | \$28.95 each |
|---|--------------|

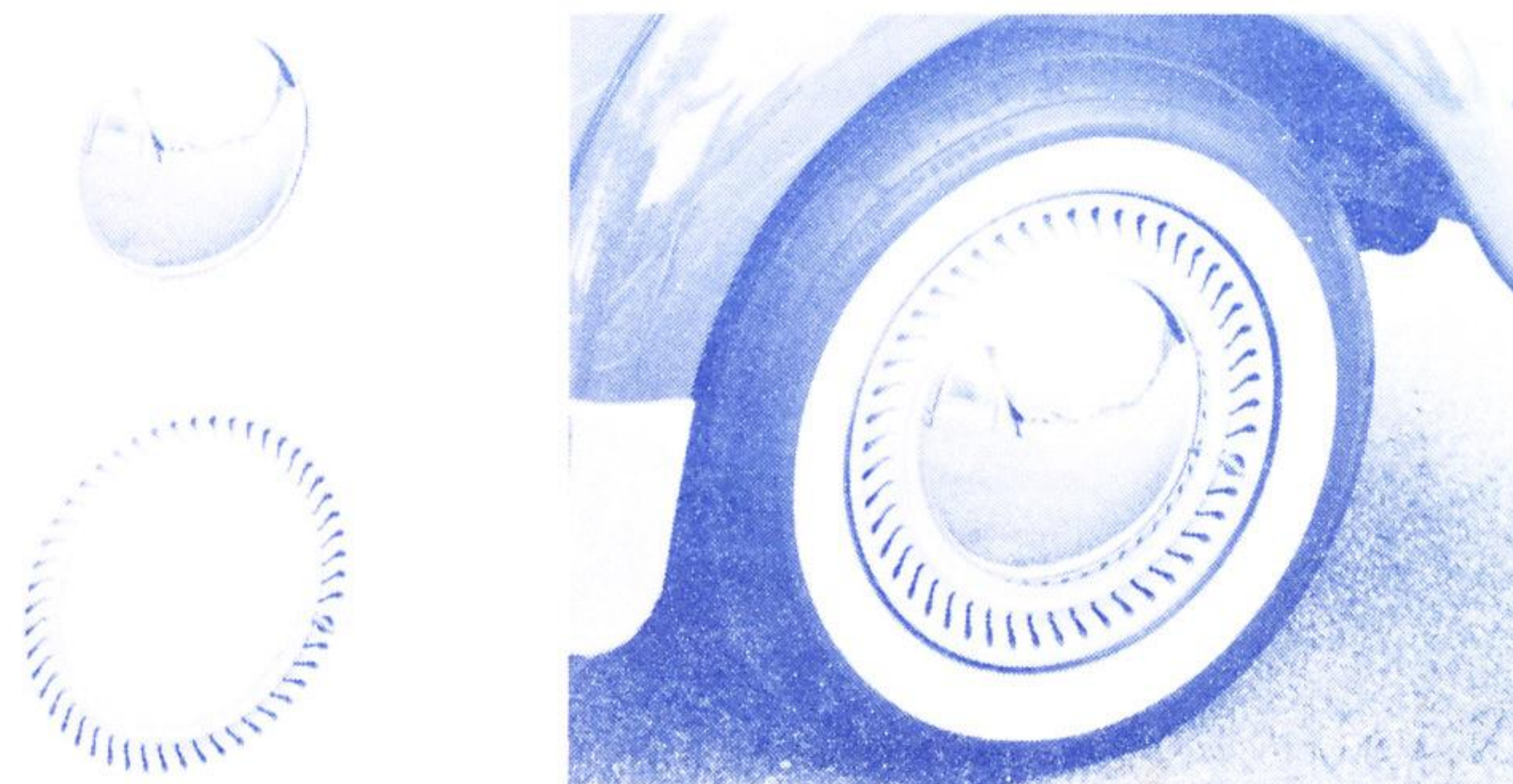
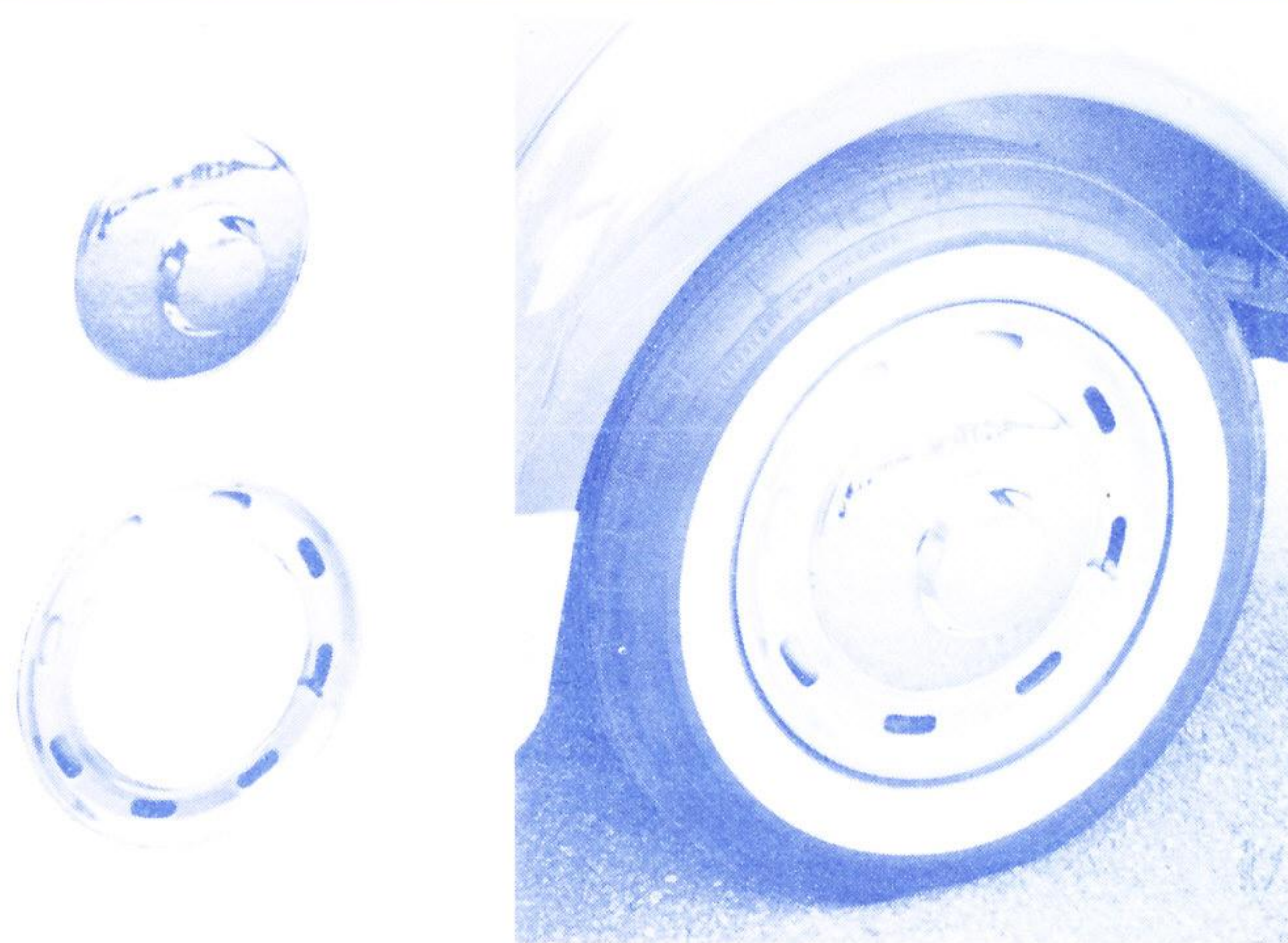

ADJUSTABLE REAR QUARTER WINDOWS
 . . . for fresh air, better circulation

One of the most practical accessories available for the VW sedans or sunroofs. Up-dates your favorite automobile! Our model will lock open in a variety of positions. Installation is not difficult and requires no special tools. Kit consists of all new windows, sealing gaskets, hardware, all needed parts, and complete instructions.

No. 576 All VW sedans or sunroofs thru 1964
\$29.95 per set of 2 complete

No. 576A All 1965 VW sedans or sunroofs
\$49.95 per set of 2 complete **NEW**



NEW **RUNNING BOARD TRIM**
 . . . stainless steel!

Perfect replacement trim now available in stainless steel. Withstands ravages of winter salt better than anodized aluminum. Easily installed; new clips supplied. Replace bunged-up trim now, inexpensively. Fits all year VW sedans and convertibles.

No. 1110 For right or left side **\$ 3.25** each



THRESHOLD PLATES **NEW**

Good looking stainless steel threshold plates to cover old, worn painted area under the door. For all VW sedans.

No. 42 **\$ 6.95** per pair

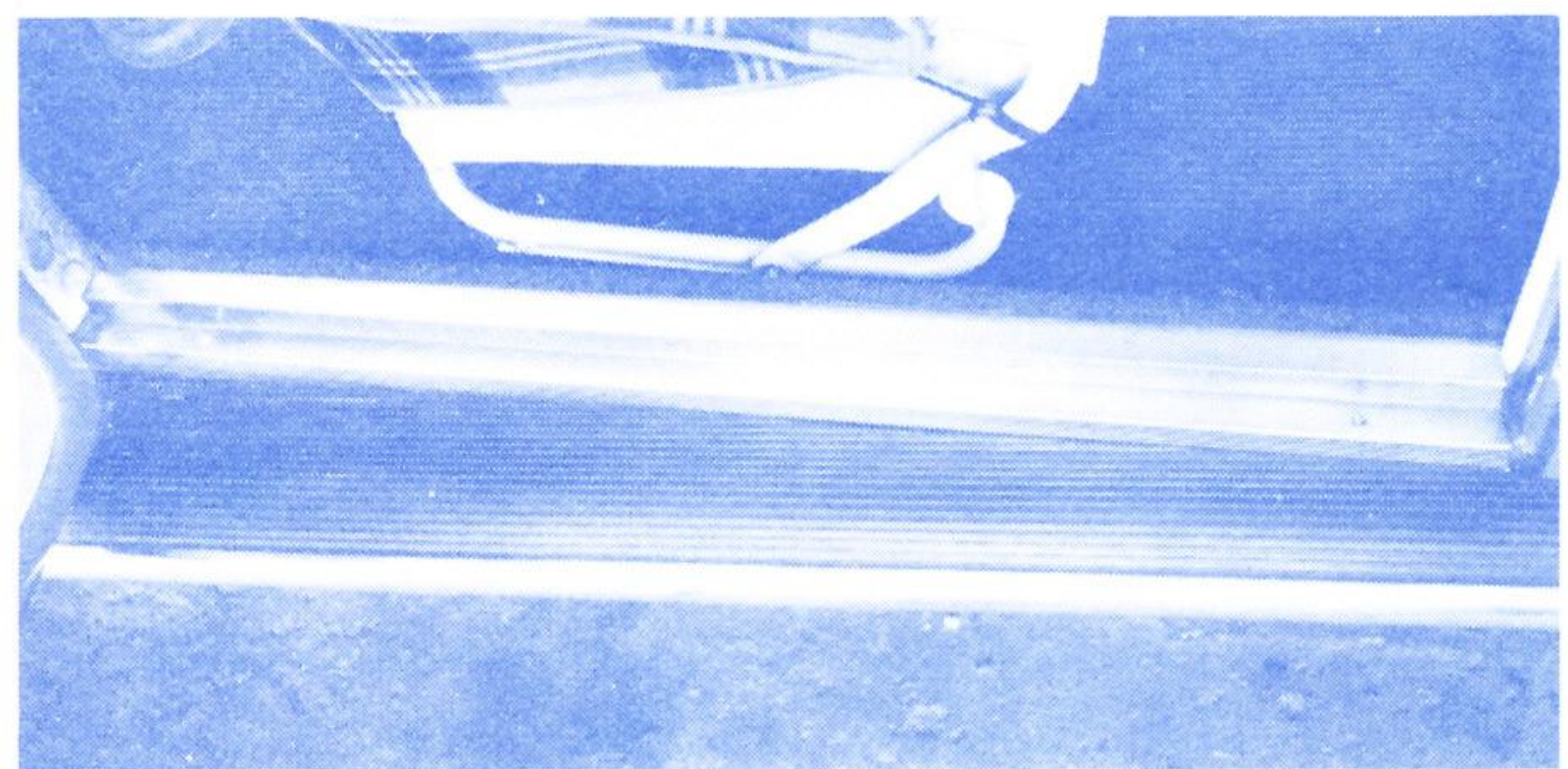

RAIN GUTTER TRIM

Dress up your car; give it outline! The correct length of trim to cover the entire rain gutter. Does not interfere with mounting of luggage racks, wind deflectors. For all sedans and sunroofs.

No. 160 **\$ 2.95** per pair



SCHAFFER CLAW

Used for removing hub caps without marring wheel paint. Handy tool stores in the jack socket and its bright chrome plated cap dresses up your Volkswagen's appearance.

No. 404 **\$ 1.95** per pair

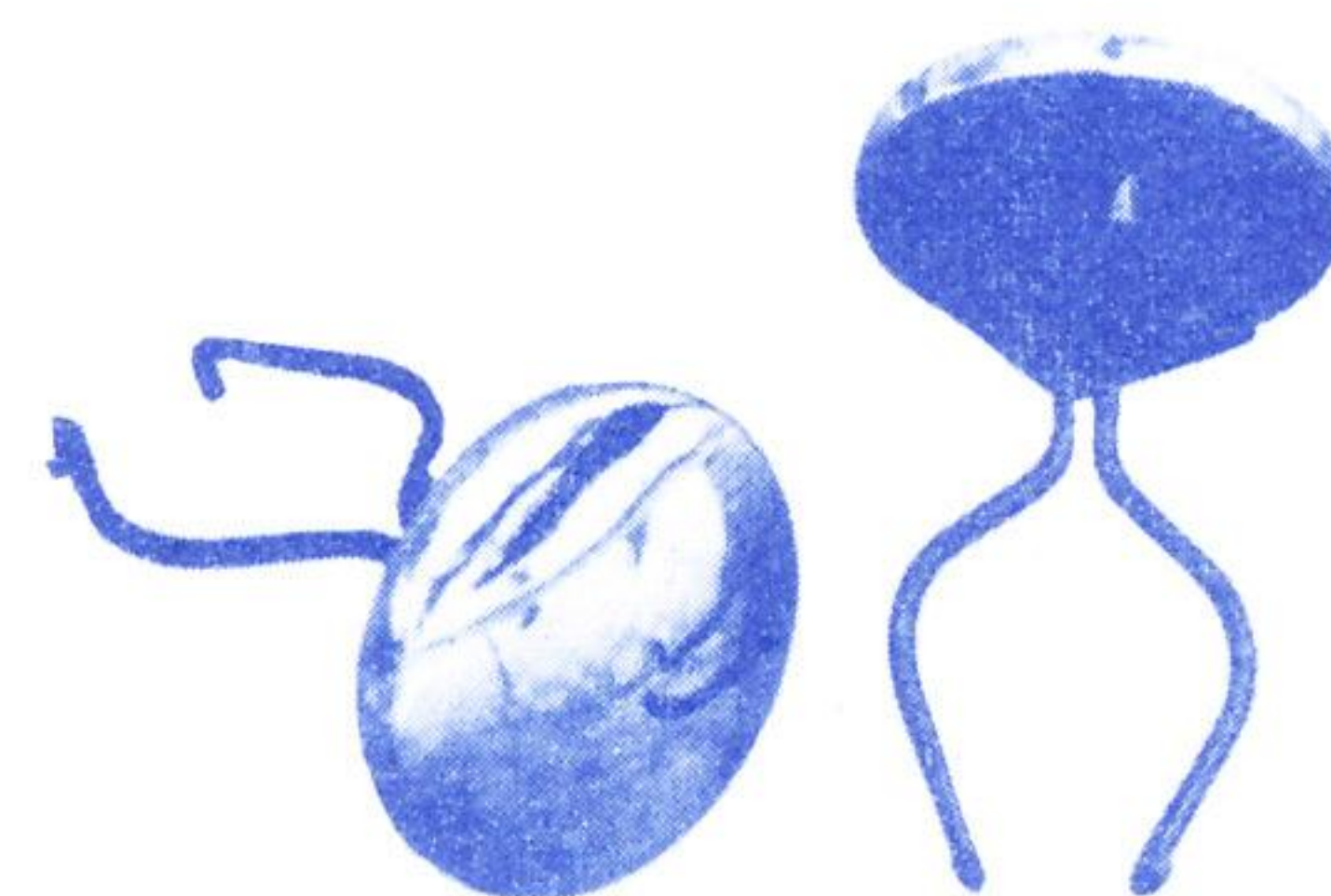

811 PROSPECT AVENUE

POLY PAD IMPORTS

CLEVELAND 15, OHIO

Accessories for the Volkswagen Owner

EXTERIOR ACCESSORIES

VENTSHADES

The original VENTSHADES! Allow windows to be left partially open in the hardest rain. Added protection from the setting sun, too. Ventshades add to the appearance of your VW. Made of highly polished stainless steel, Ventshades won't rattle or rust. Easy installation. For all sedans and sunroofs.

	No. V-1	Models through 1964	\$ 6.50	per pair
new	No. V-1A	For 1965 models	\$ 6.50	per pair



VENT WINDOW DEFLECTOR

Keep the rain out! Easy installation: slip them under the vent window gaskets and they remain firmly locked in place. No holes to drill! Heavy chrome plated. Fit all sedans, sunroofs and convertibles.

No. 187	\$ 3.95	per pair
---------	---------	----------

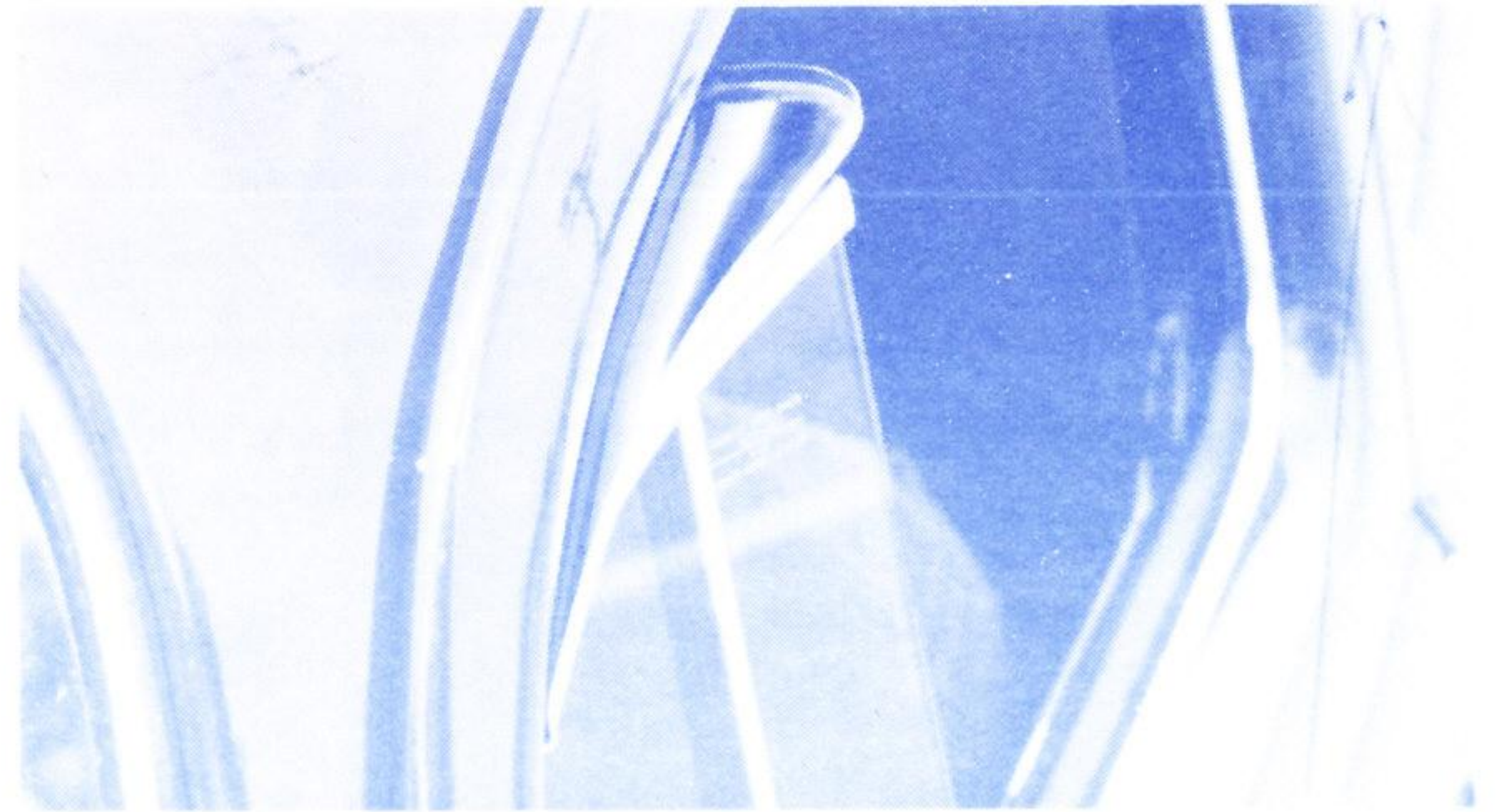

DOOR LATCH COVERS

Spring-loaded, swivel covers eliminate grease spots on clothing. Will not interfere with operation of door latch. Simple clip-in, permanent installation for all sedans, sunroofs and convertibles.

No. 490	\$ 2.95	per pair
---------	---------	----------

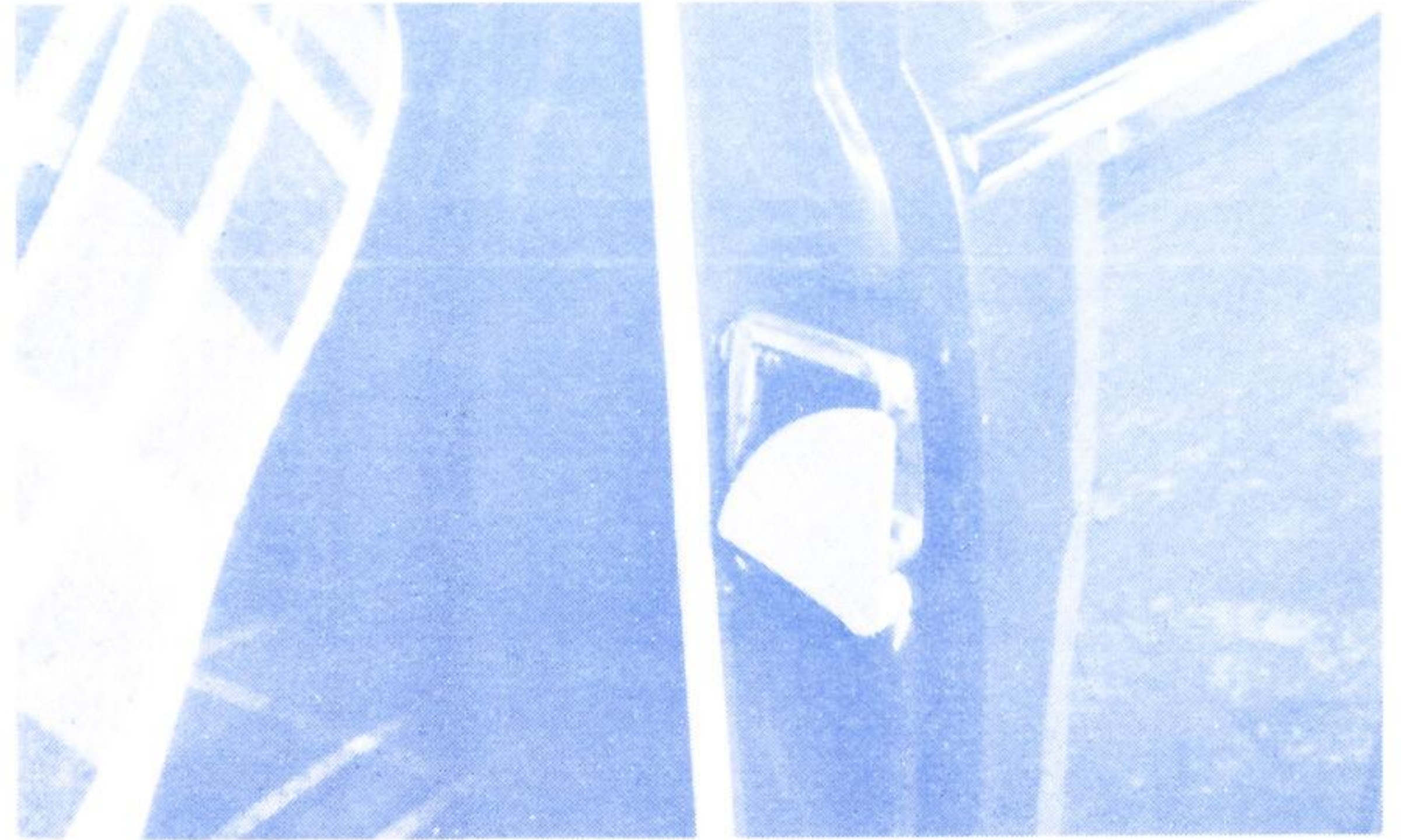

DOOR HANDLE GUARDS

Prevent scratches and paint wear around the door handles. Beautifully polished and chrome plated. No. 647 installs without the use of screws. Early model requires one screw. A touch of the custom look for your Volkswagen!

No. 646	All models to 1959	\$.75	per pair
No. 647	All models 1960 thru 1965	2.25	per pair

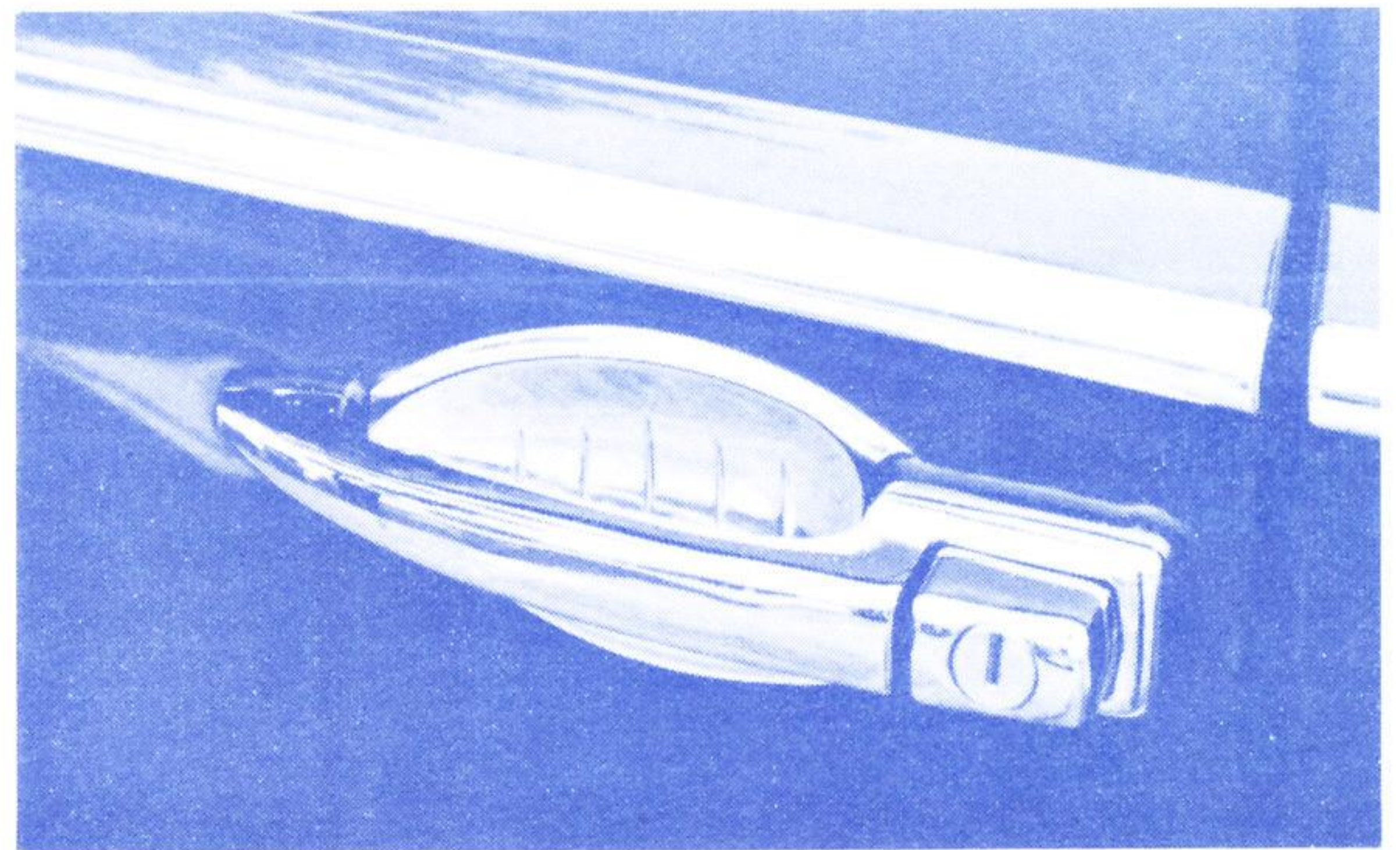

DOOR BUMPERS

Solid rubber bumpers eliminate the problem of chipped door edges. They'll absorb the punishment from other car doors and garage walls. Easy installation.

No. 172	\$ 1.75	per pair
---------	---------	----------



GRAVEL GUARDS

Protect the most vulnerable spot on your car from flying stones and gravel. These heavy duty guards, our exclusive import, are made of heavy-gauge steel, brass-plated, then heavily chrome plated — not the ordinary polished alloy variety. Our guard will withstand more punishment and look far better over the years, and protect a larger area than others. No drilling or alterations. Complete and ready to install. For all sedans and convertibles.

No. 7150 Rear Guards \$ 4.75 per pair
No. 6650 Front Guards \$ 4.95 per pair

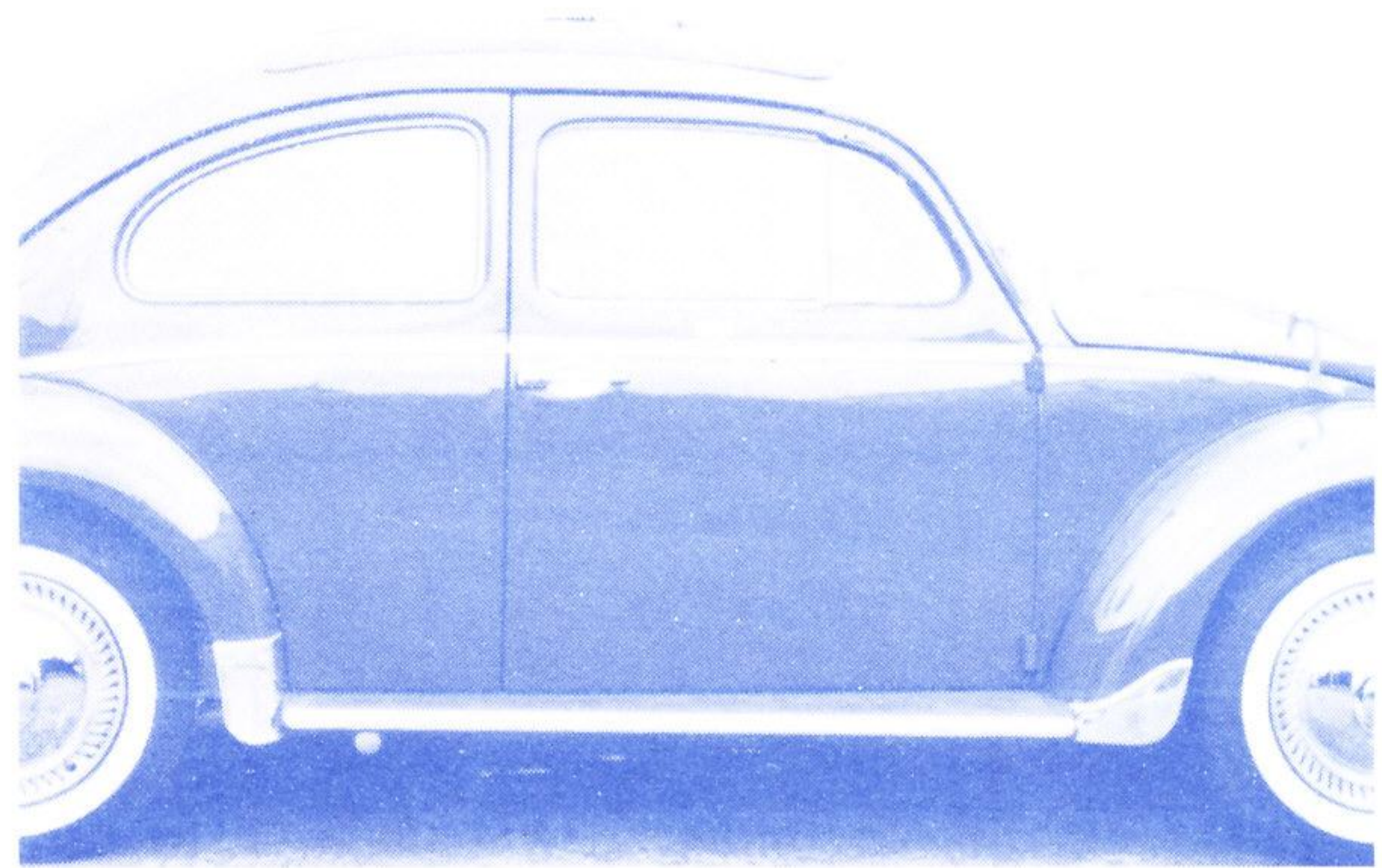

BUG AND GRAVEL SCREEN

Prevents bugs, gravel and stones from marring the front of your Volkswagen. Saves the trouble and cost of touching up the front of your car. Made from high quality materials for hard road use. Easy to attach. Hood support bracket allows quick access to the front luggage compartment. For all 1200 sedans and convertibles.

No. 125 \$ 8.95 each

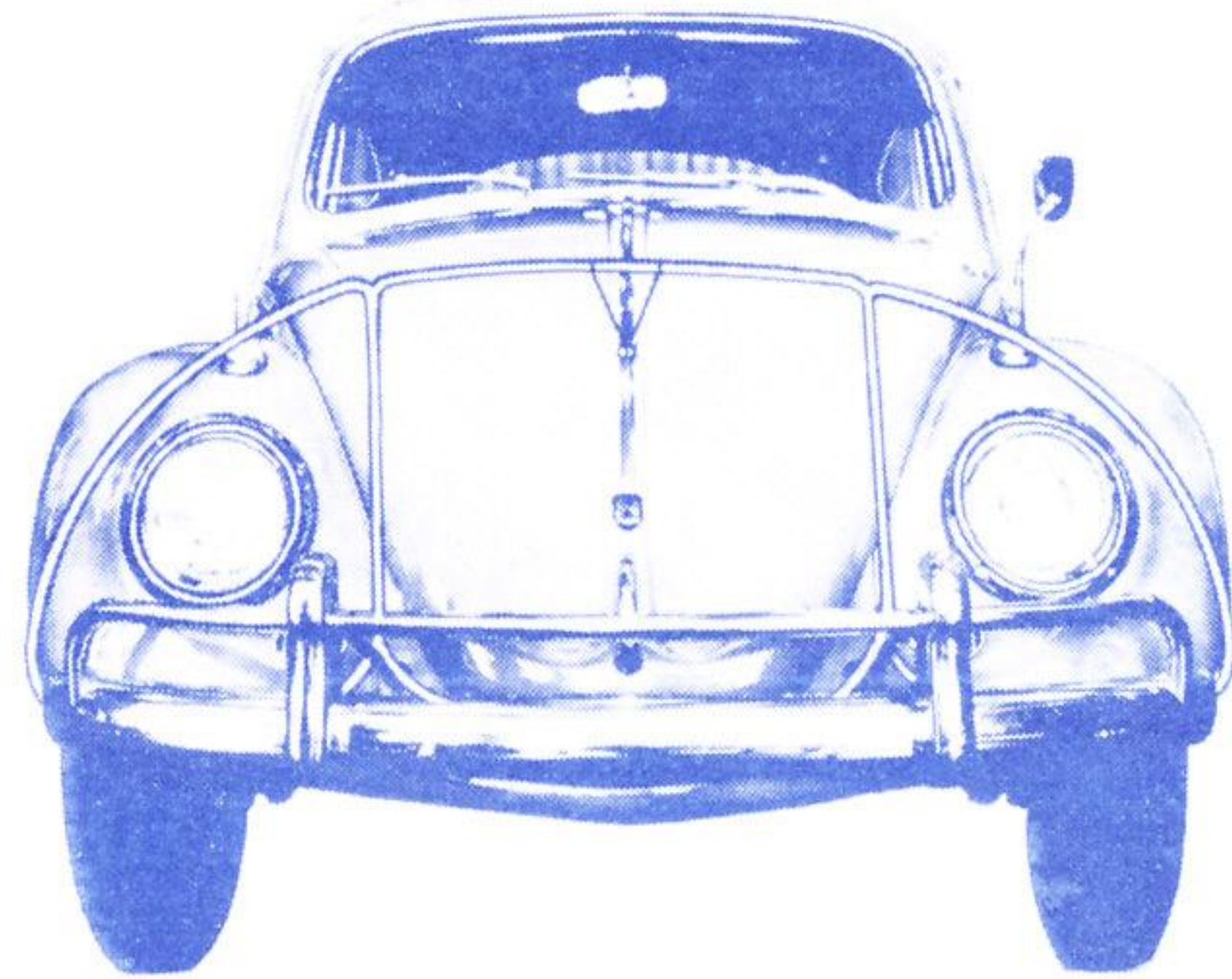

WINDBREAKER . . . Newly designed

Stop annoying air rumble when sunroof is open with this durable windbreaker. Made of 1/4" plexiglas. Designed especially for the hard top sunroof, and convertible. Blocks gusty ventilation and reduces fatigue from noise and windroar. Get more enjoyment from your VW sunroof on windy days or chilly evenings! Finest European construction. Installs in a matter of minutes.

No. 499 \$14.95 each

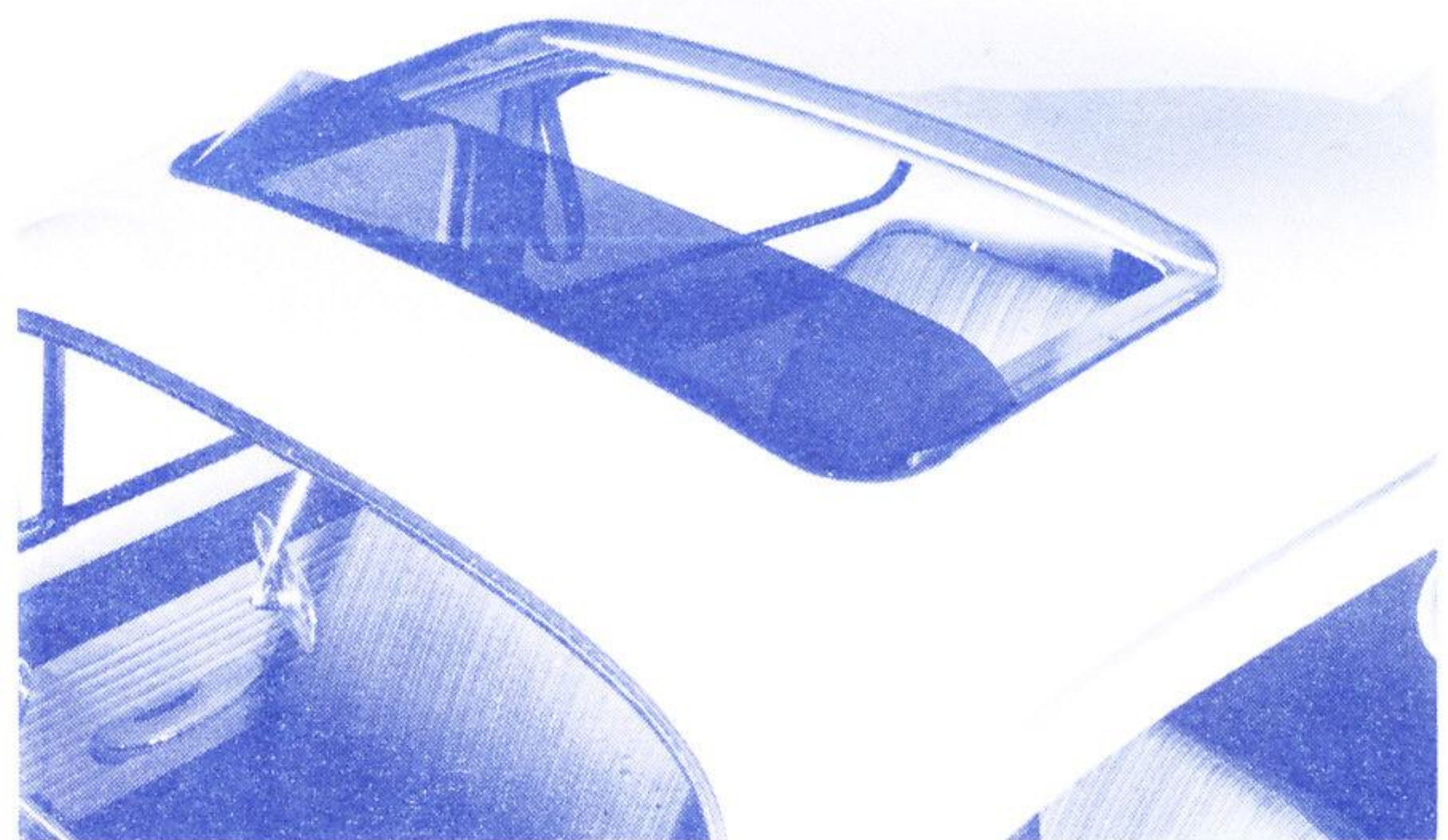

WIPER BLADE CONVERSION KIT

Volkswagen owners can now change over to specially designed TRICO wiper blades and arms. Proven in operational tests to provide VW owners with the same high standard associated with TRICO equipment on American-made cars. Change over is done without complete arm replacement; converters are easily installed in the VW standard equipment arm heads and match exactly the original arm finish.

W-102 For all sedans and convertibles from 1959 on. Contains two 9" wiper blades, two arm converters. \$ 3.00 each
W-103 For all transporters. Contains two 11" wiper blades, two arm converters. \$ 3.00 each

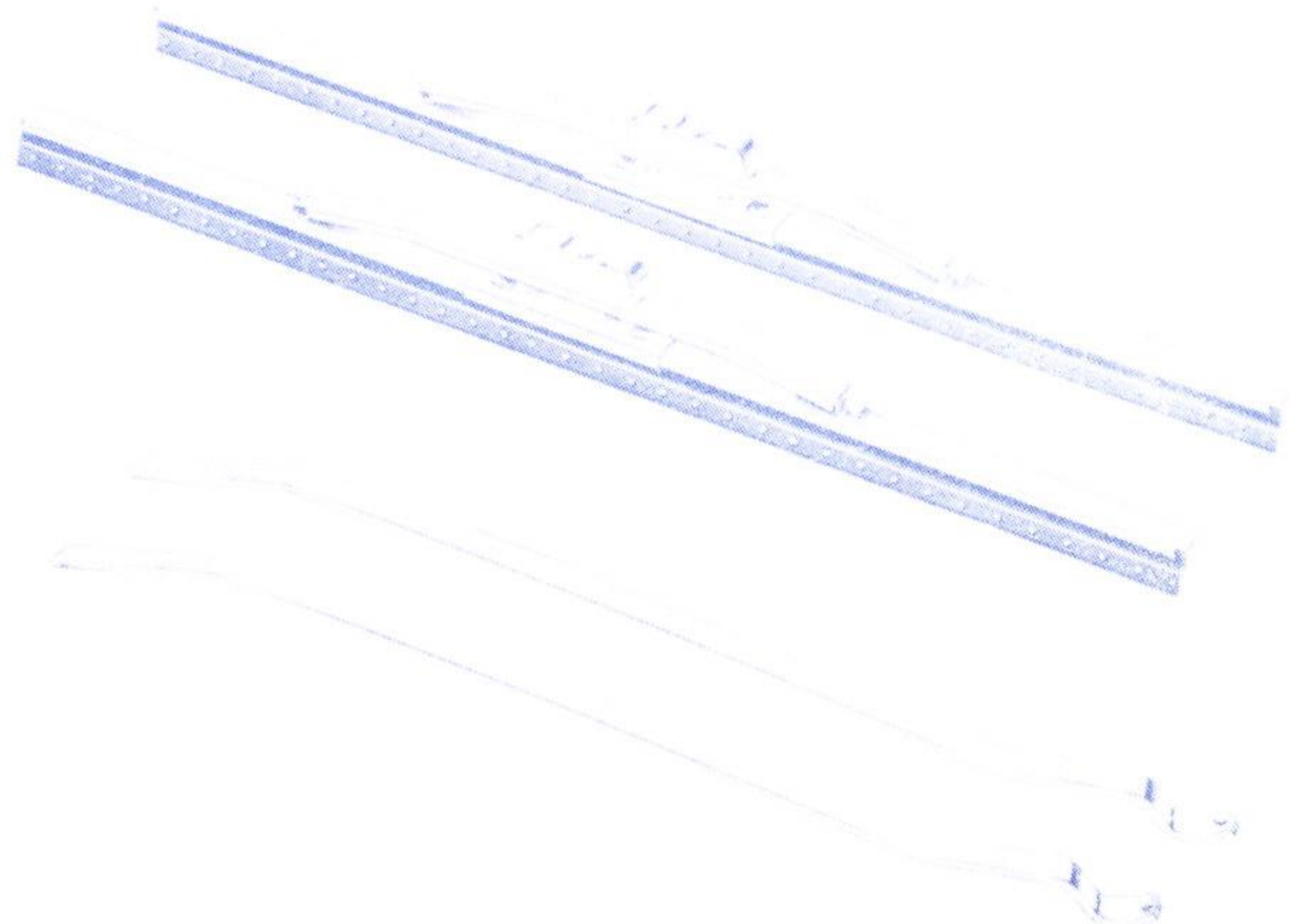

EXTERIOR ACCESSORIES

GRANDE GRILL

A Ghia goody! Treat your car to a new look. Polished duraluminum grill requires only 3 bolts to attach permanently. Guaranteed to stay bright and rust-free. Very sporty! People will think you own a Ferrari.

No. 29 For all Ghias \$18.75 each

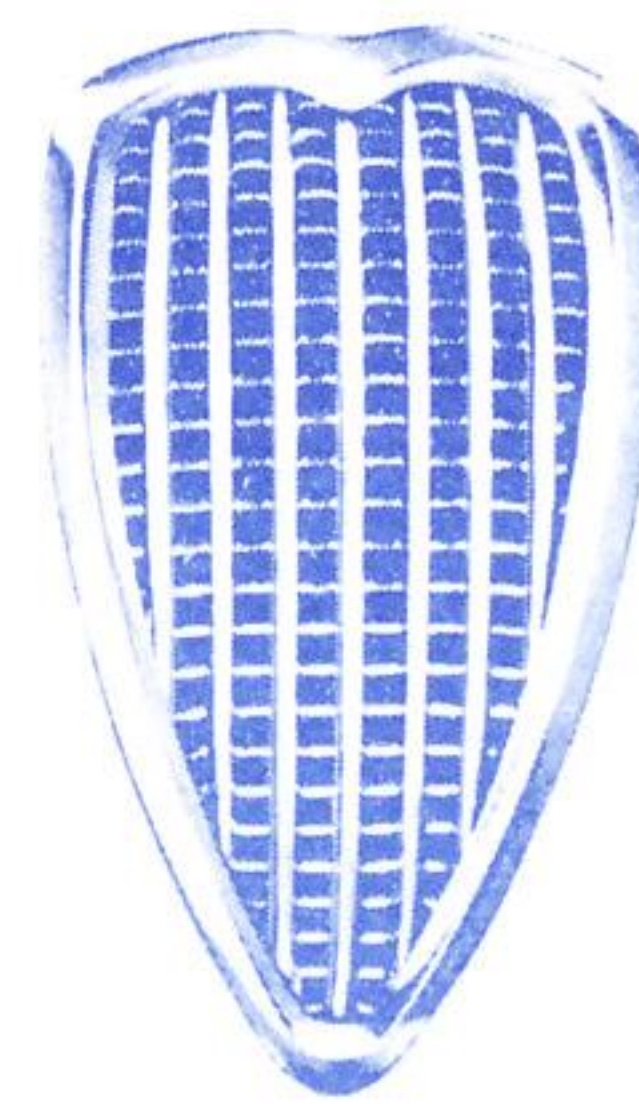

LOCKING ENGINE COMPARTMENT HANDLE

Keep "snoopers" out of your engine compartment. Perfect replacement for standard non-locking handles. Chrome plated. Comes complete with two keys. Mounting is simple and quick — no holes to drill.

No. 45 All VW 1200's thru 1964 \$ 3.95 each
No. 45A All 1965 VW 1200's \$ 3.95 each

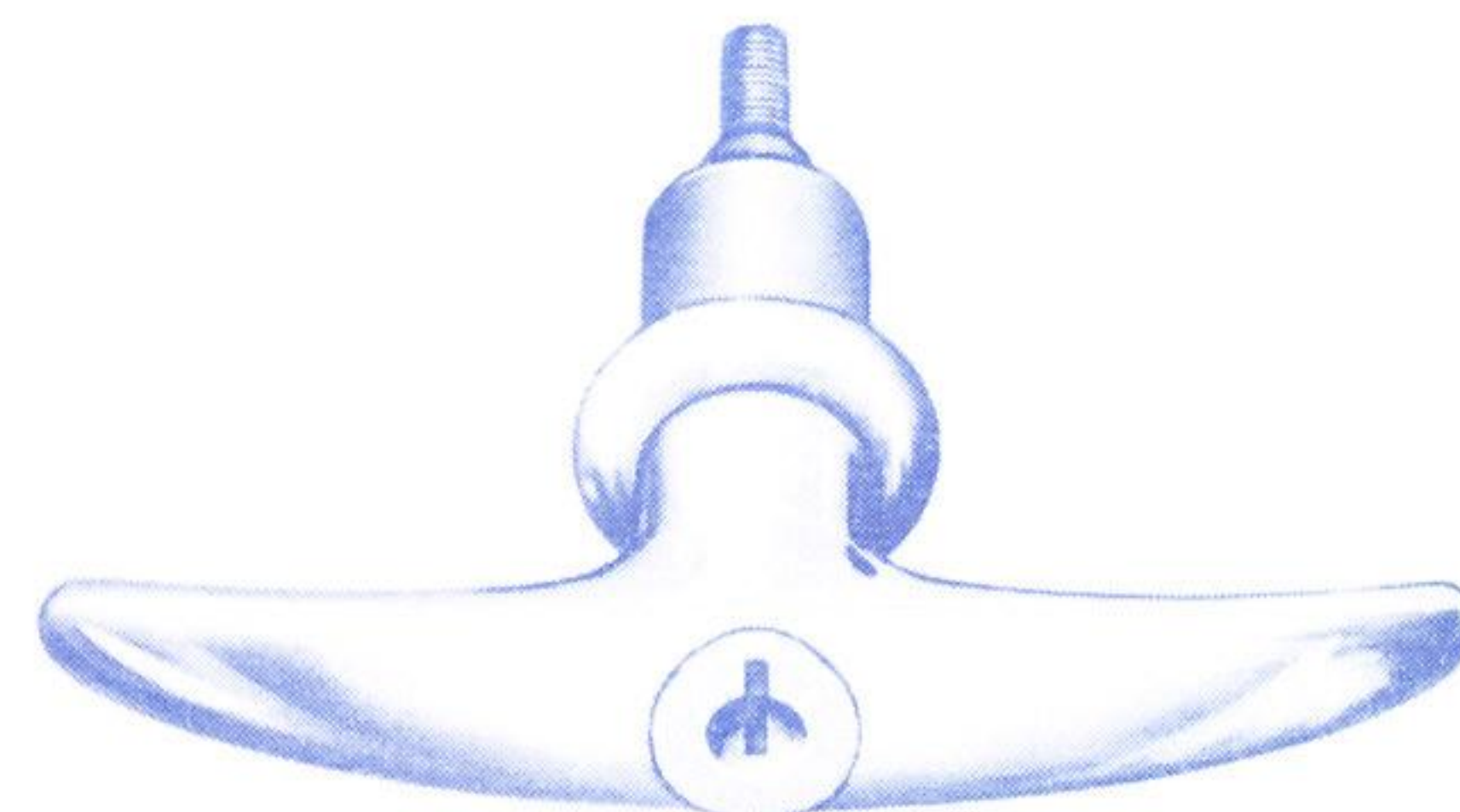

HOOD HANDLE GUARD

The custom look! Extra-heavy chrome shield dresses up and protects area around hood handle. Simple to install — complete with mounting gasket.

No. 48 \$ 1.95 each

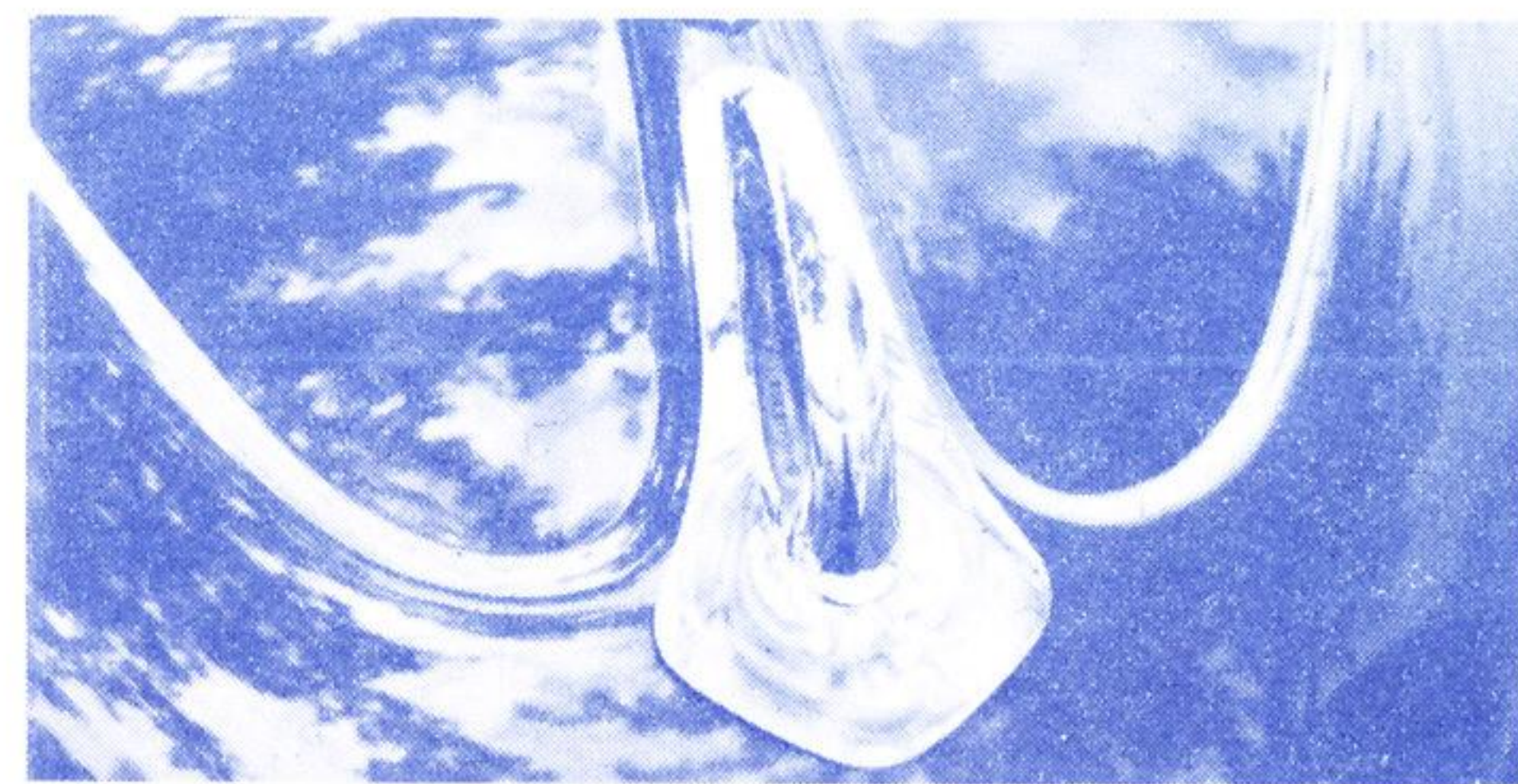

HEADLIGHT GUARDS

Protect your headlights from stone damage. Easy installation and removal. Perfect fit on all Volkswagen and Porsche's. Chrome plated. Used on many race and rally cars. Made in Germany.

No. 394 \$10.95 per pair

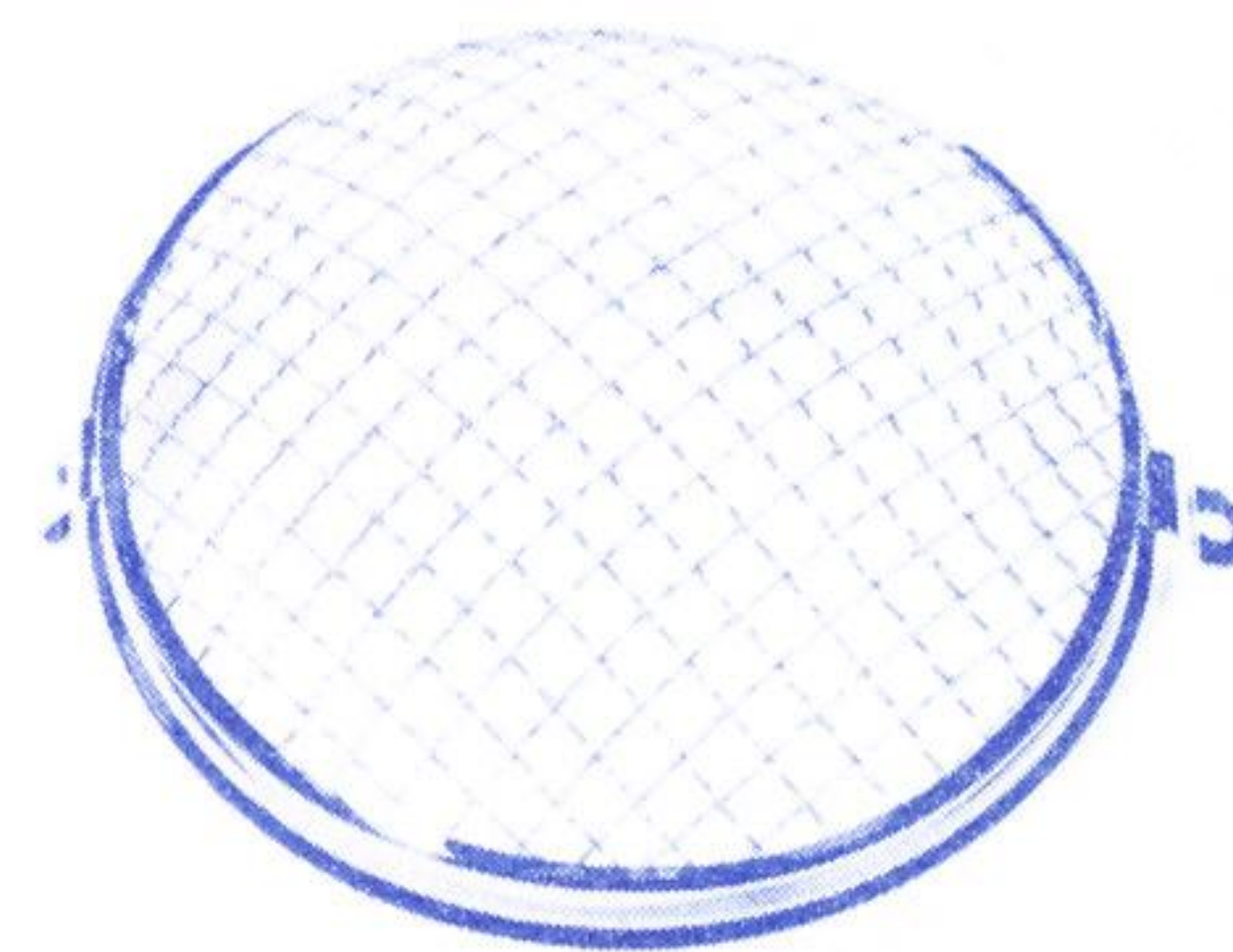

HEAD-LAMP VISORS . . . European style

Extra-heavy chrome plated steel visors concentrate more light on the road. Will not bend out of shape like ordinary stainless steel. Has a neatly rounded edge for added safety. Simply slip underneath headlight rims; no holes to drill.

No. 126 \$ 3.95 per pair



NEW

HORN GRILL

Brighten up your car. Here's a perfect replacement grill for the horn opening up front. Replace rusty, pitted grills now. Clips in place quickly; no drilling necessary.

No. 1133 \$.50 each

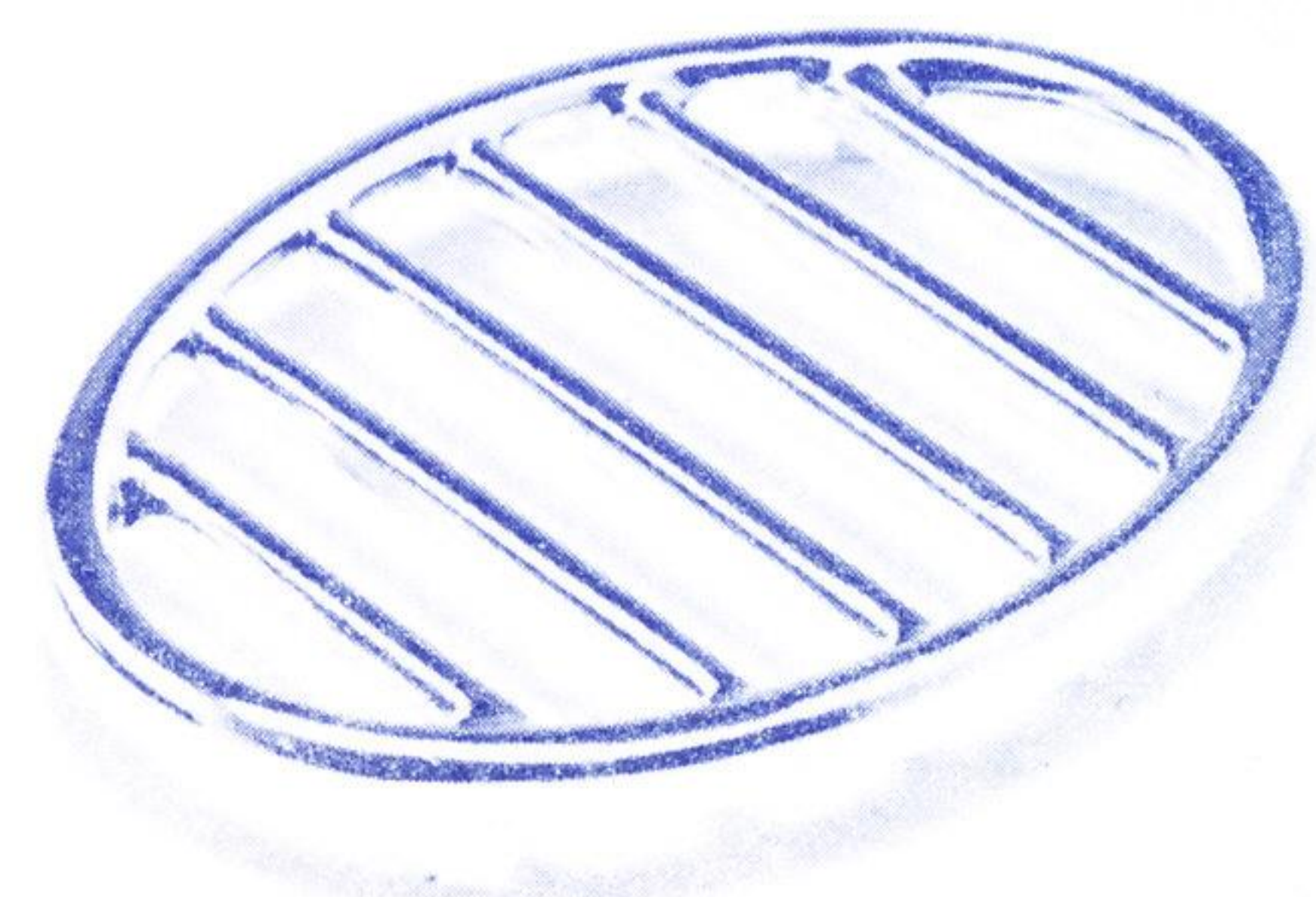

VENT LOUVER TRIM

Add this bit of bright-work to your Volkswagen. Fine looking chrome plated louvers quickly snap into place on intake vents for a simple, permanent installation. German made for precise fit, louvers will not rust or corrode. A very real improvement in the appearance of your car.

No. 912	Sedans 1958 thru 1963	\$ 6.75 per set
No. 912A	Sedans 1964 - 1965	6.75 per set
No. 913	Convertibles 1958 on	5.75 per set
No. 914	Sedans to 1957	6.75 per set
No. 915	Convertibles to 1957	6.25 per set
No. 916	Ghia all years & models	6.95 per set

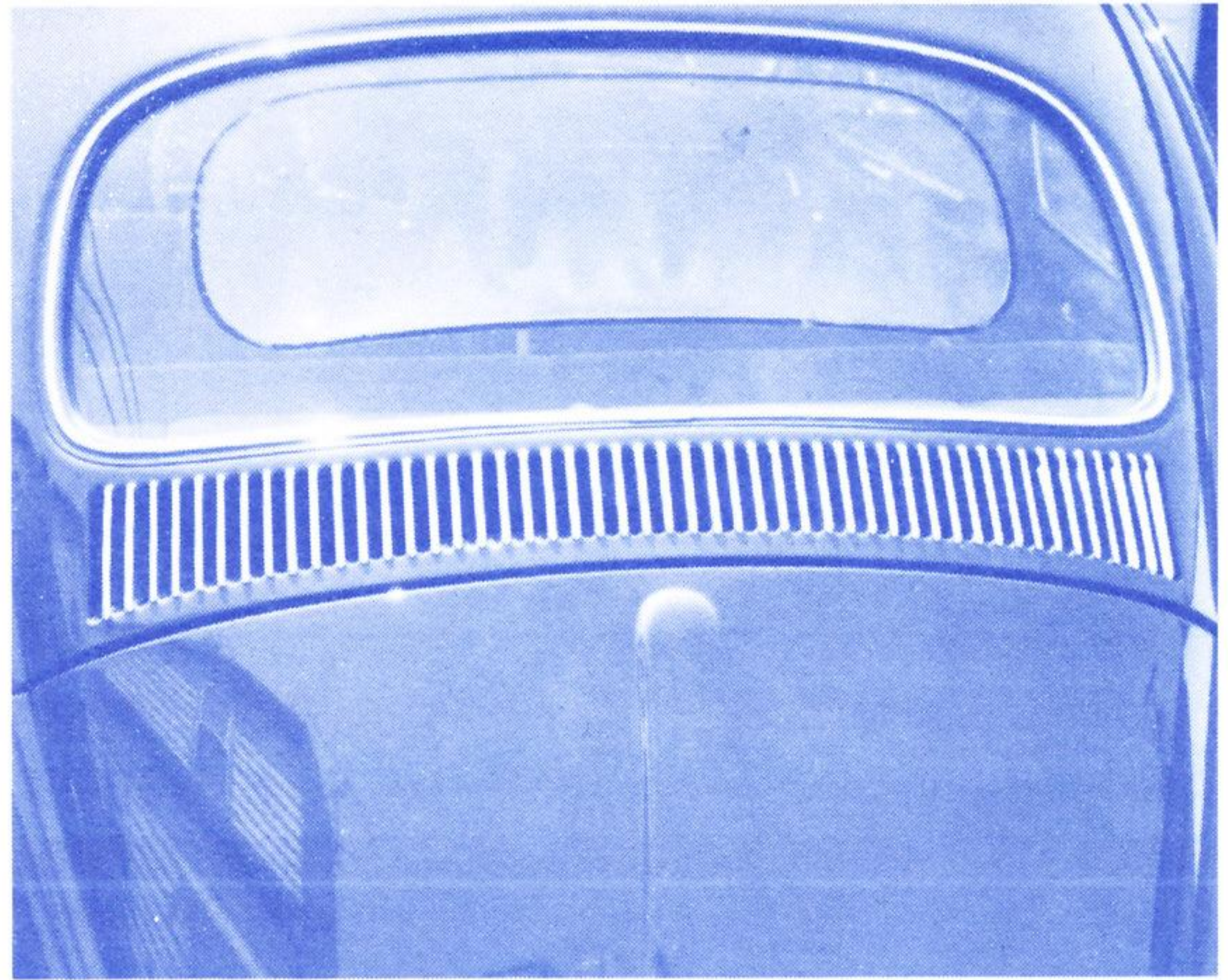

ENGINE COMPARTMENT LOCK

Clever device permits access to engine compartment only when ignition is on. Prohibits opening of lid even when the car is left unlocked. Eliminates frozen locks and fumbling for extra keys. Easy installation, no holes to drill. All parts complete.

No. 276 \$ 5.95 each

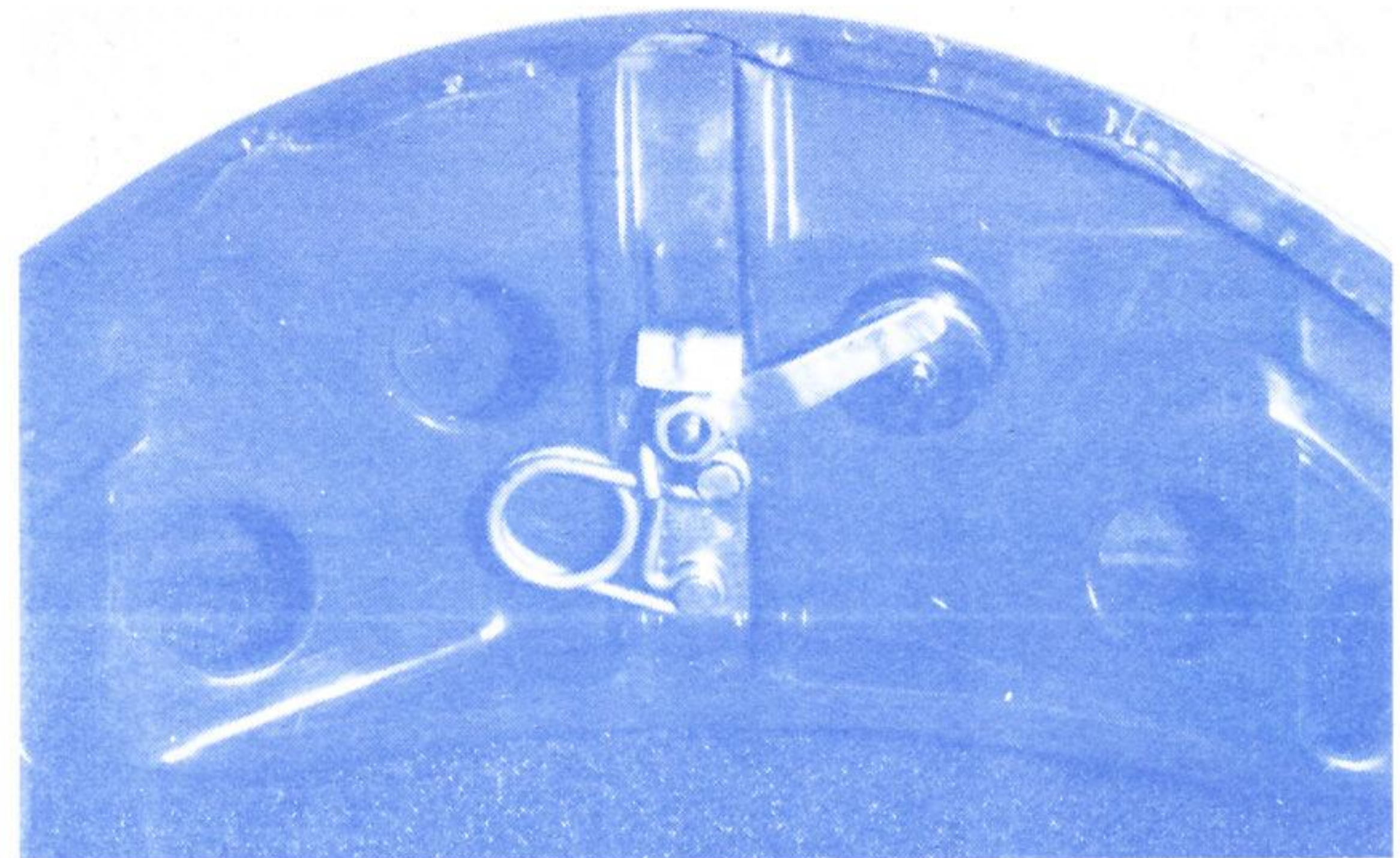

FENDER FLAPS

Protect fenders from flying stones and gravel. Smart looking white fender flaps are reinforced with contrasting metal insignias. Easy to install, no holes to drill.

No. 26 \$ 6.95 per pair



REAR LICENSE PLATE BRACKET

Your license plate will mount perfectly straight and in proper position for maximum amount of light for night driving. Mounts under the license plate light housing using existing bolts. No holes to drill.

No. 64 \$.60 each

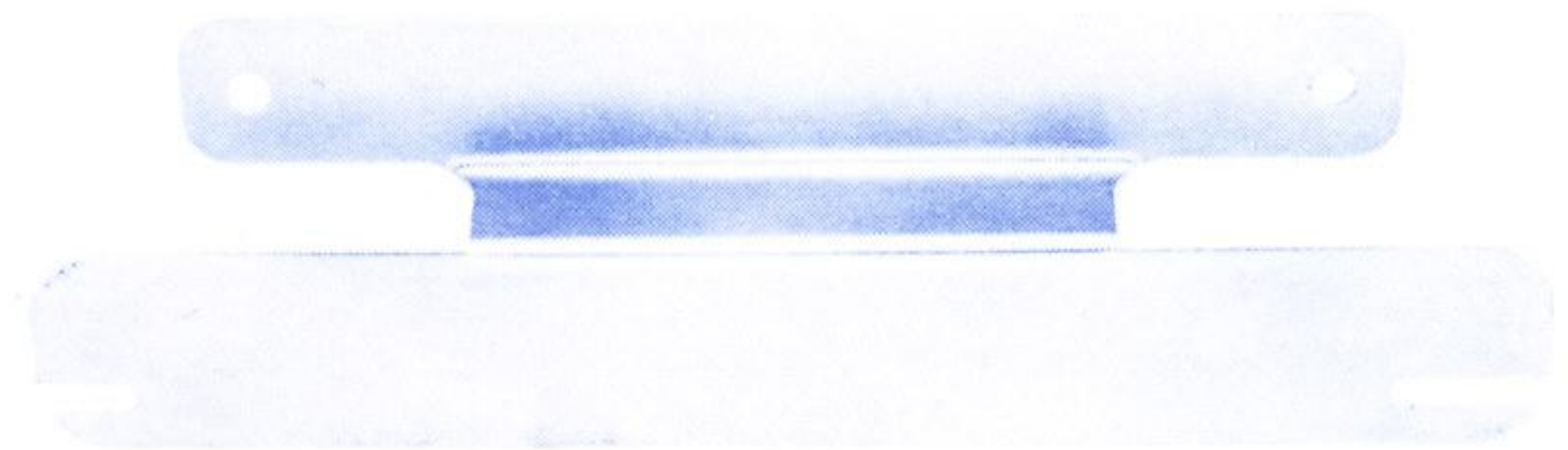

NEW

REPLACEMENT BUMPERS . . . made in Germany

Made by the German supplier of the original equipment. Perfect replacements for all VW 1200 sedans, convertibles. High grade steels and plating throughout. Pre-assembled and complete with face bars, bows and overriders and all necessary hardware.

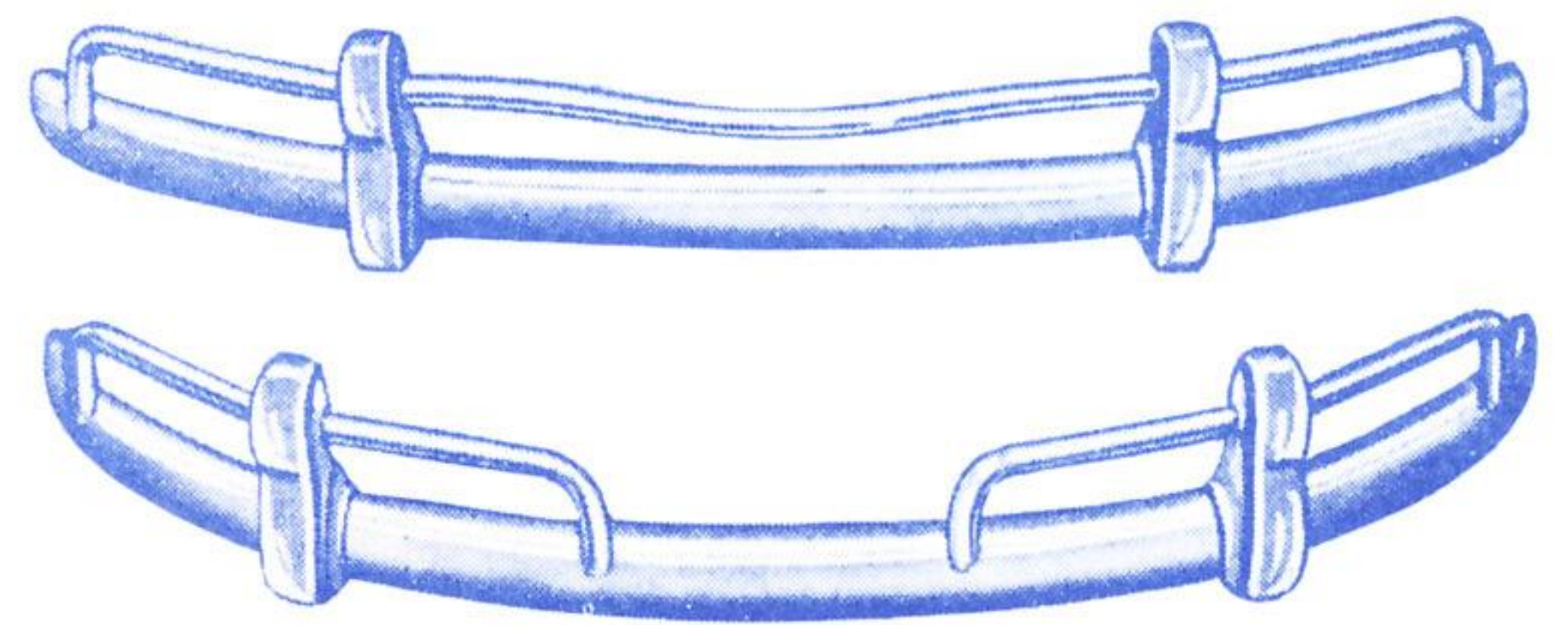

No. 1095	Front bumper complete	\$32.00
No. 1096	Rear bumper complete	36.00

NEW

BUMPER STIFFENERS . . . save your bumpers

Pre-formed, heavy gauge tubular reinforcers fit inside standard Volkswagen bumper, add rigidity and strength to help withstand more punishment. Installation is easy, requires no welding or drilling. All parts protectively plated. Complete kit includes front and rear stiffeners and all installation hardware.

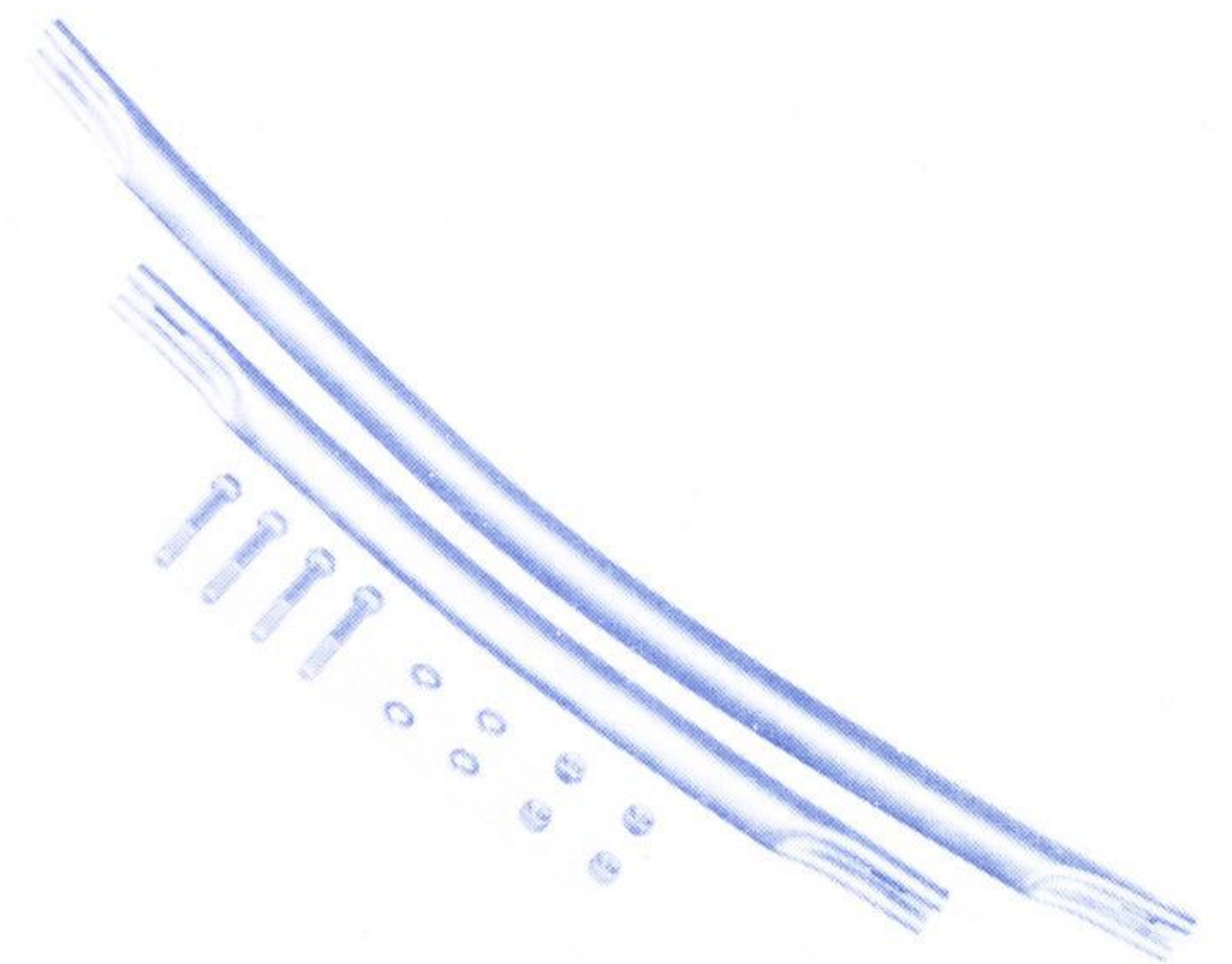

No. 1090	\$ 6.95 per pair
----------	-------------------------

RUBBER BUMPER INSERTS

Prevents unsightly dents on your overriders. Made from 100% live rubber to resist the maximum abuse. Easy installation on each overrider with template supplied. Exceptionally low priced, guaranteed to satisfy. Designed specifically for the Volkswagen bumperette. Specify year when ordering.

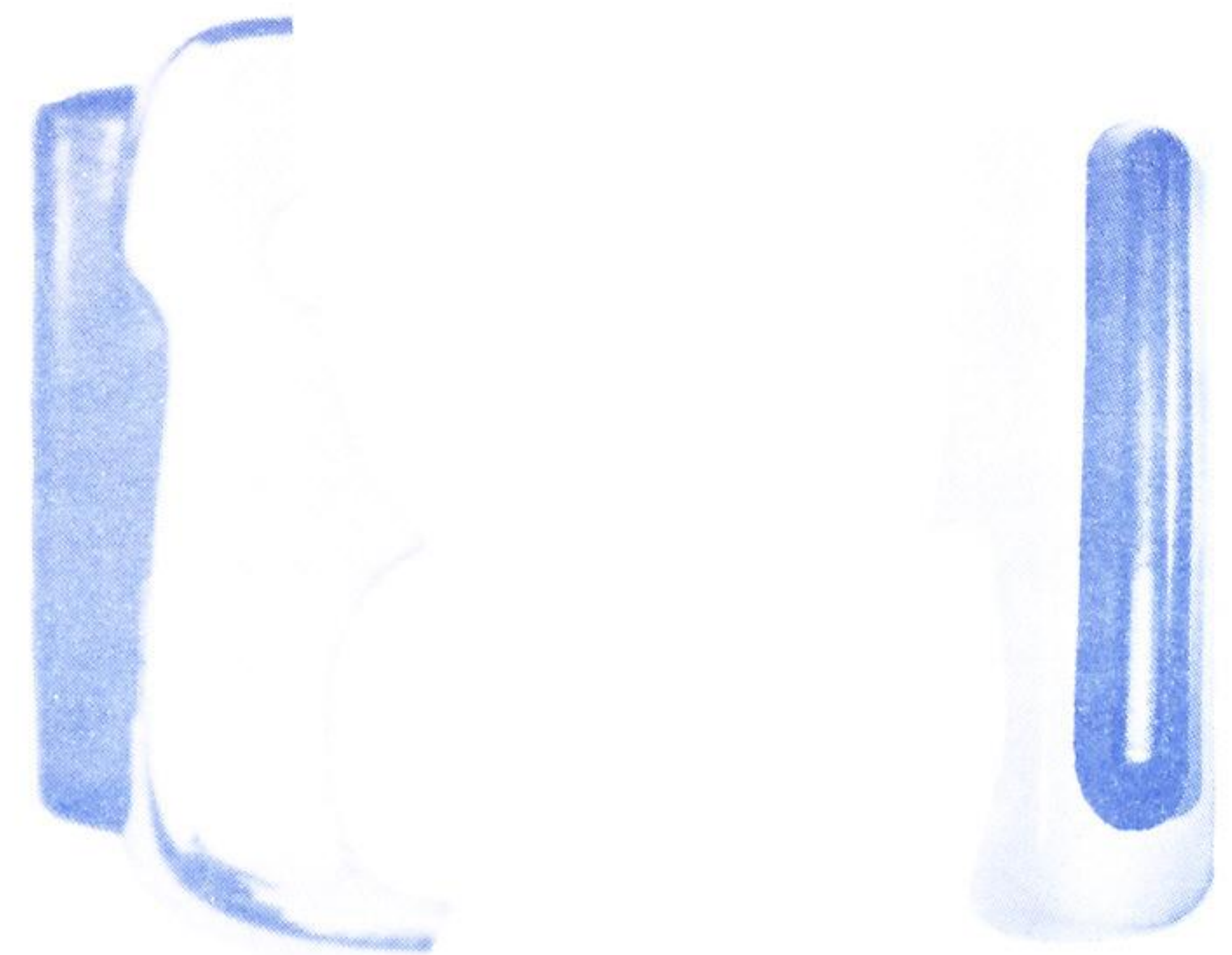

No. 10 Sedans and convertibles to 1960	\$ 4.95 per set of 4
No. 12 Sedans and convertibles 1961 to date	4.95 per set of 4
No. 28 For all transporters	8.95 per set of 4

TRAILER HITCH

Makes a solid connection between the frame and the bumper. A perfect fitting hitch for all VW sedans and transporters. Made from rugged materials. Has the finest features found on any hitch regardless of price.

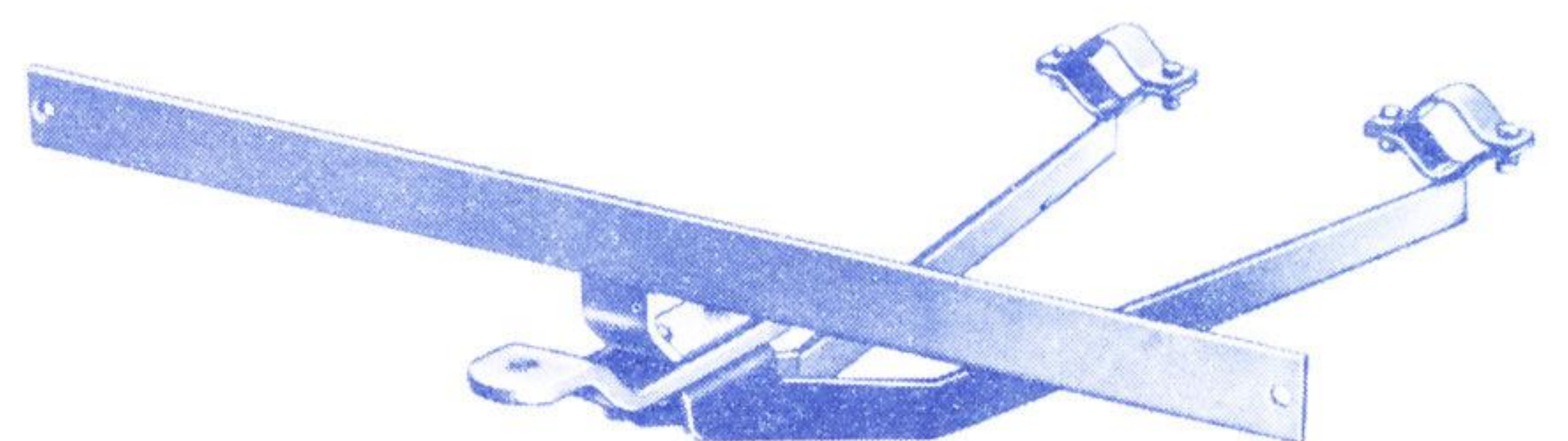

No. 134	All sedans	\$19.95 each
No. 135	All transporters	19.95 each

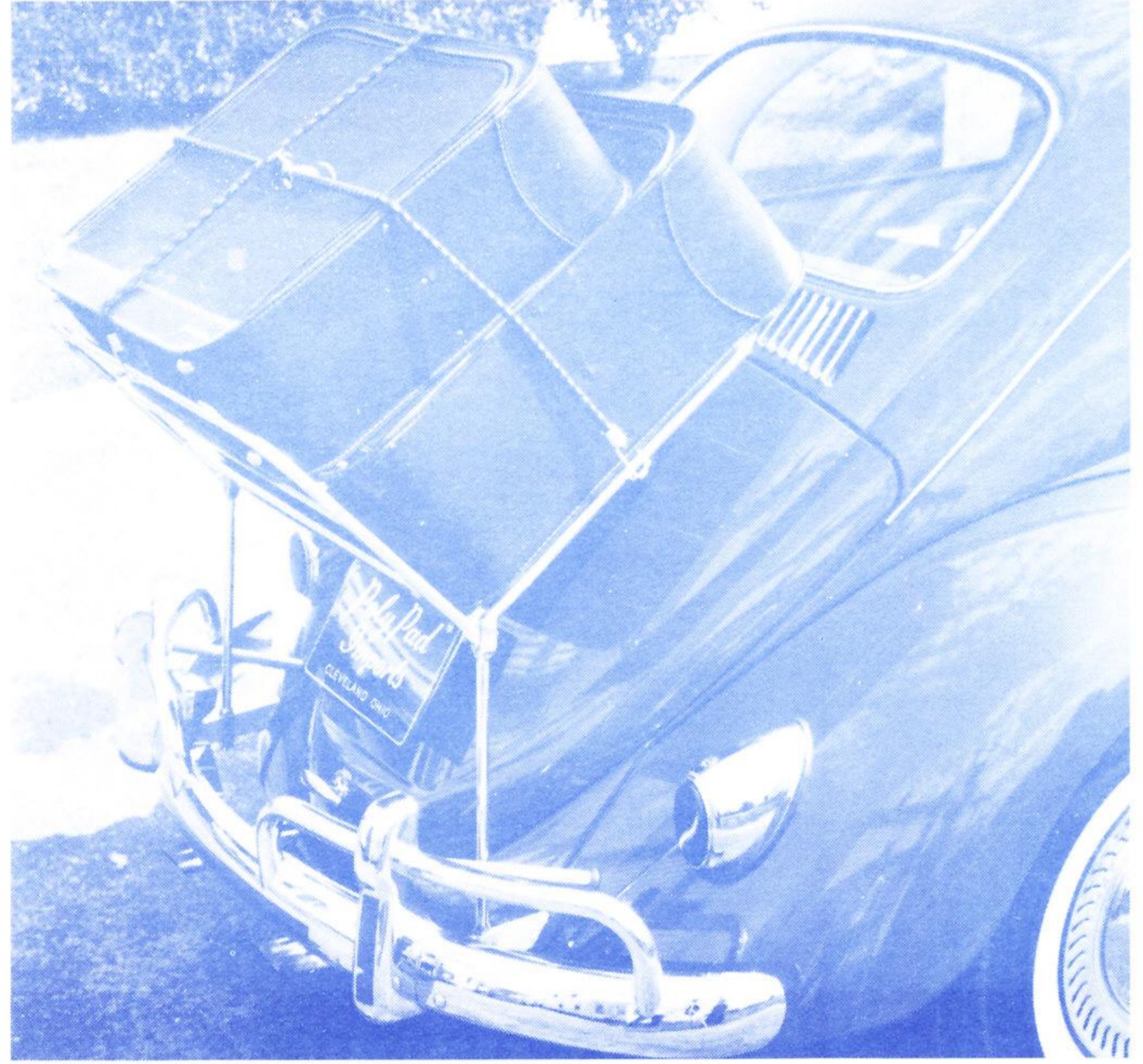

REAR DECK LUGGAGE CARRIER

Mounts over the rear deck lid, and unlike top mounted carrier, does not increase air resistance, permits top speed on trips. Securely attaches to bumper supports and air intake slots with no drilling or alterations. Allows instant access to engine compartment. License plate is always in view. Made from steel tubing, welded construction throughout; will support nearly 200 pounds. Available chrome plated or zinc plated with chrome mounting brackets.

No. CC-1	Chrome plated, for convertibles	\$32.95	each
No. CZ-2	Zinc plated, for convertibles	29.95	each
No. SC-3	Chrome plated, for sedans	39.95	each
No. SZ-4	Zinc plated, for sedans	36.95	each

COVERED LUGGAGE RACK

Exclusive Volkswagen design. This luggage carrier, with over 12 cubic foot capacity, comes complete with waterproof, dustproof, heavy vinyl plastic cover to protect luggage. Cover is attached to a one-piece floor for perfect insulation and support and has zippered side opening for easy loading. Carrier is supported by four specially designed rubber covered brackets which clip to rain gutters. No extra hardware to attach. Room enough to open sunroof. Dimensions 42" x 42" x 11". Will fit all year sedans and sunroofs.

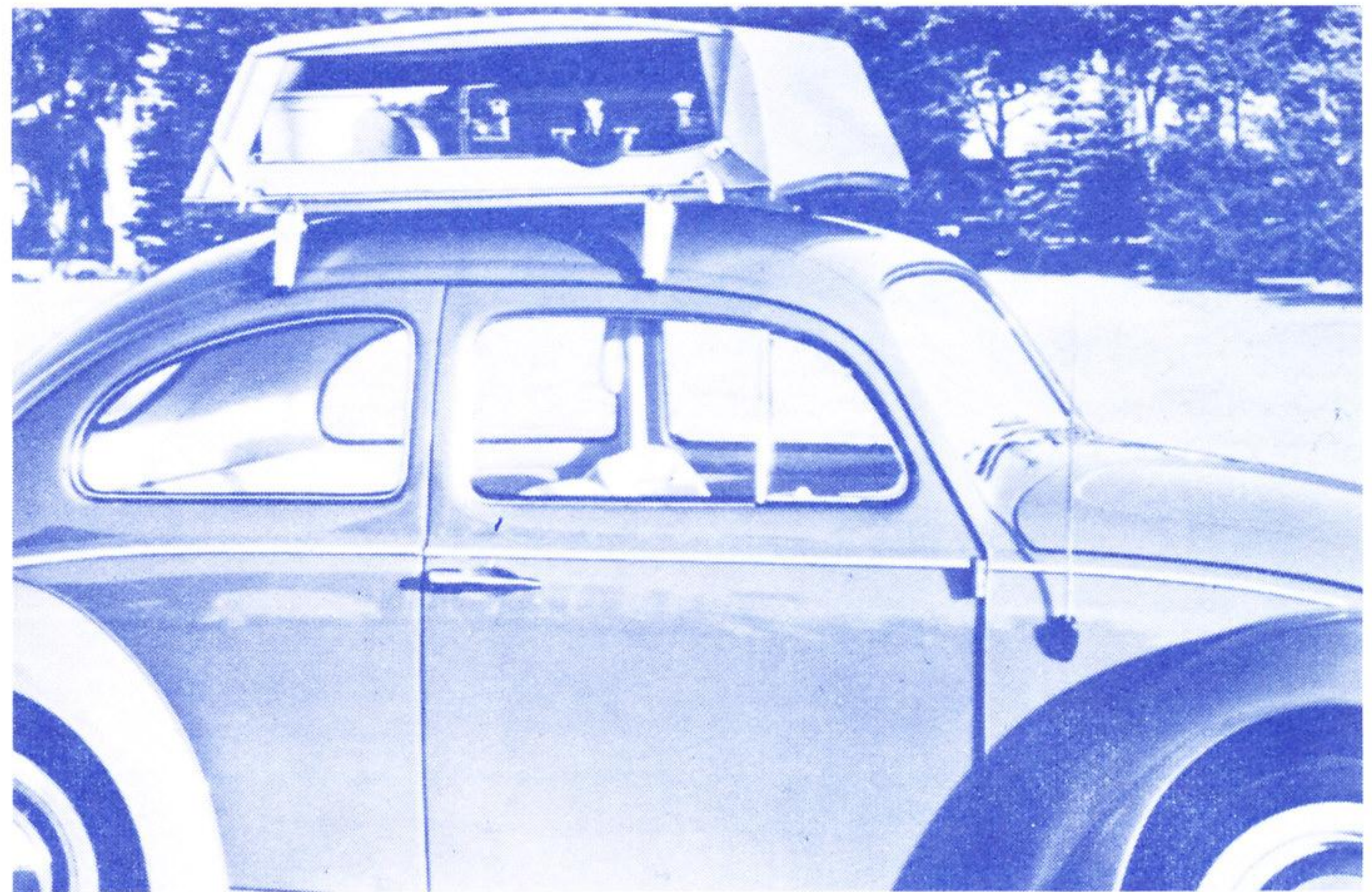

No. 3545 Carrier and Cover **\$36.95** complete

LUGGAGE SPYDER . . . Universal Model

Secure luggage to any carrier with this six cable spyder. Made of fabric-covered live rubber with steel anchoring hooks.

No. 104 **\$ 3.95** each

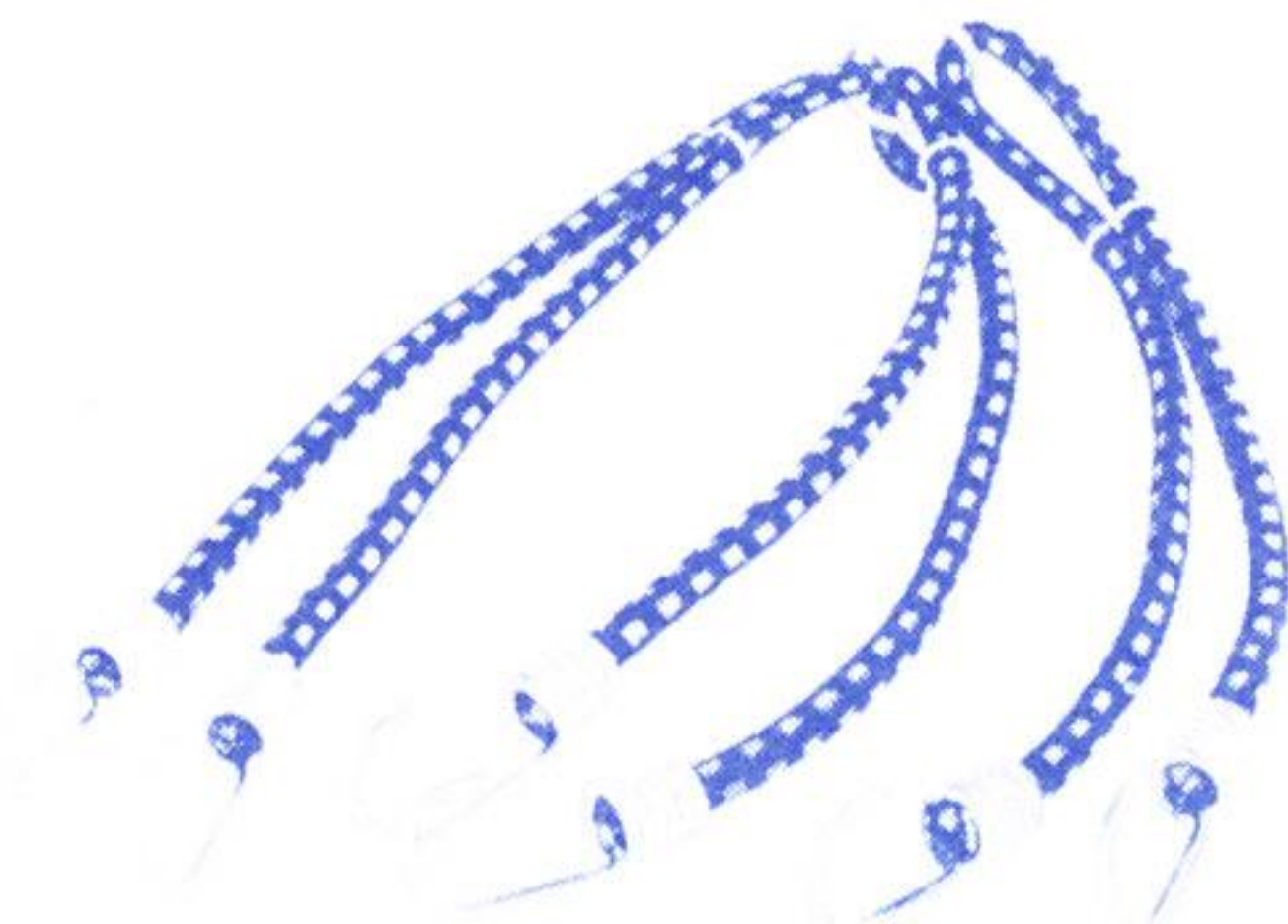

FOR YOUR RIDING COMFORT

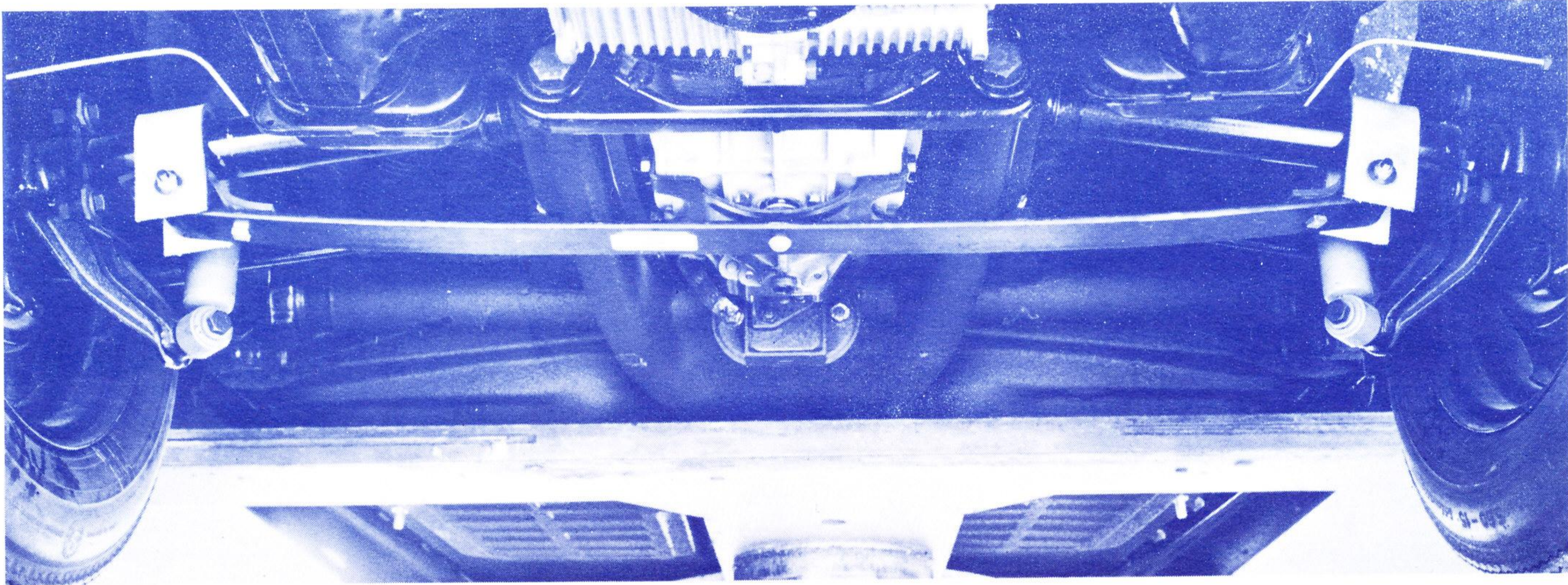

EMPI CAMBER COMPENSATOR

Rear stabilizer designed for Volkswagens. Compensates for unequal rear weight distribution on high speed turns or rough roads, in gusty winds. *Greatly improves stability*, reduces body lean, helps correct over steer. Quickly and easily installed.

- | | | |
|-----------|--|---------------------|
| No. 105A | For sedans, sunroofs, convertibles and Ghias 1961-1965 | \$19.95 each |
| No. 106TA | For transporters, late 1959-1965 | 19.95 each |

BOGE SHOCK ABSORBERS

Heavy duty, German made, for all Volkswagen passenger models. Recommended by the automotive experts for improved stability and safety because they reduce sway and lean in high speed turns. Piston is 5 mm larger than stock VW units and BOGE shocks last longer. For top performance in gymkhanas, slaloms, and other competitions, as well as safer, more comfortable riding, install BOGE shocks on your VW today.

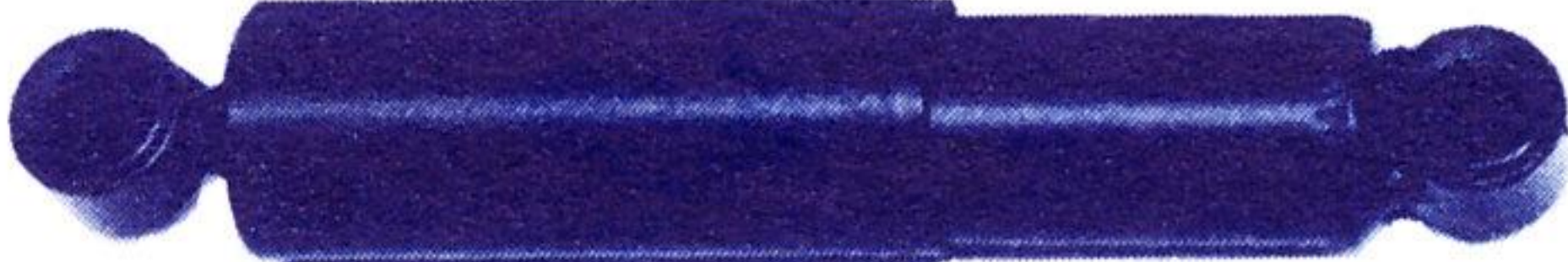

- | | |
|-----------------------|---------------------|
| No. 8400 Front shocks | \$10.95 each |
| No. 8500 Rear shocks | 10.95 each |

BOGE STEERING DAMPER

A precision manufactured part for improved handling on all late model VW's. Ideal replacement. Quality German made. Fits all 1961 and later VW passenger cars.



- | | |
|----------|---------------------|
| No. 8700 | \$ 7.75 each |
|----------|---------------------|

AXLE BOOT

Keep dirt out by replacing worn or torn rear axle boot. Specially compounded for extra long wear. Will fit all year VW's. Complete with clamps and screws; easy installation.

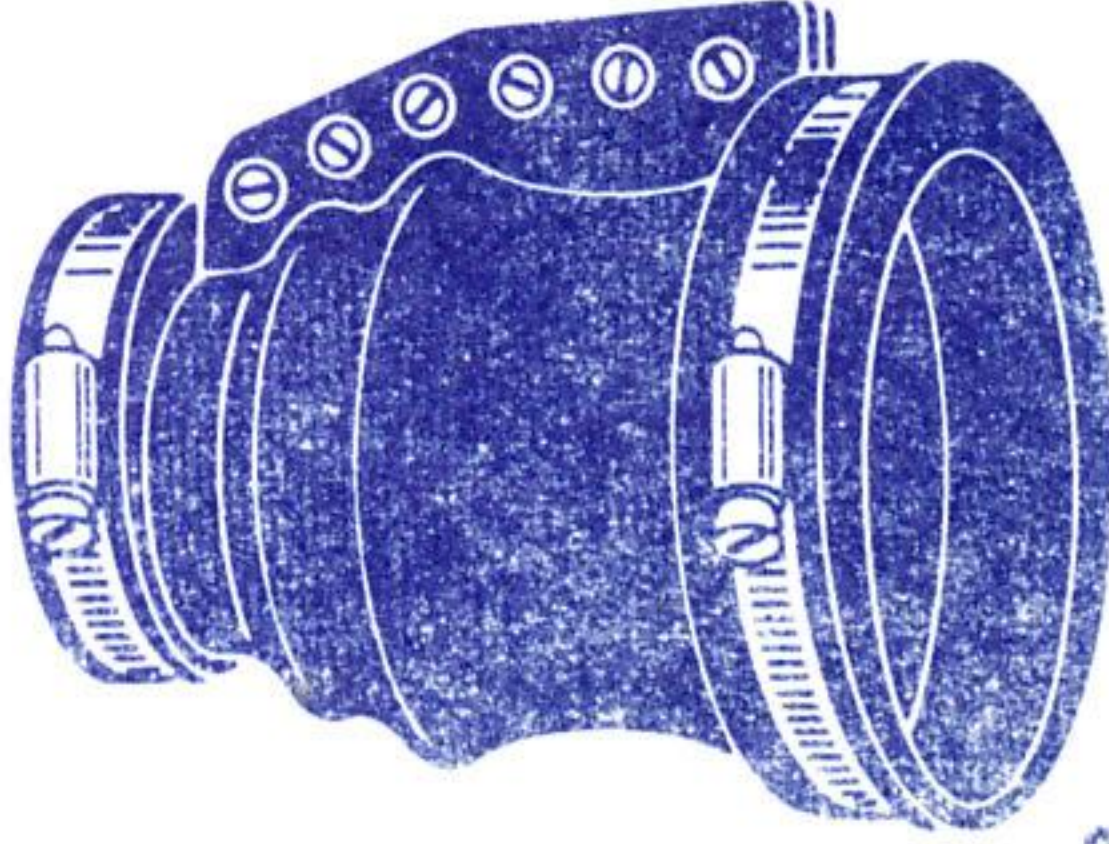

- | | |
|--------|---------------------|
| No. 27 | \$ 2.95 each |
|--------|---------------------|

MUFFLERS

Perfect fit for all year Volkswagen sedans. Our mufflers exceed weight of original equipment, are guaranteed to give you the maximum service obtainable. Extra heavy duty parts and welding throughout. Specify year and model when ordering.

No. 5560 For 36 h.p. engine \$ 9.95 each
No. 6064 For 40 h.p. engine 9.95 each

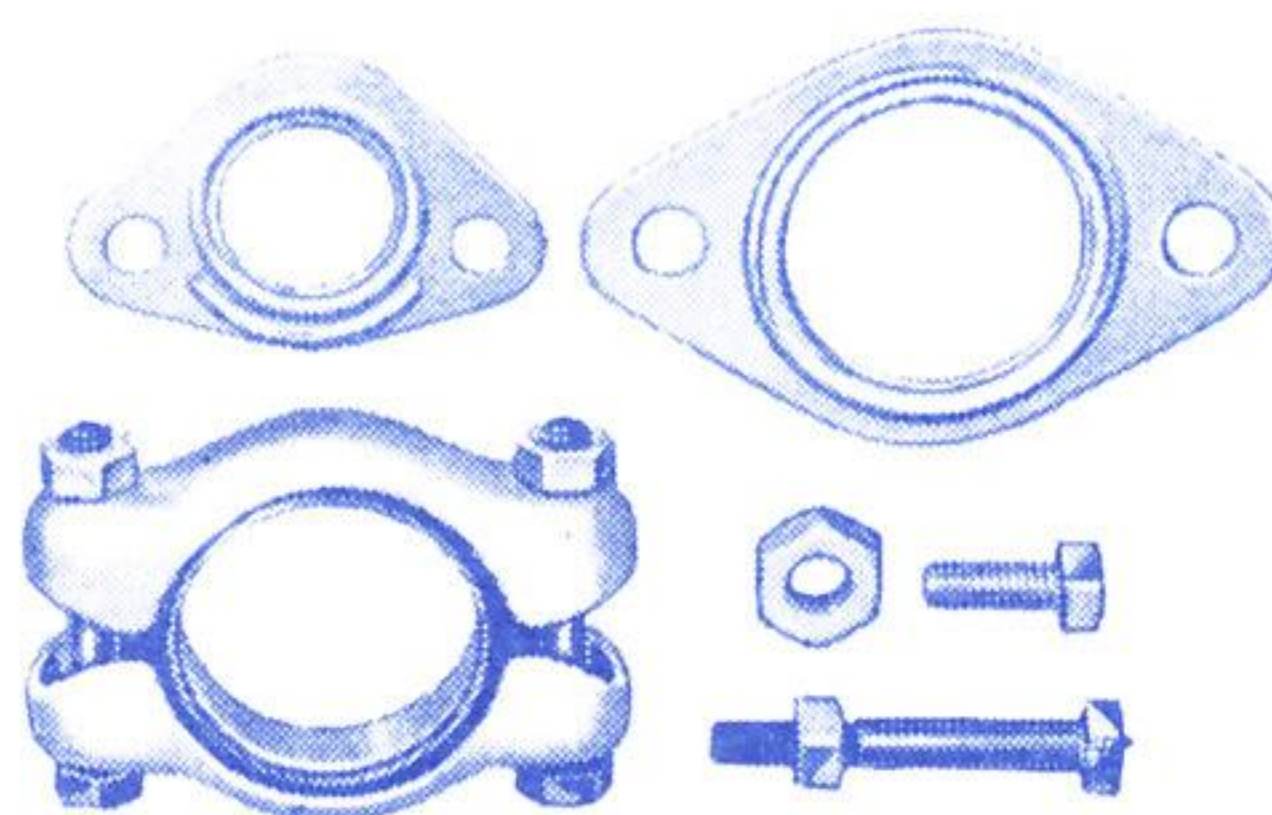
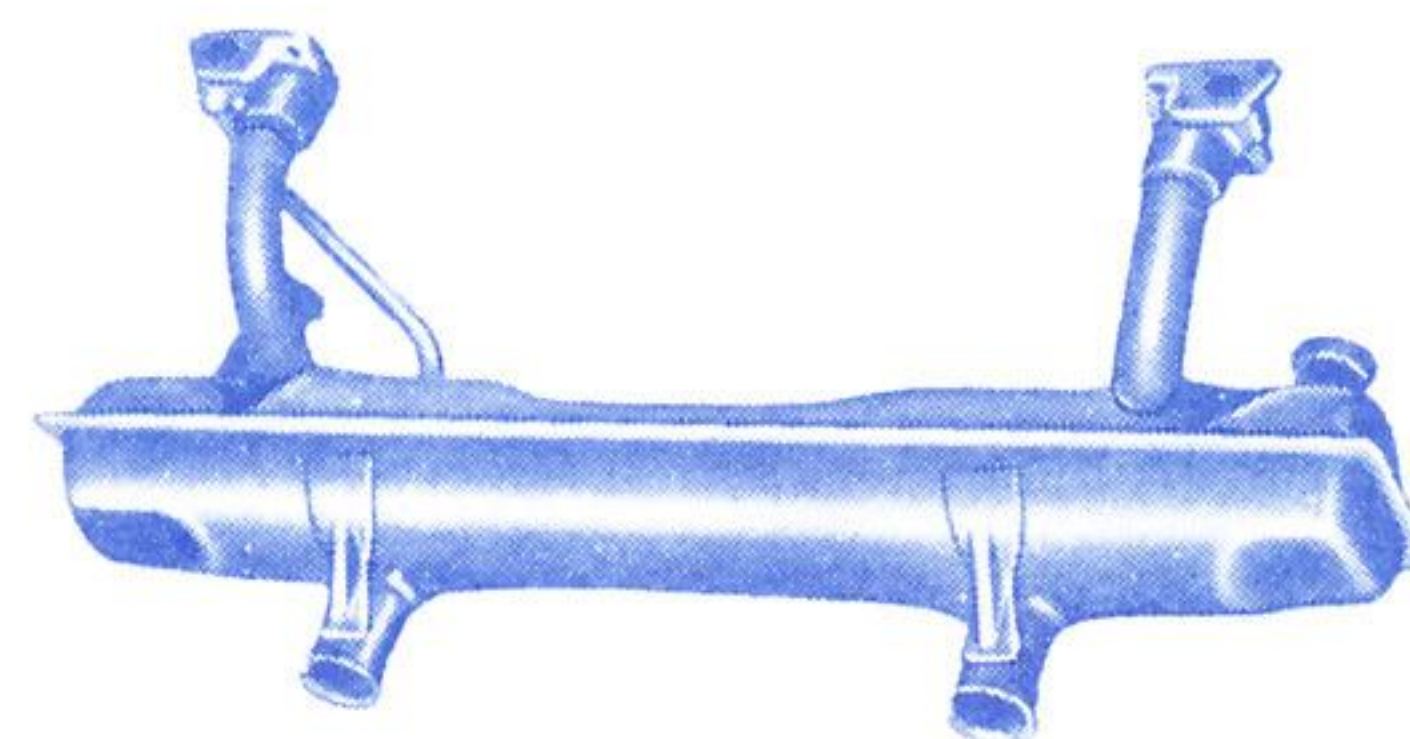
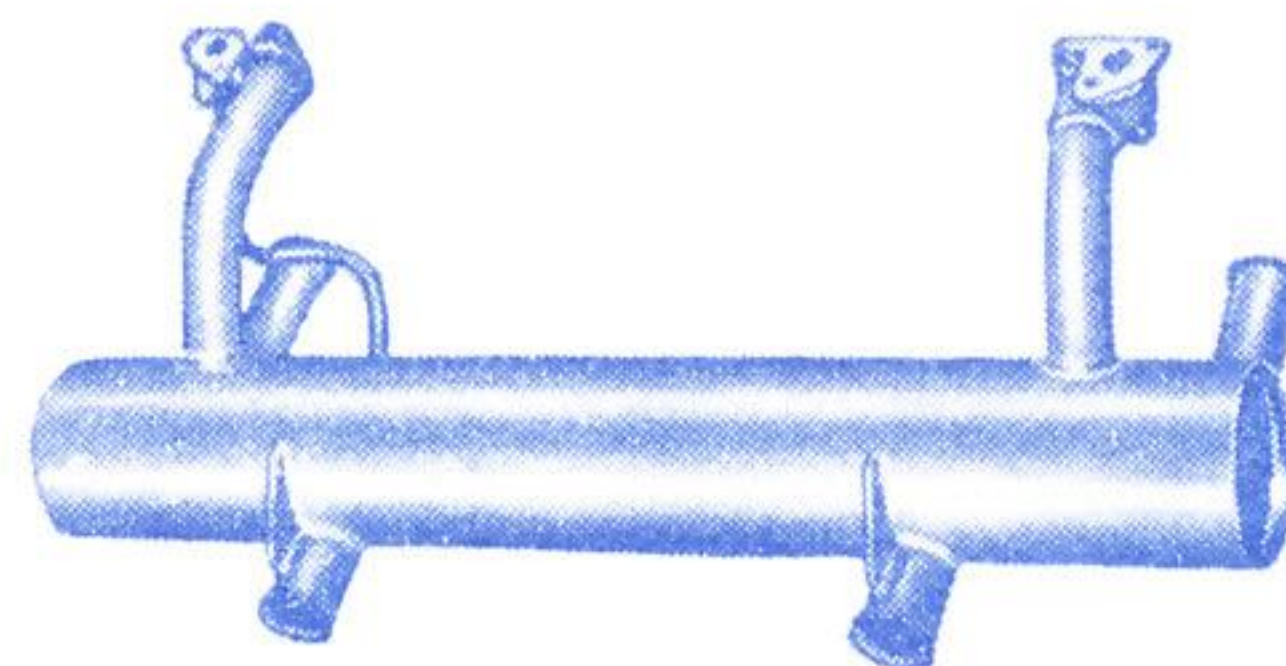

CONNECTOR KIT

Complete, specify year.

No. 5500 \$ 1.95 each

MUFFLER PIPES

Perfect replacement for original equipment. Fiberglass packed with sparkling chrome-plated exterior. For all year Volkswagens

No. 23 \$ 1.80 each



CONNECTOR PIPES

Fit between muffler outlet and junction box to replace burnt-out pipes.

No. 24 \$.75 each

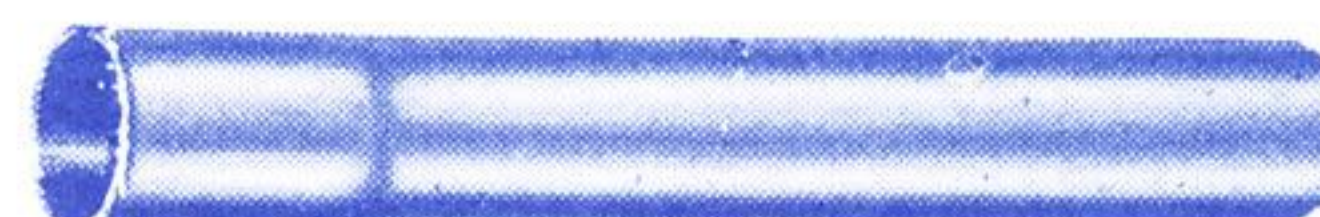

TAPER TIPS

... for all Volkswagen and Ghia mufflers

Cut exhaust back pressure by 50%. Boost horsepower and gas mileage by 5%. Change bothersome exhaust whistle to a low pleasant sound. Sharpen the appearance of your Volkswagen. Beautifully chrome-plated by exclusive Tri-Chrome process for long-lasting mirror finish. Fiberglass packed. *Easy to install without special tools.*

No. TRT-1 \$12.95 per pair



TAIL PIPE TRIM

Handsome accessory to dress up your car. Grilled model, or solid model with Day-Glo reflective tape. Easy installation - simply slip over the tail pipes and springs lock the trim in place.

No. 179 Grilled Trim \$ 4.75 each
No. 182 Reflector Trim 4.95 each

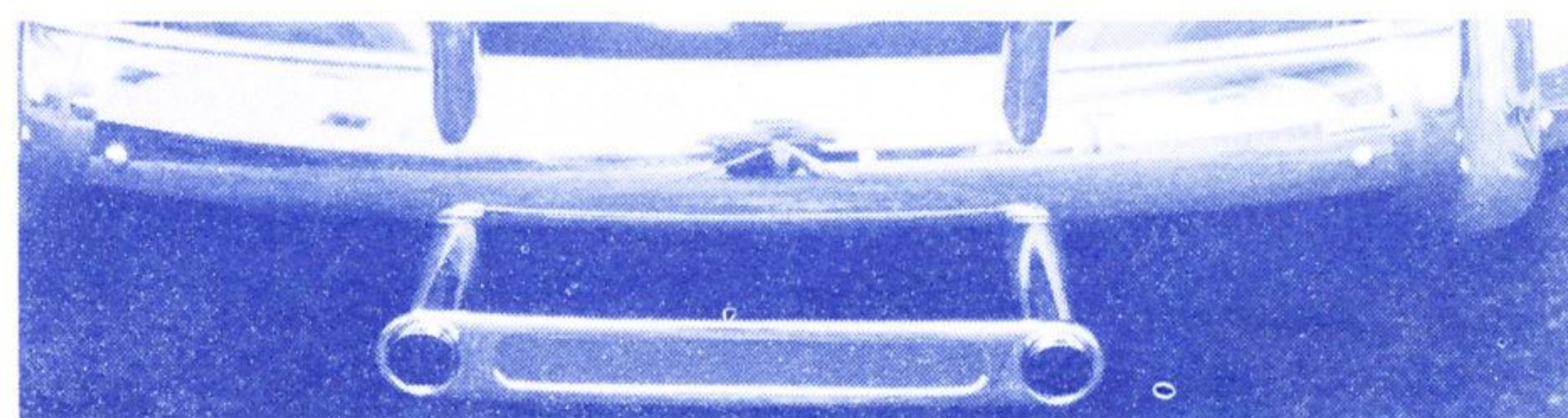
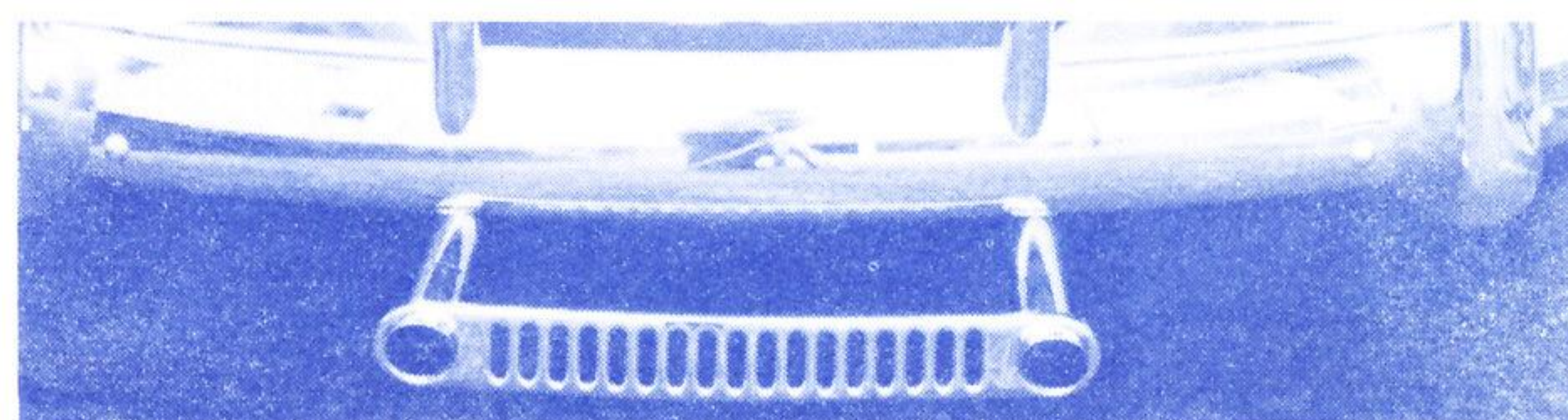

811 PROSPECT AVENUE

POLY PAD IMPORTS

CLEVELAND, OHIO 44115

Accessories for the Volkswagen Owner

NEOPRENE VALVE COVER GASKETS

The perfect answer for the valve cover gasket problem. Heavy-duty neoprene gaskets can be used over and over again without losing their sealing ability. Easy to handle, easy to install and remove.

No. 3960 For 36 h.p. engine \$.80 per pair
 No. 3940 For 40 h.p. engine .80 per pair

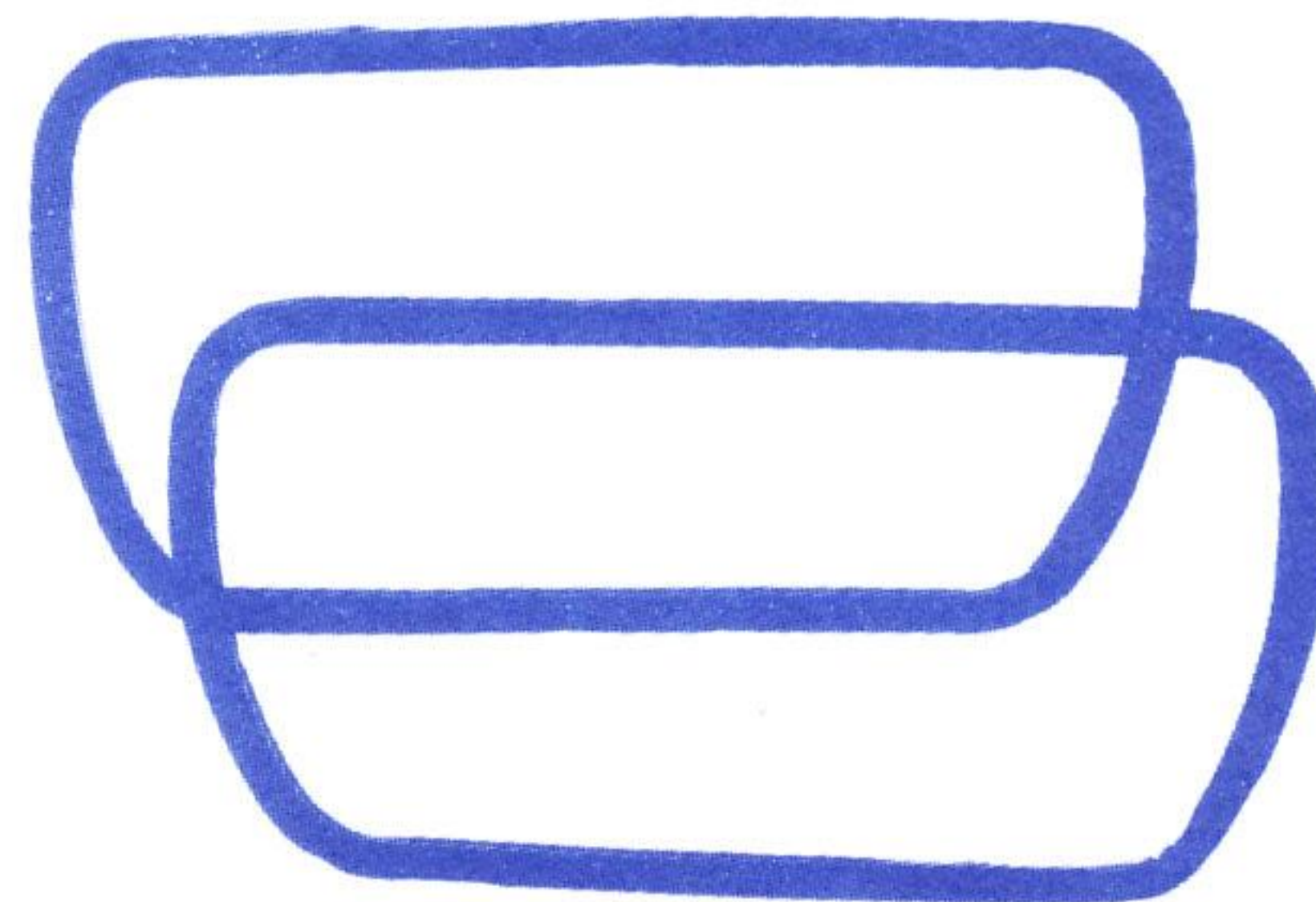

CARBURETOR JET HEATER

Thermo Carb Control pre-heats fuel and air mixture and de-ices carburetor orifice. Smooths idling, eliminates power loss due to carburetor icing. Choking is held to a minimum or eliminated. Used year 'round for better economy. Installation is easy: unit replaces volume screw in carburetor, and electrical connection is made at voltage regulator.

No. 60 \$ 5.95 each



FUEL FILTER

Trouble-free, in-line gas filter with micro-bronze element, the only type of element that can be cleaned and re-used. Designed to make your Volkswagen run better. Permanent bronze element won't chip, flake or swell, can't get clogged by fuel-line moisture. Filters out water, allows only pure fuel to get through. Prevents flooding and vapor lock. Fits all Volkswagens with flexible gas lines.

No. 103 In-line (1961 on) \$ 3.50 each

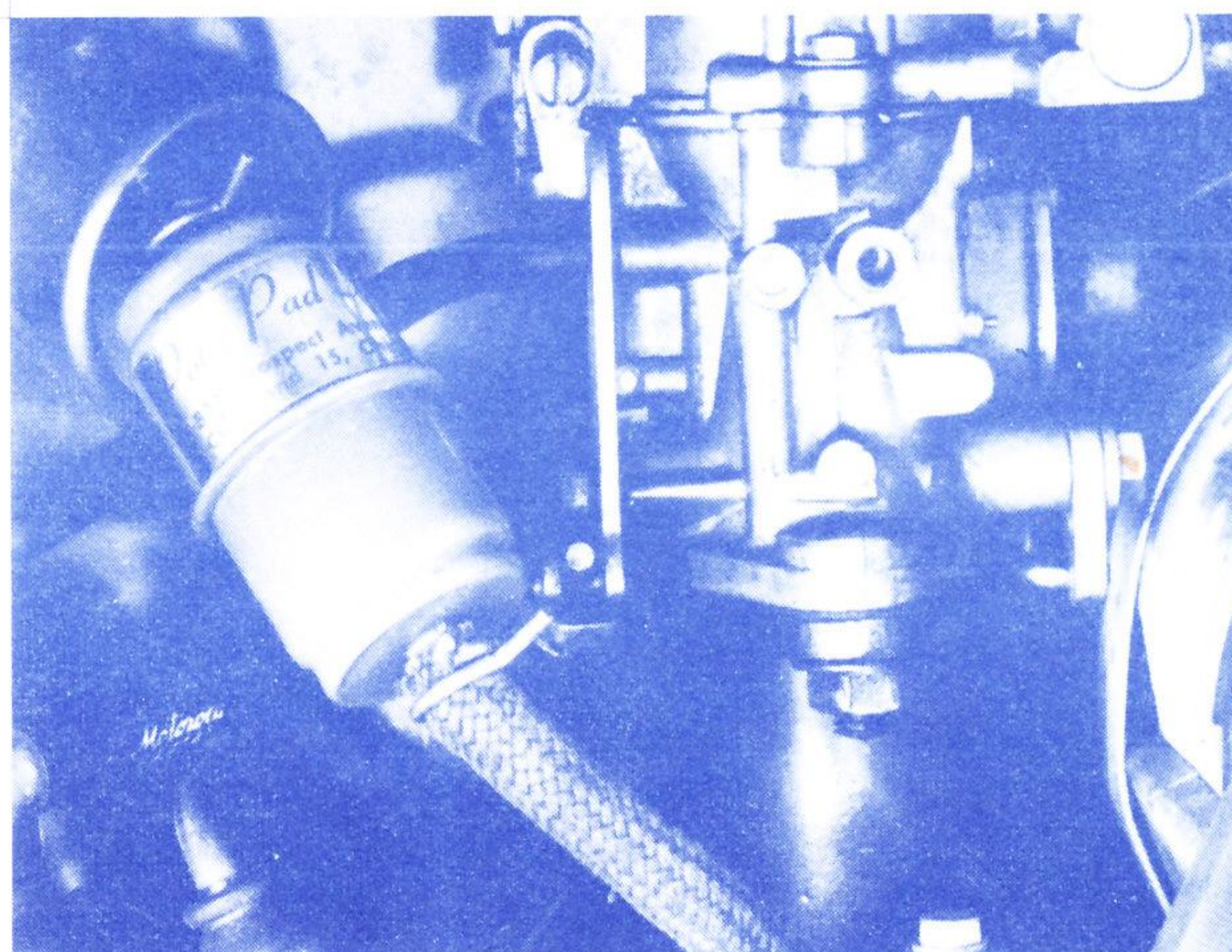

NEW

MAGNETIC OIL PAN DRAIN PLUG

. . . prevents unnecessary engine wear!

Trap stray particles of steel. Strong, permanent magnetic plug "draws" bits of steel from the oil. These particles are usually found in new engines and in engines that have been recently worked on, but normal engine wear can produce them too. Install in place of conventional oil drain plug. Fits all VW's from 1960 to date.

No. 1000 \$ 1.50 each



NEW AIR HORN, MADE IN ITALY . . .

it's safer when they know you're there!

Electrically operated air horn produces a confident, penetrating blast with a range of 1 mile. Twin trumpets produce a distinctive tone. Chrome plated on brass. Made for side cowl mounting. Compressor is compact, mounts in small space under the hood. Connection is made to existing horn button wiring. Includes selector switch to permit instant switching back to stock horn. Complete with all hardware and necessary parts. For all 6-volt cars.

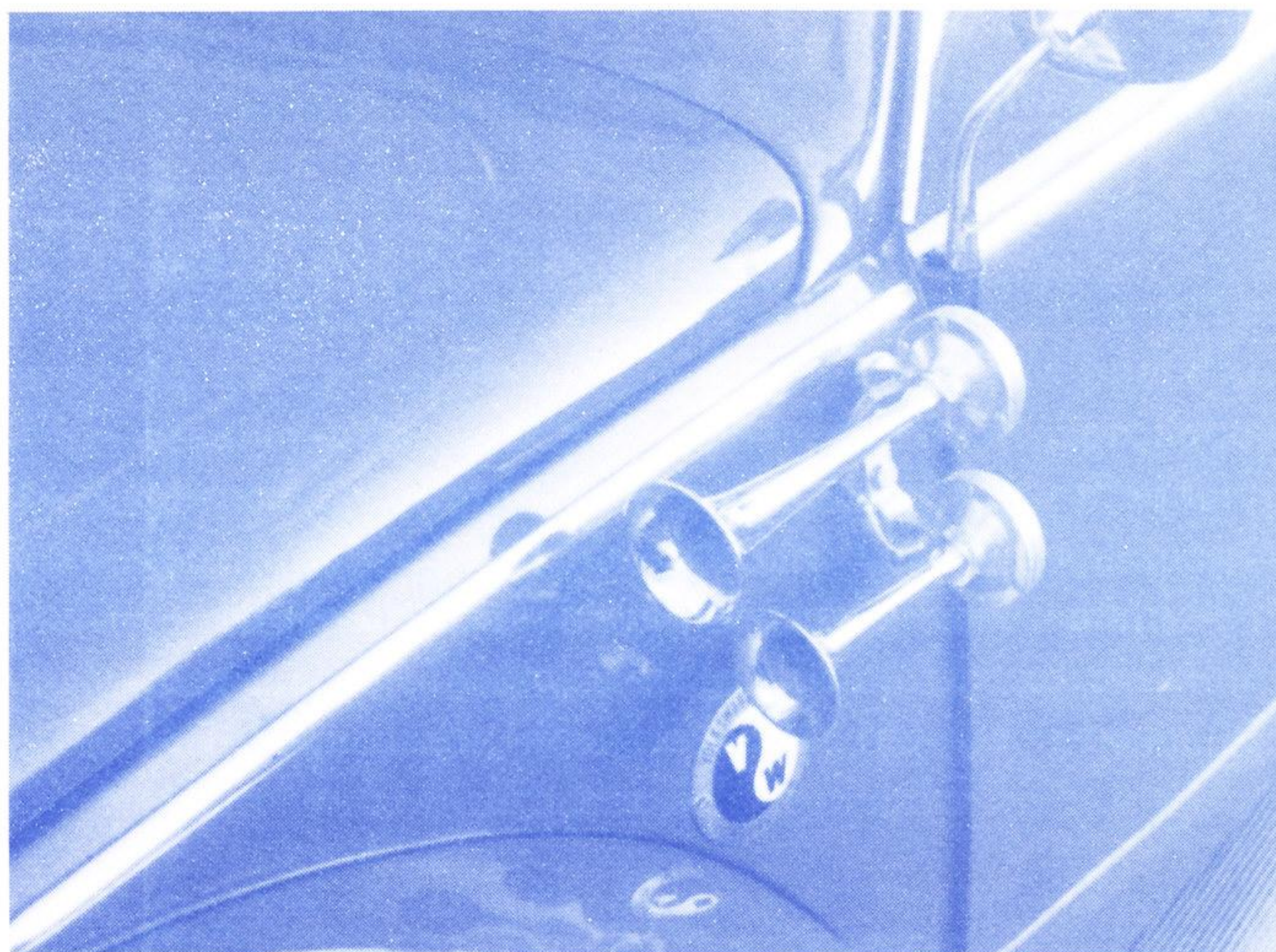

No. 1132

\$39.00 complete

AMBER SIGNAL LENSES

Amber colored lenses are much easier to distinguish than others. Give your car the *continental* look and signal turns more *safely* with genuine, internationally approved lenses for late model Volkswagen sedans and transporters. Amber front signal lens to fit all VW sedans, 1958 to early 1964. Rear signal lens, complete with chrome rim, gasket, two screws and washers, has amber colored turn signal section, tail and stop light section standard red. Transporter front signal lens in amber, complete with screws and washers. Transporter tail light lens has top amber section, balance in red; complete with screws and washers. *Specify right or left side when ordering.* Perfect fit for all *late* models.

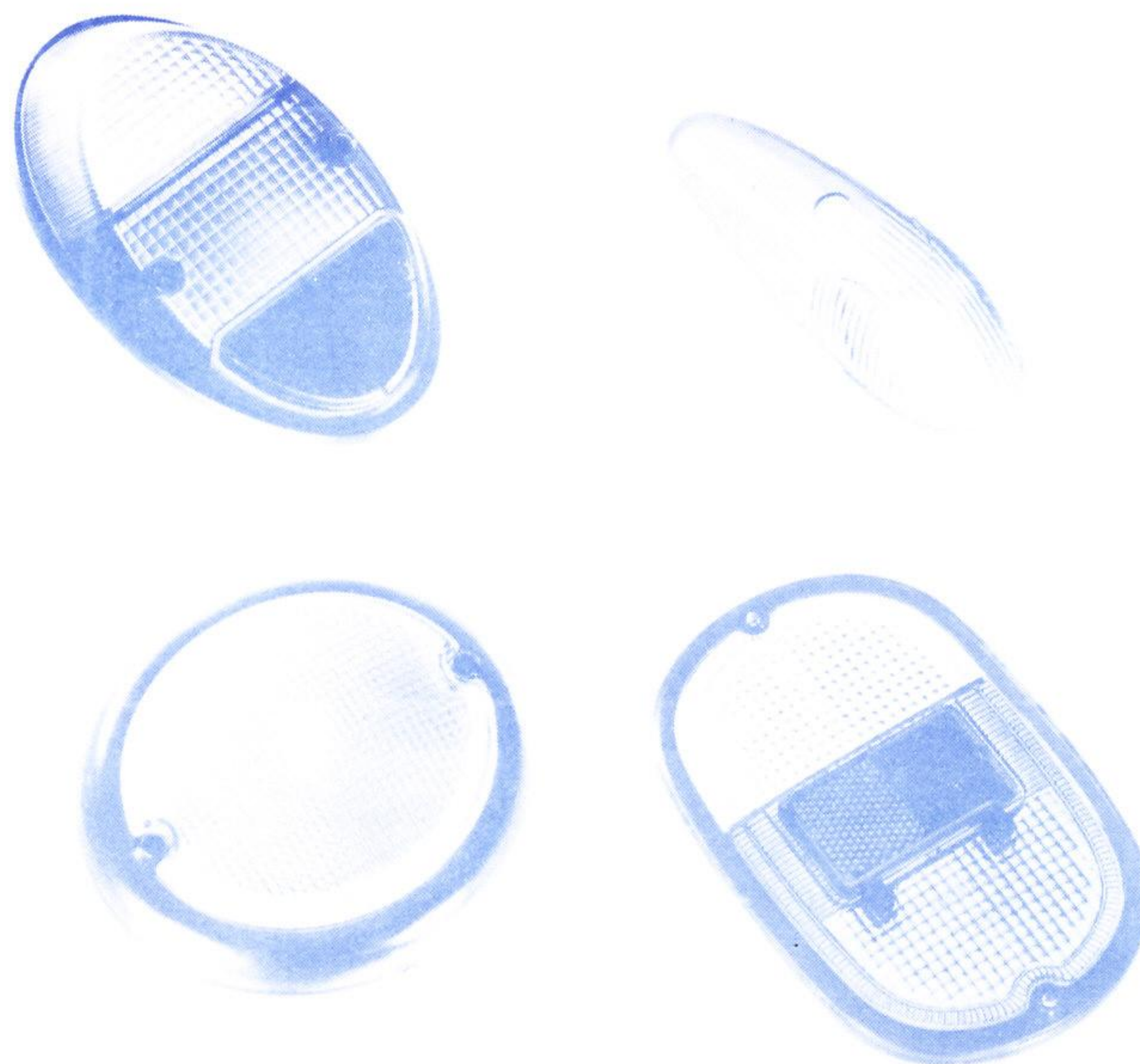

- | | | | |
|-------------|-------------------|----------------|------|
| No. SRBBL70 | Transporter rear | \$ 3.75 | each |
| No. K22639 | Transporter front | 2.45 | each |
| No. 922 | Sedan front | .95 | each |
| No. 950 | Sedan rear | 4.70 | each |

UTILITY LIGHT

Invent your own uses for this one! Originally made as an under-dash map light, it doubles nicely as an engine or luggage compartment light. Built-in switch. Chrome plated. Pre-drilled for easy mounting. Bulb included. (Specify 6 or 12 volt).

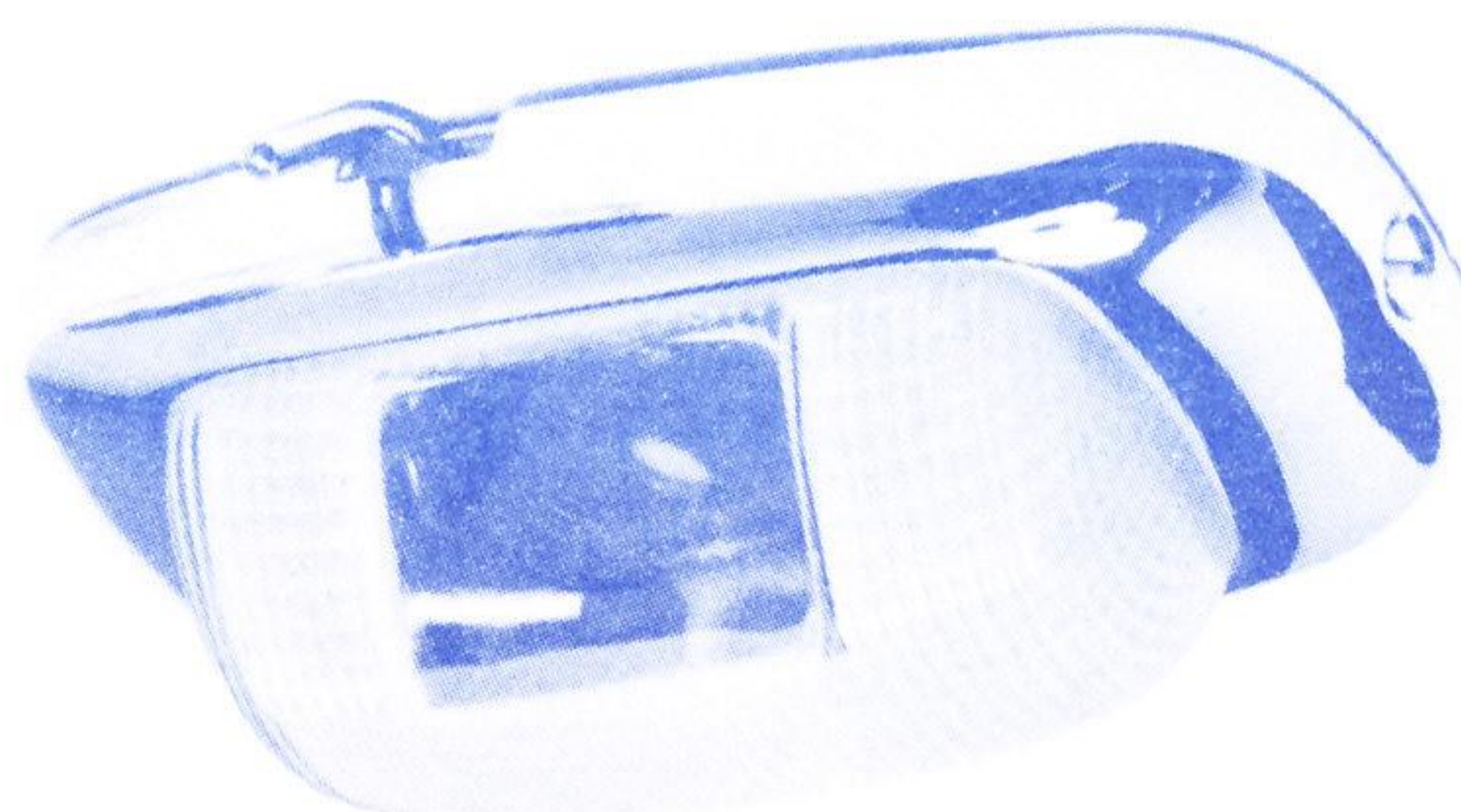

No. 14

\$ 2.25 each

HAND SPOTLIGHT

Popular with motorists for years! Multi-purpose light is handy for spotting addresses, or trouble-shooting around the car. Ample cord is furnished to reach any part of the car. Lamp is a sealed beam unit of 40,000 candle power. Plugs into cigarette lighter. Snap-out support holds spotlight in horizontal position and a hook on top permits hanging. Unit is fully chrome-plated. For any 6-volt car.

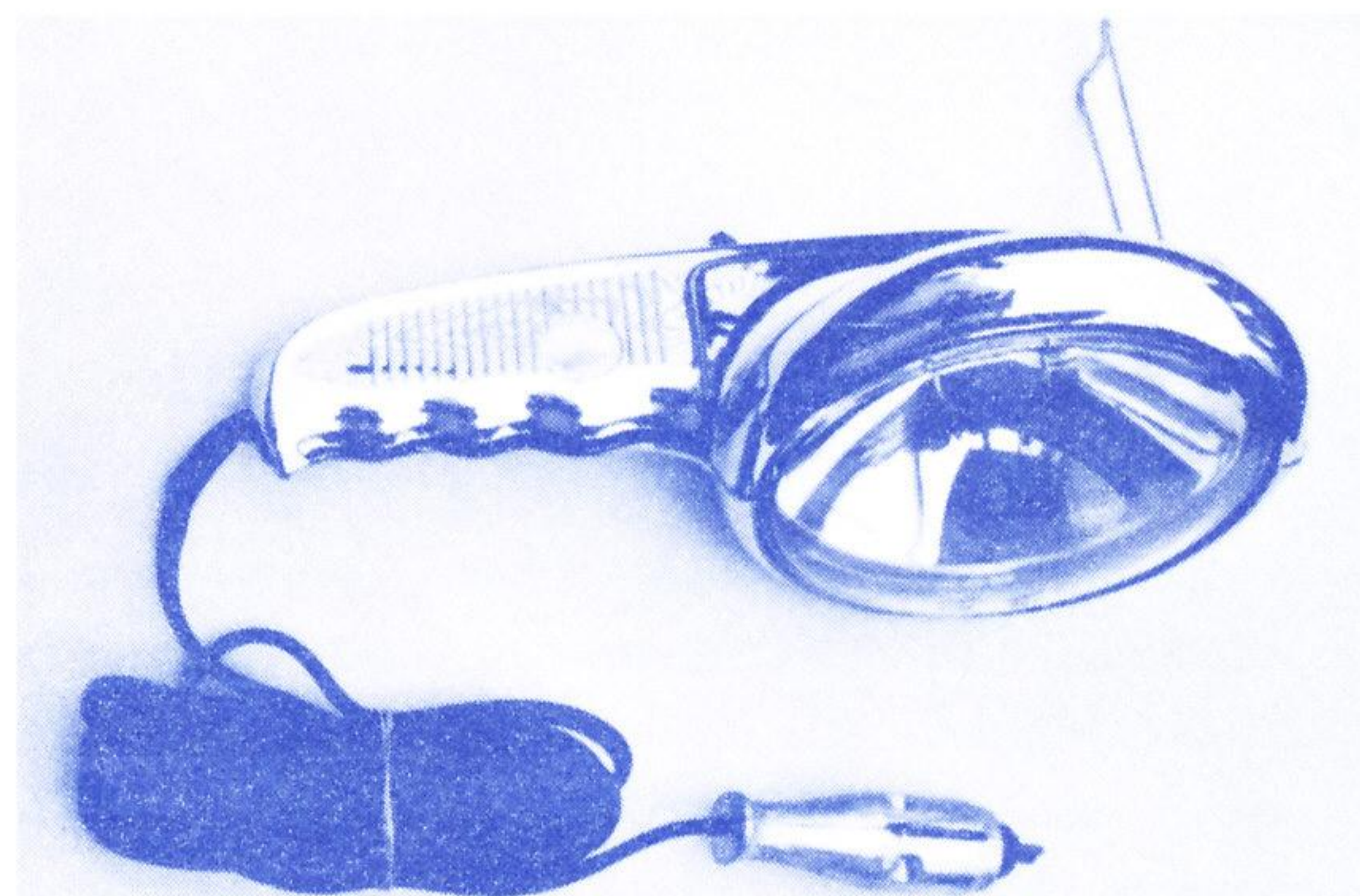

No. F 3070

\$ 7.95 each

811 PROSPECT AVENUE

POLY PAD IMPORTS

CLEVELAND, OHIO 44115

Accessories for the Volkswagen Owner

LIGHTS!

NEW JOKON BACK-UP LIGHT

Brilliant new idea in back-up lights! Makes use of dead space between license plate and the light above it, where it is not susceptible to damage. JOKON back-up light installs easily to license plate light housing and projects strong light to the rear without blocking illumination of the license plate. Automatically actuated from reverse gear. Complete installation kit, with actuator supplied.

No. 260 Single lens unit/for all sedans,
convertibles through 1963 \$ 9.95 complete

No. 261 Twin lens unit/for all sedans,
convertibles 1964-65 12.95 complete



BACK-UP LIGHT

Provides excellent lighting for backing up. A compact unit made for the Volkswagen, conveniently mounts between bumper and the bow. Complete kit contains automatic actuator from reverse, all hardware, quick-connect wiring, complete instructions. An easy installation.

No. 13 For all Volkswagens \$ 9.50 each



BACK-UP LIGHT FOR TRANSPORTERS

Chrome plated, body mount back-up light. Specially suited to the transporter. Mounts on left or right side. Each light complete with clear lens, 6-volt bulb, all fittings and sealing gasket. Use two for better illumination.

No. 491 \$ 1.95 each

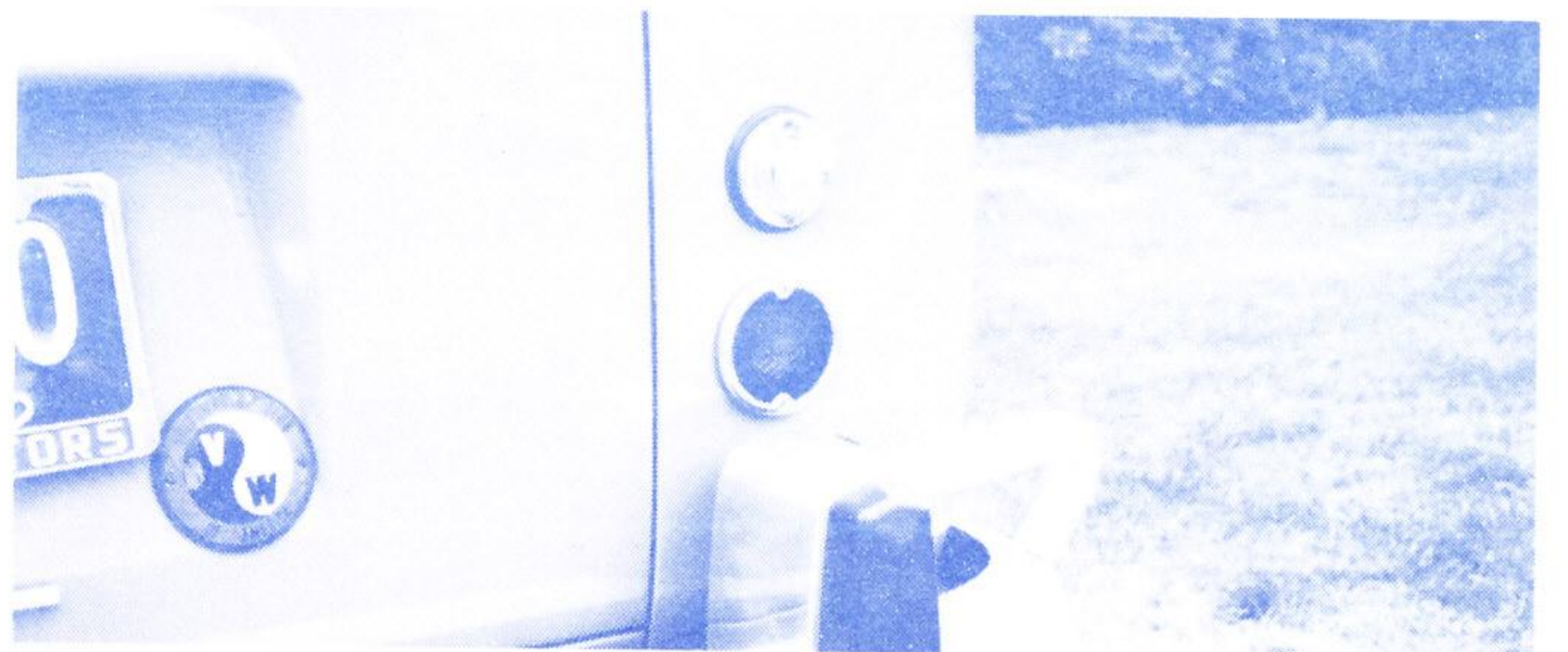

NEW "SEE-THRU" FOG LIGHT

Assured safety for rallies, night, mountain driving. Bulb shield projects wide horizontal beam and prevents wasted vertical spread. Highly popular with European drivers for years. German crafted, precision made. Measurements: 6" wide, 3½" high. Adjustable swivel base. Complete with bracket and bulb. Fits all VW sedans, sunroofs.

No. 9900 One fog light \$15.95 each

No. 9901 In-dash switch and wire
complete for 2 lights 1.25 each

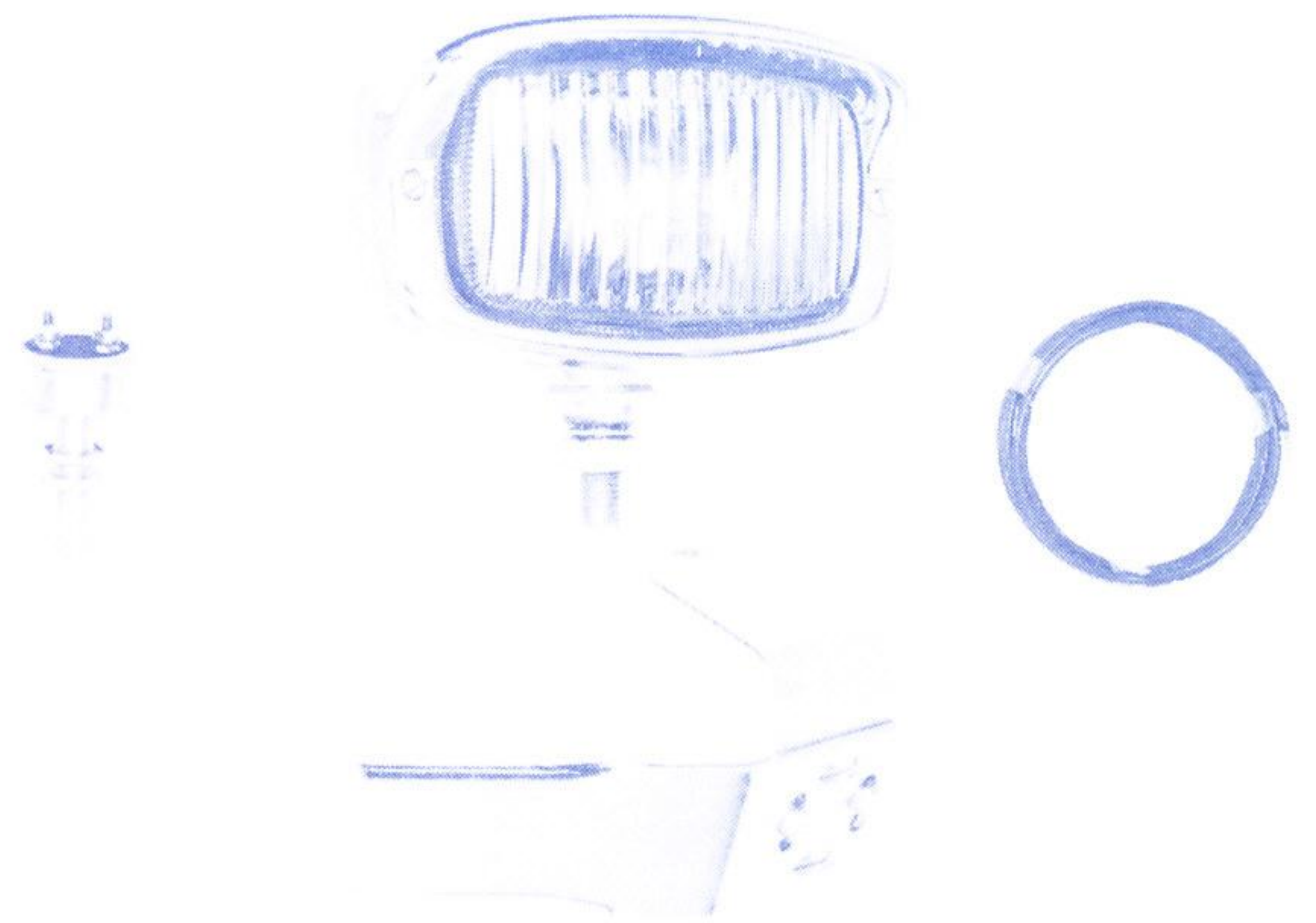

GENERAL ELECTRIC 6-VOLT SEAL BEAMS

Perfect replacement for all Volkswagens.

No. 6006 \$ 1.09 each



HIGH-BEAM SWITCH

European-style signal control

The under side of your signal lever is already designed to accept this special switch that activates your headlights even when the headlight switch is not turned on. Europeans are not allowed to use their horns promiscuously and must signal with their lights. This finger tip switch is ideal for such purposes, and will also change low beam to high beam and back again. No alteration to present system. Easily installed on all VW's, 1960 to date. Complete with switch, relay and simple installation instructions.

No. 9600

\$ 5.50 complete

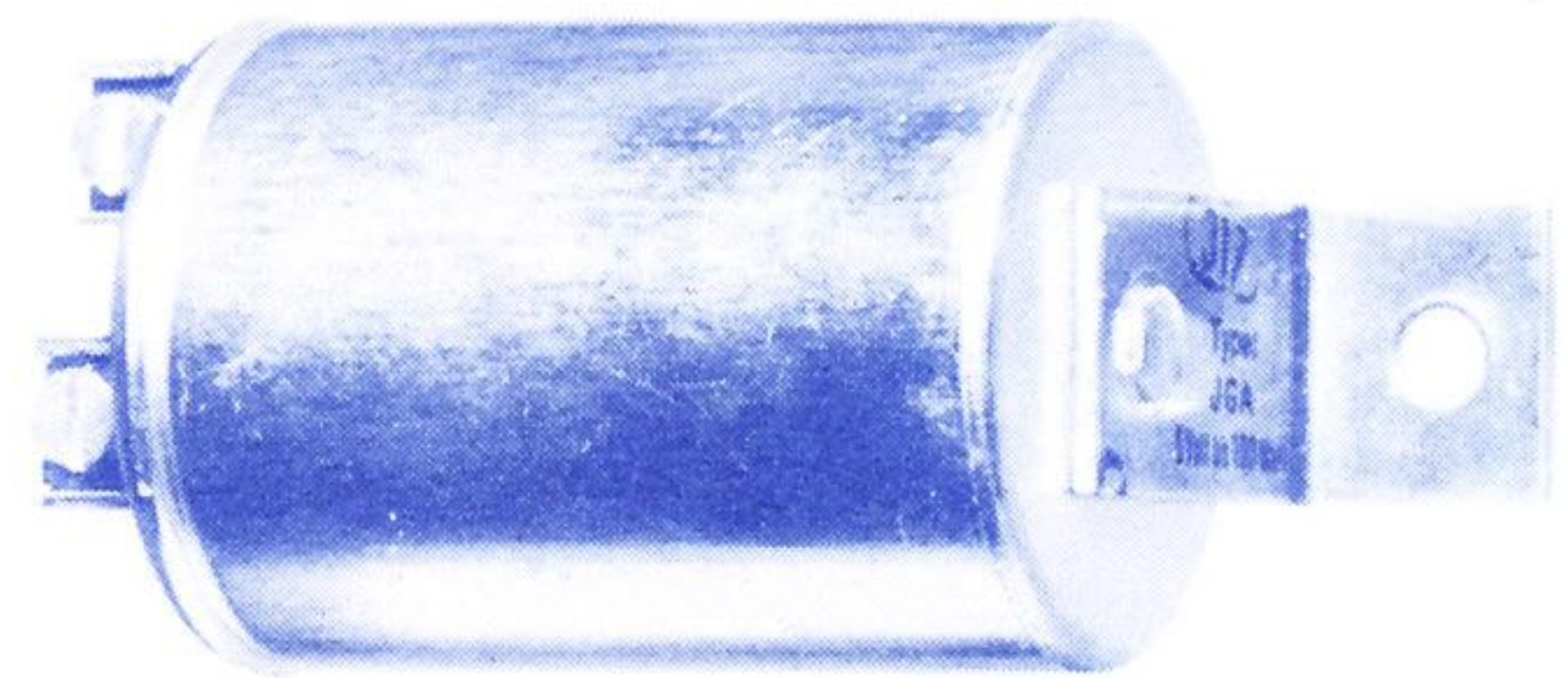
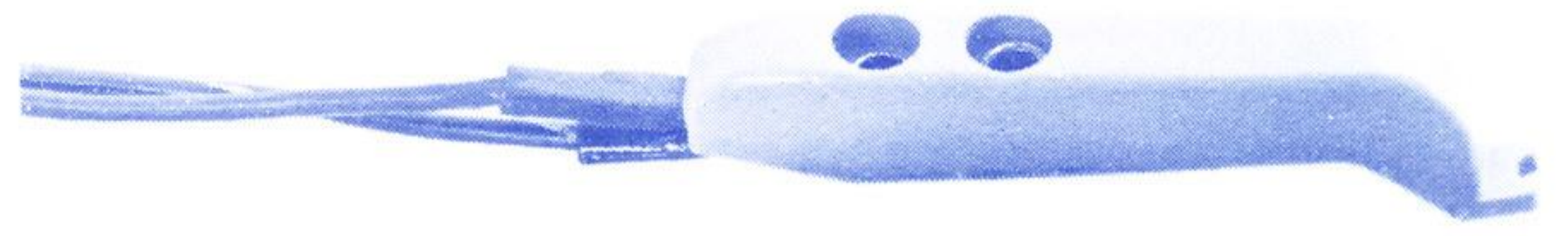

SIGNAL LEVER COVER

A practical bit of customizing. Heavy gauge chrome plated cover adds support needed to prevent breaking of the turn signal lever. Added length acts as an extension too. Locks in place with tabs.

No. 643

\$ 3.95 each

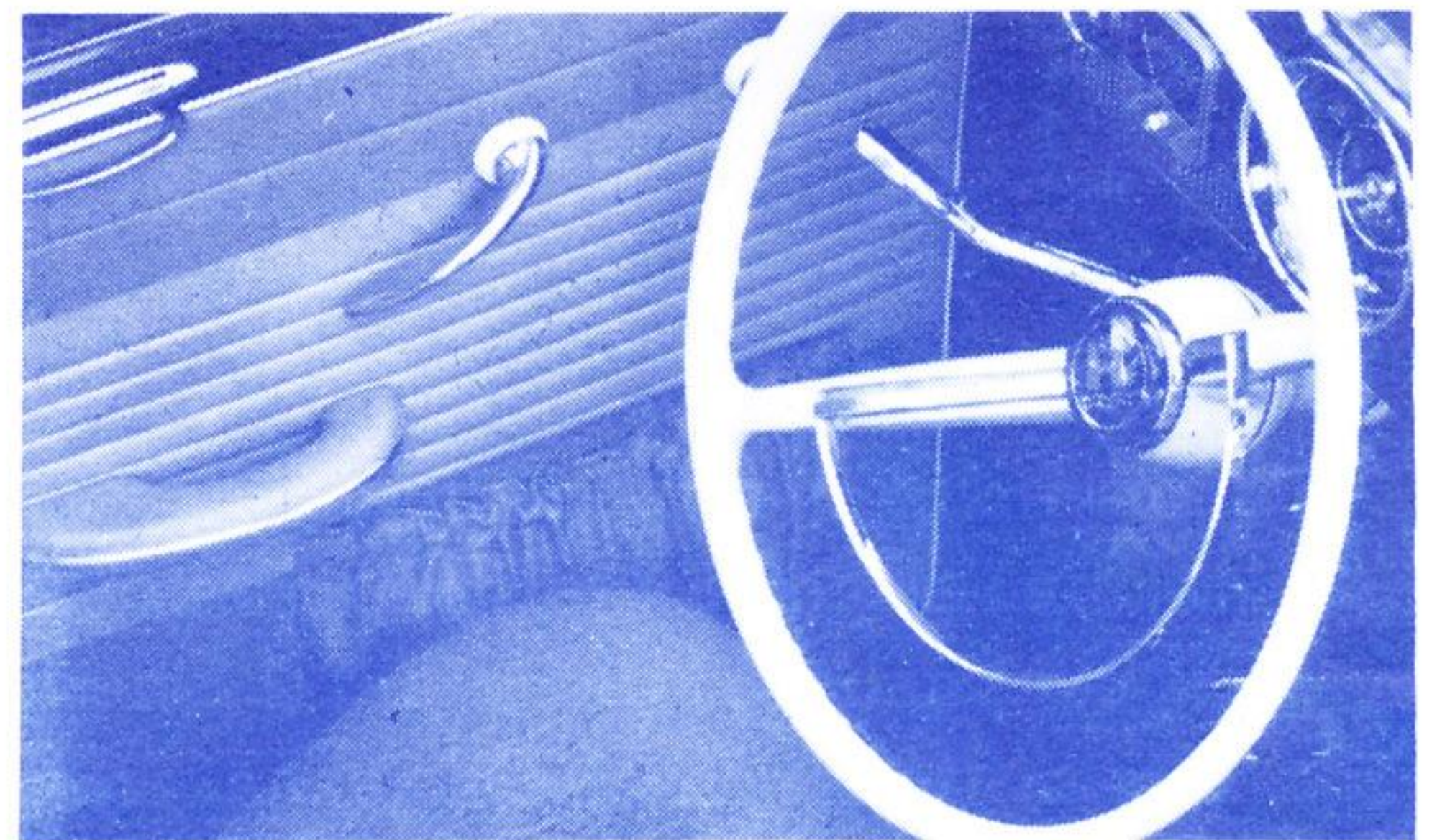

MAP LIGHT/LIGHTER COMBINATION

Unique combination; switch turns on shielded map light or operates the pop-out lighter. Complete kit supplied for quick installation in any dash. Receptacle will accommodate hand spotlight shown on Page 26. Chrome plated. For any 6 volt car.

No. 601

\$ 3.75 complete

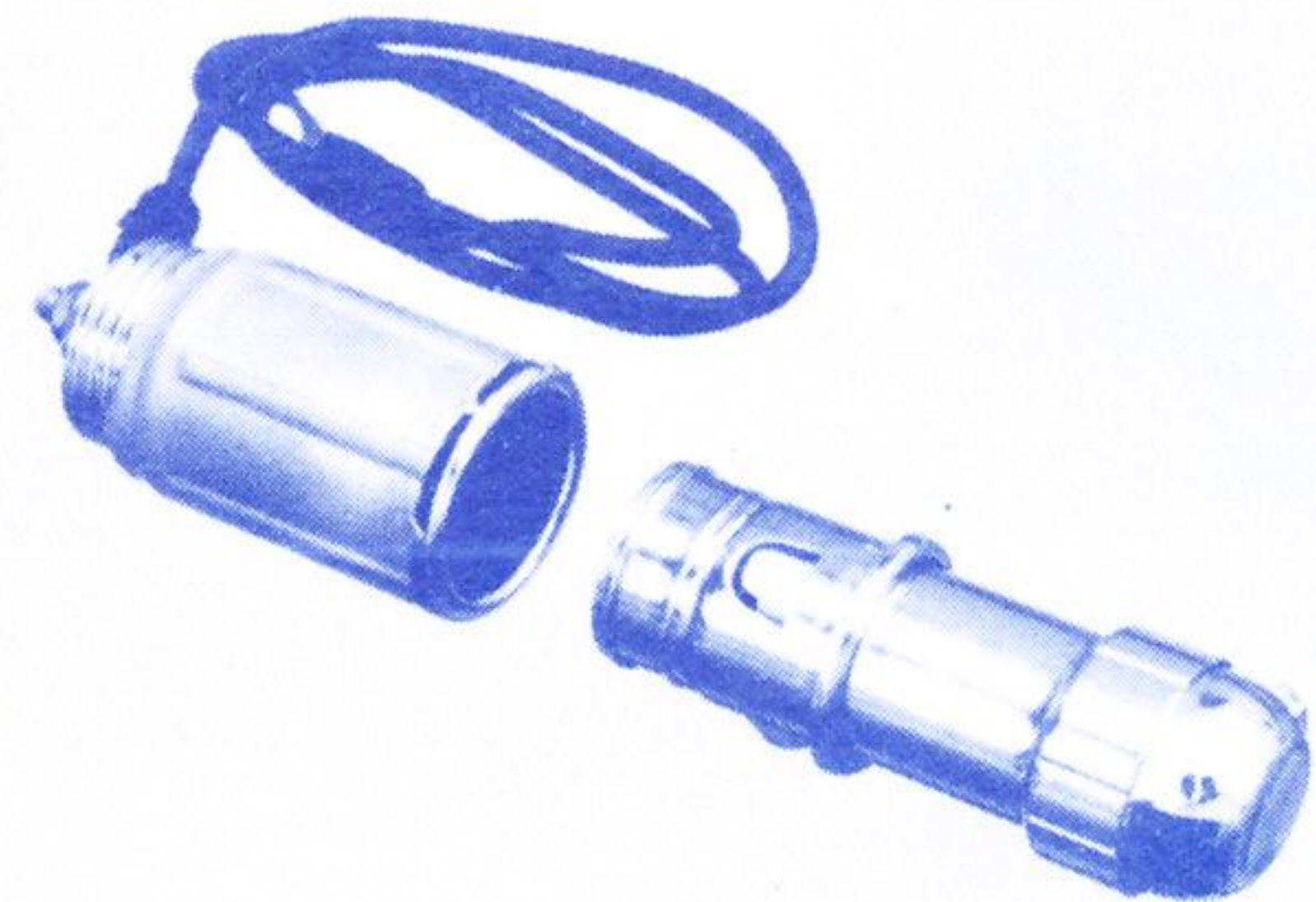

ILLUMINATED COMPASS

Head in the right direction with this accurate, finely calibrated compass. Mounts above your rear view mirror. Illuminated for night use by a standard penlight battery (no wiring needed). Added feature: the lighting unit snaps out to be used as a separate emergency light. Compass is simple to install and calibrate; instructions furnished. Colors available: Green, Tan, Black, Gray, Blue.

No. 810

\$ 6.95 each

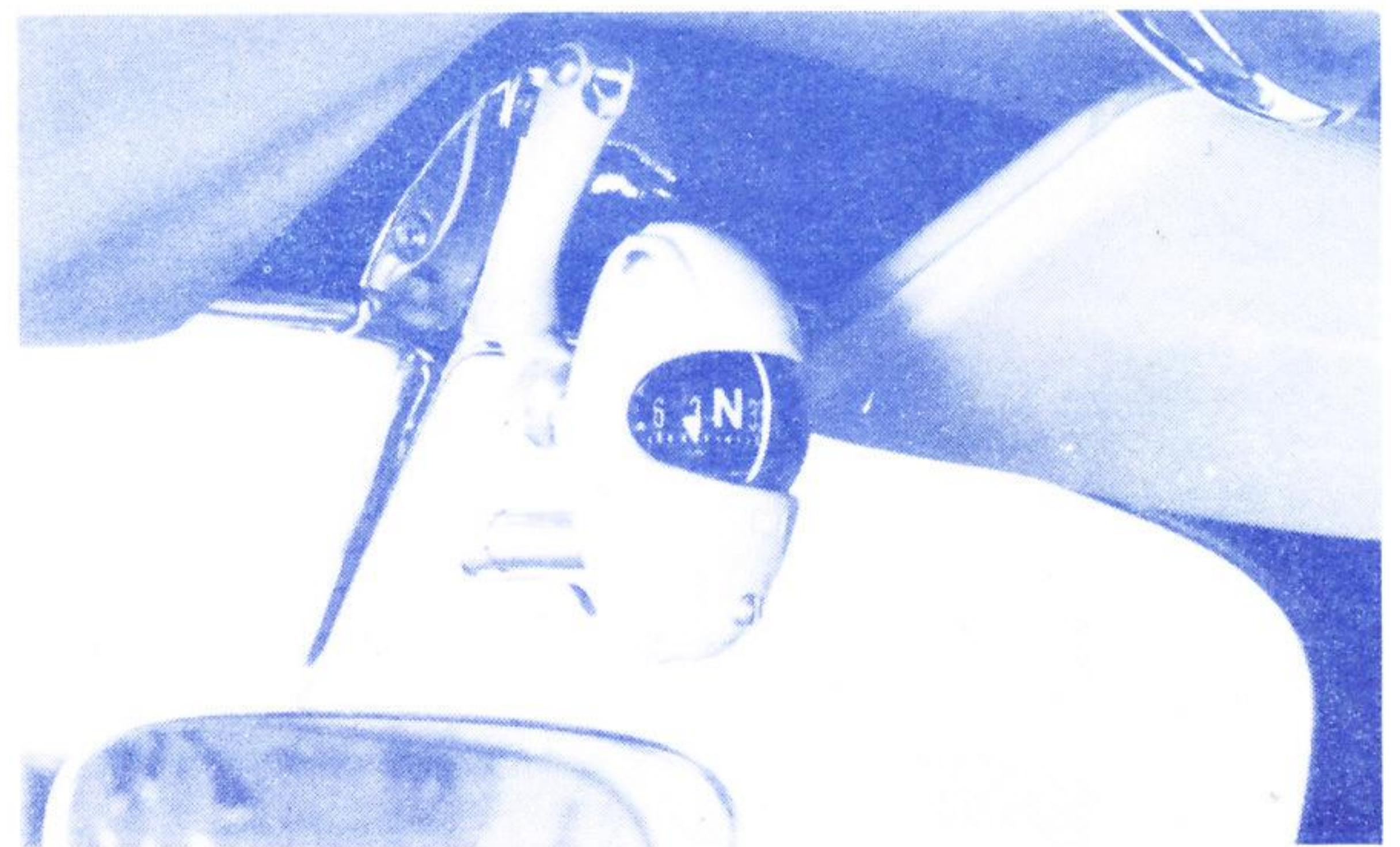

AERO-TACH

An accurate and attractive tachometer decal. Superimpose this transparency over your speedometer; it will read-out rpm's in third and fourth gears, plus standard speedometer readings. Dresses up the instrument panel as well as a \$50.00 tach. For all VW's, Falcons, Corvairs, Comets and Dauphines. Specify make, year.

No. 36

\$ 1.00 each

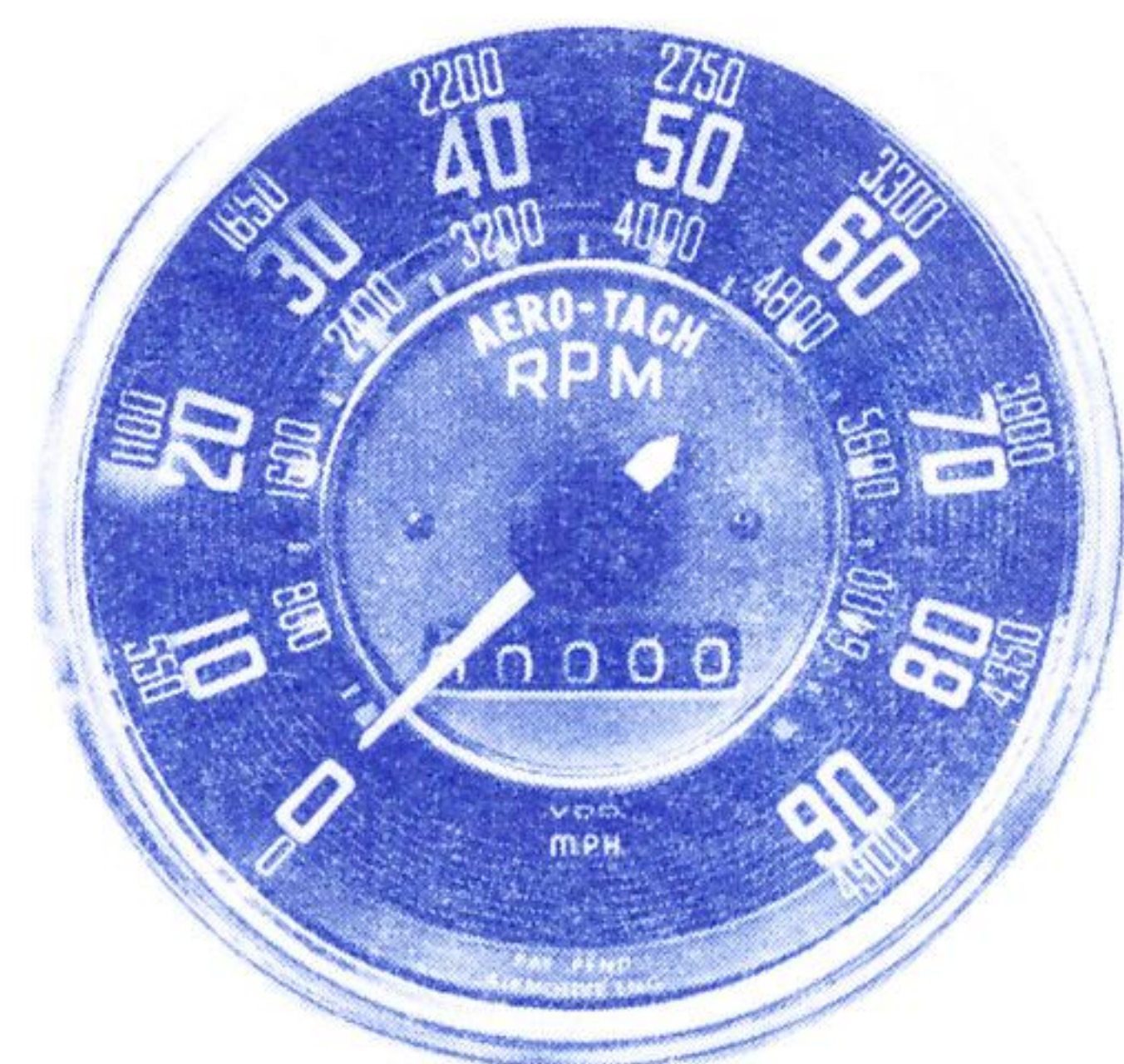

811 PROSPECT AVENUE

POLY PAD IMPORTS

CLEVELAND, OHIO 44115

Accessories for the Volkswagen Owner

FUSES

A spare package of fuses is a must for all VW owners. Each package contains 3 red 16 amp fuses and 7 white 8 amp fuses.

No. 108 **\$.40** per package

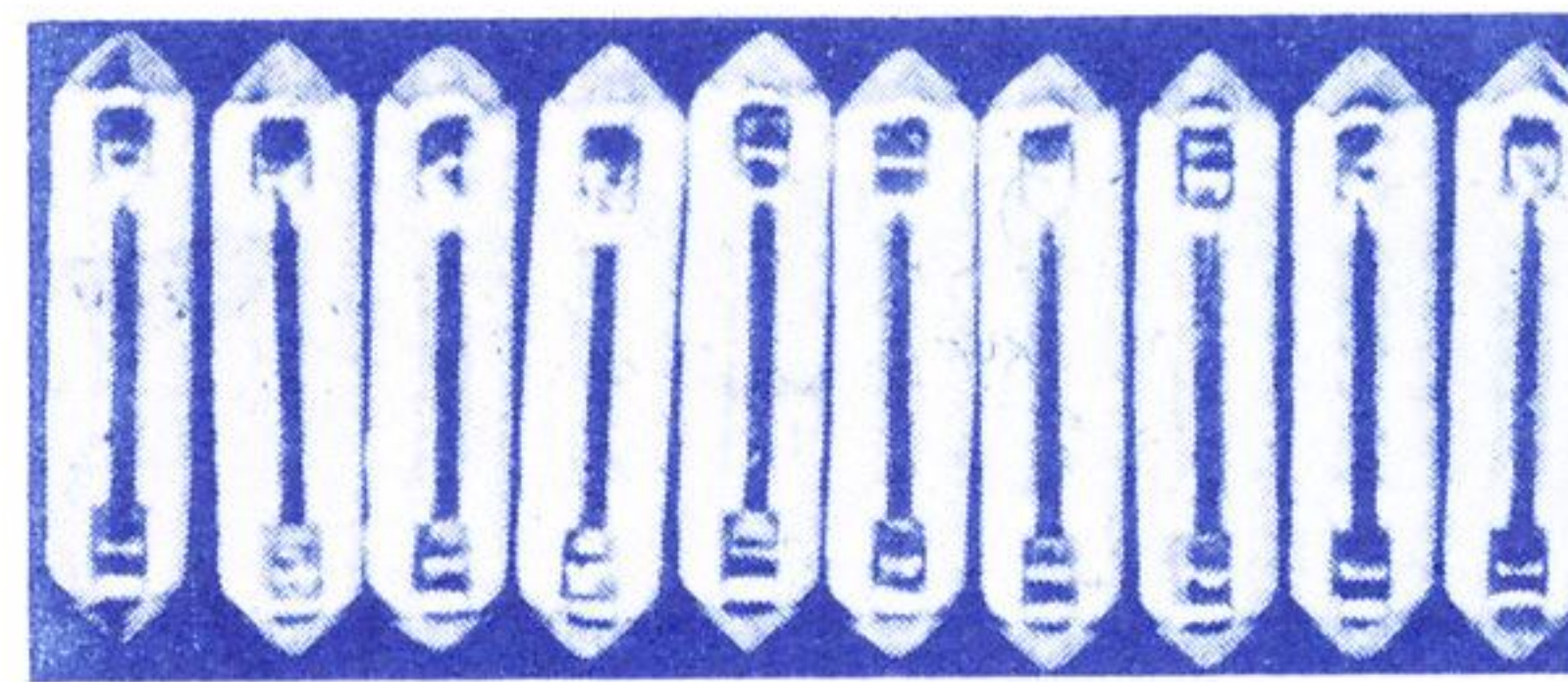

STOP-LIGHT SWITCH

Don't be caught without brake lights in working order. German-made, perfect replacement for a faulty switch.

No. 600 All models through 1960 **\$ 1.05** each
 No. 610 All models 1961 to date **\$ 1.15** each

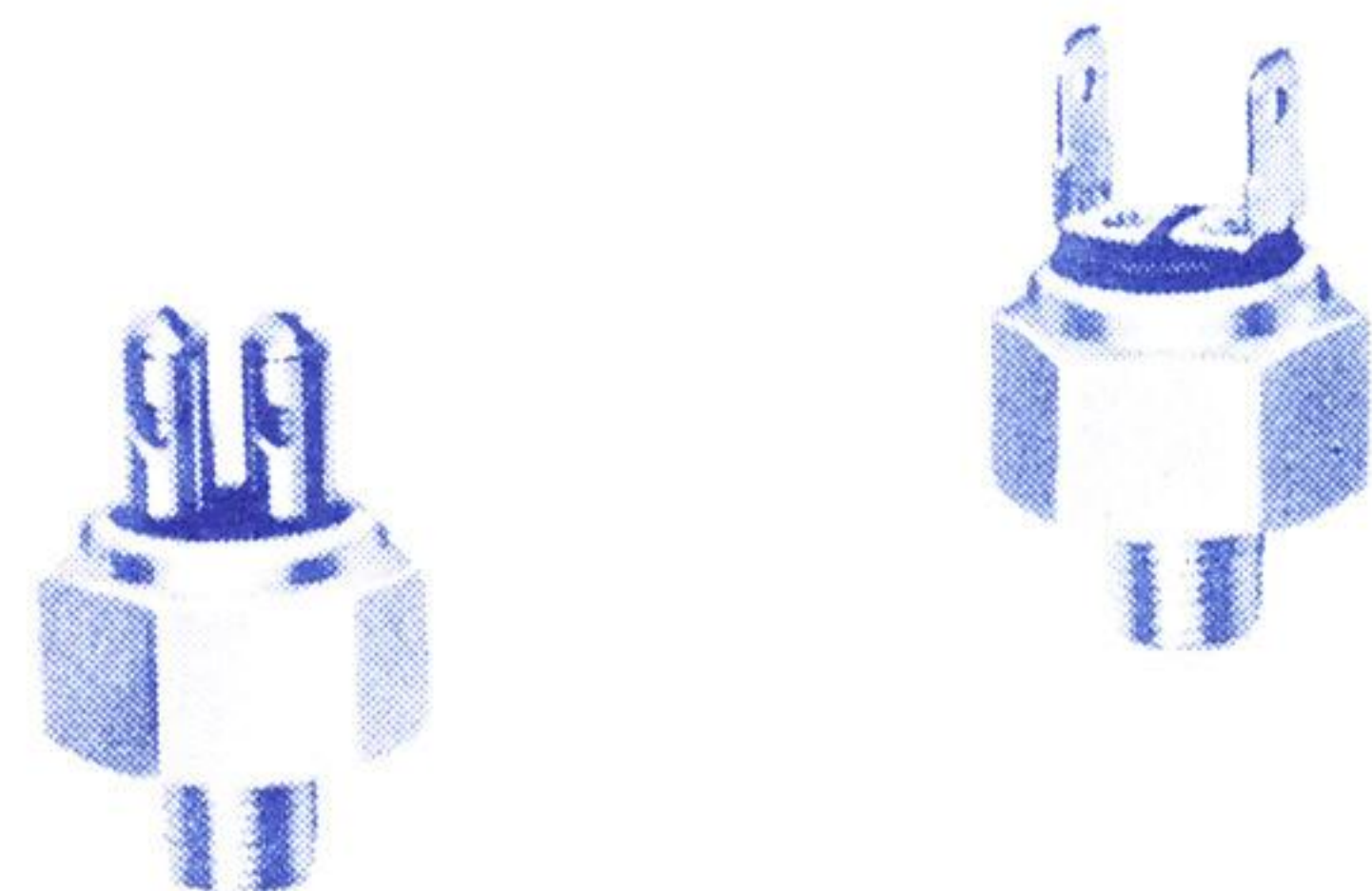

OIL-PRESSURE SWITCH

German-made, top quality replacement for all model Volkswagens. Specify year and model when ordering.

No. 615 **\$ 1.25** each

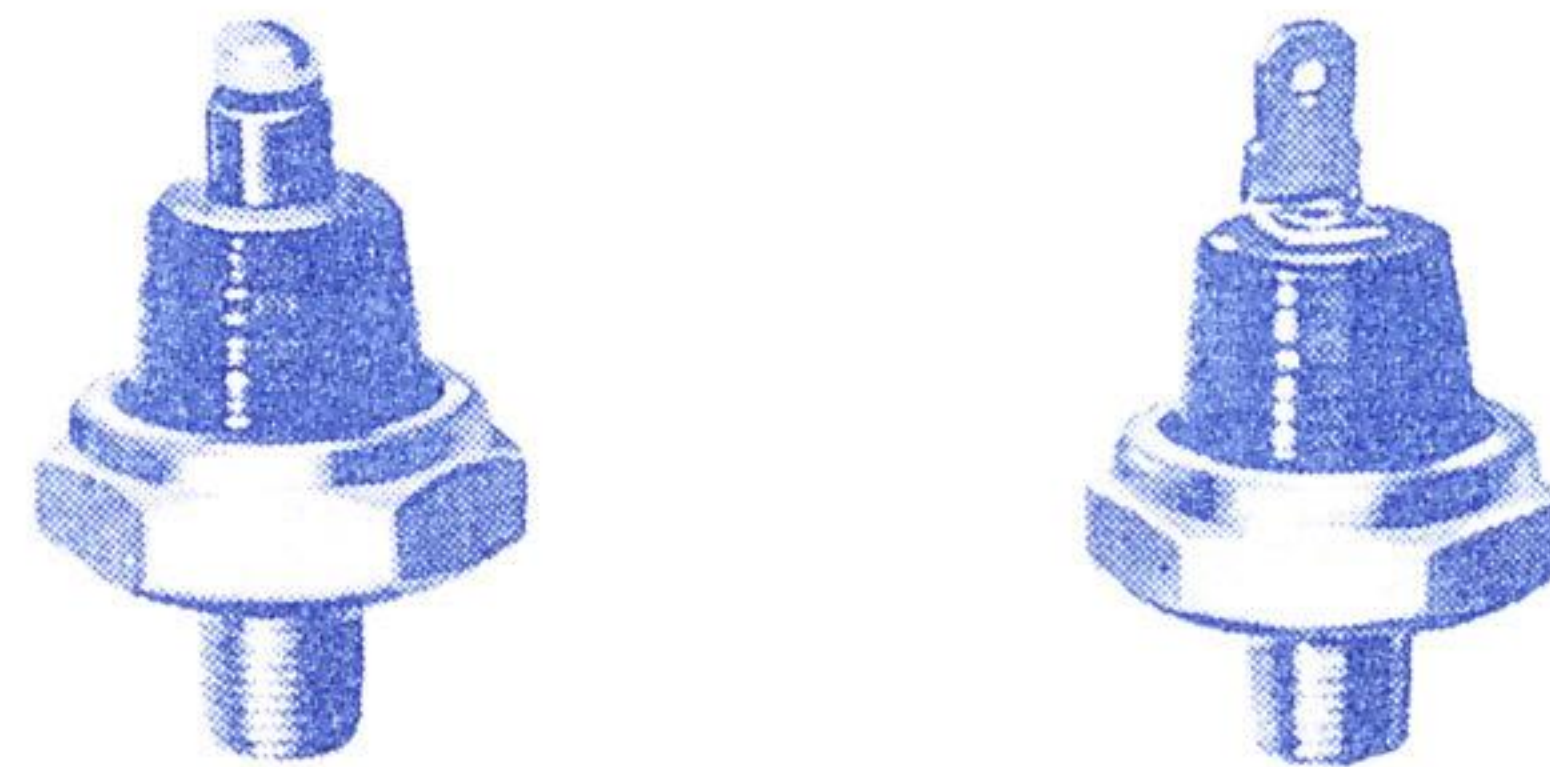

HEAT-SEALS

Seal the air-cooling system around the spark plugs. Replace worn seals to improve engine cooling in summer and for better maintenance of heat in winter. New seals will improve heater and defroster warmth, assure proper cooling for high speed steady driving. For all VW's, Ghias and Transporters.

No. 35 **\$ 2.00** per set of 4

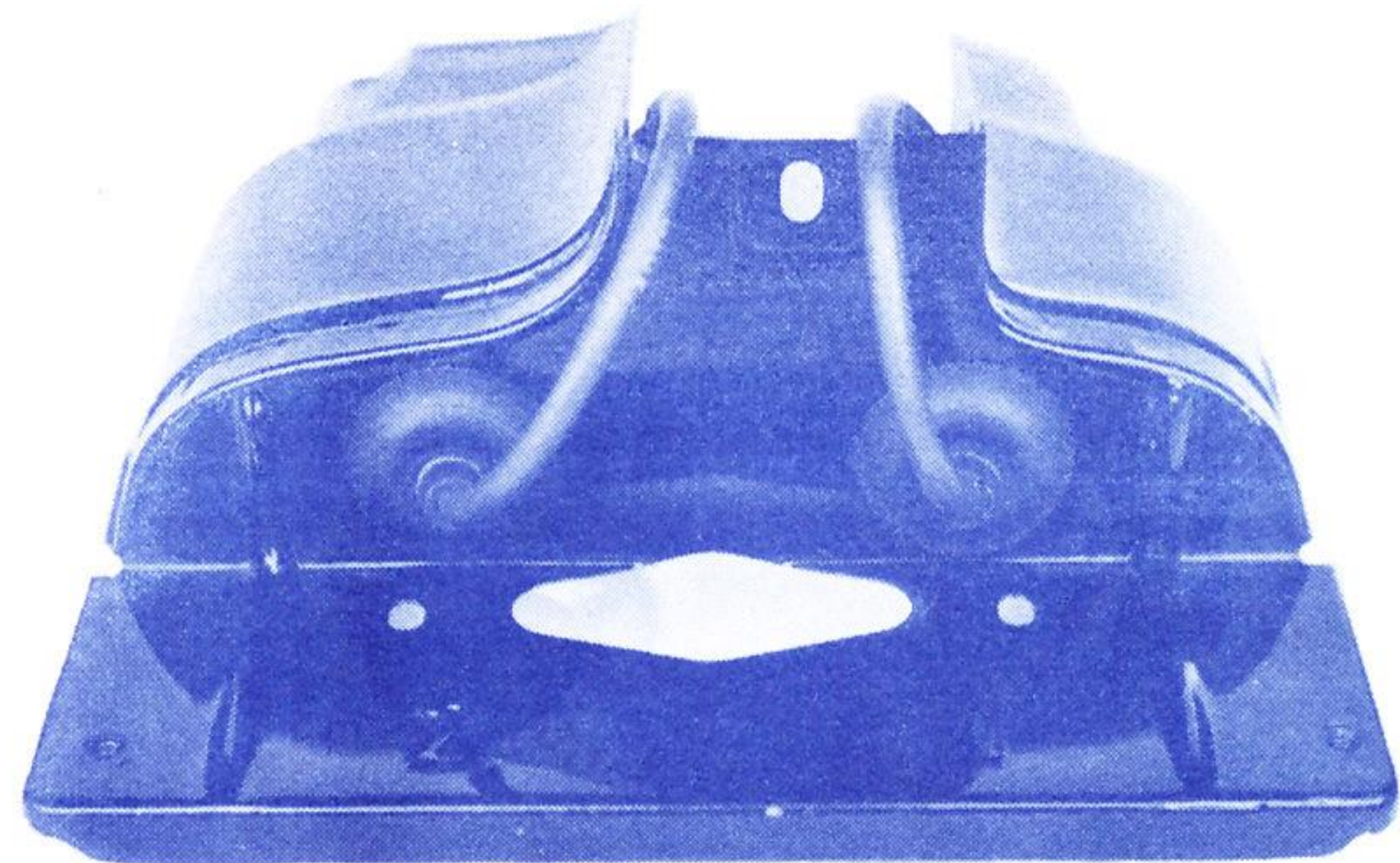

DRYCAPS

Insure positive, fast starts in any weather. Drycaps fit over the ignition wire and spark plug connector and seal out dirt, moisture, gasoline, oil and dust particles that can cause shorting and reduction of ignition voltage. Will not blister, crack or burn. Oil resistant. For all years and models.

No. 707 **\$.75** per set of 4

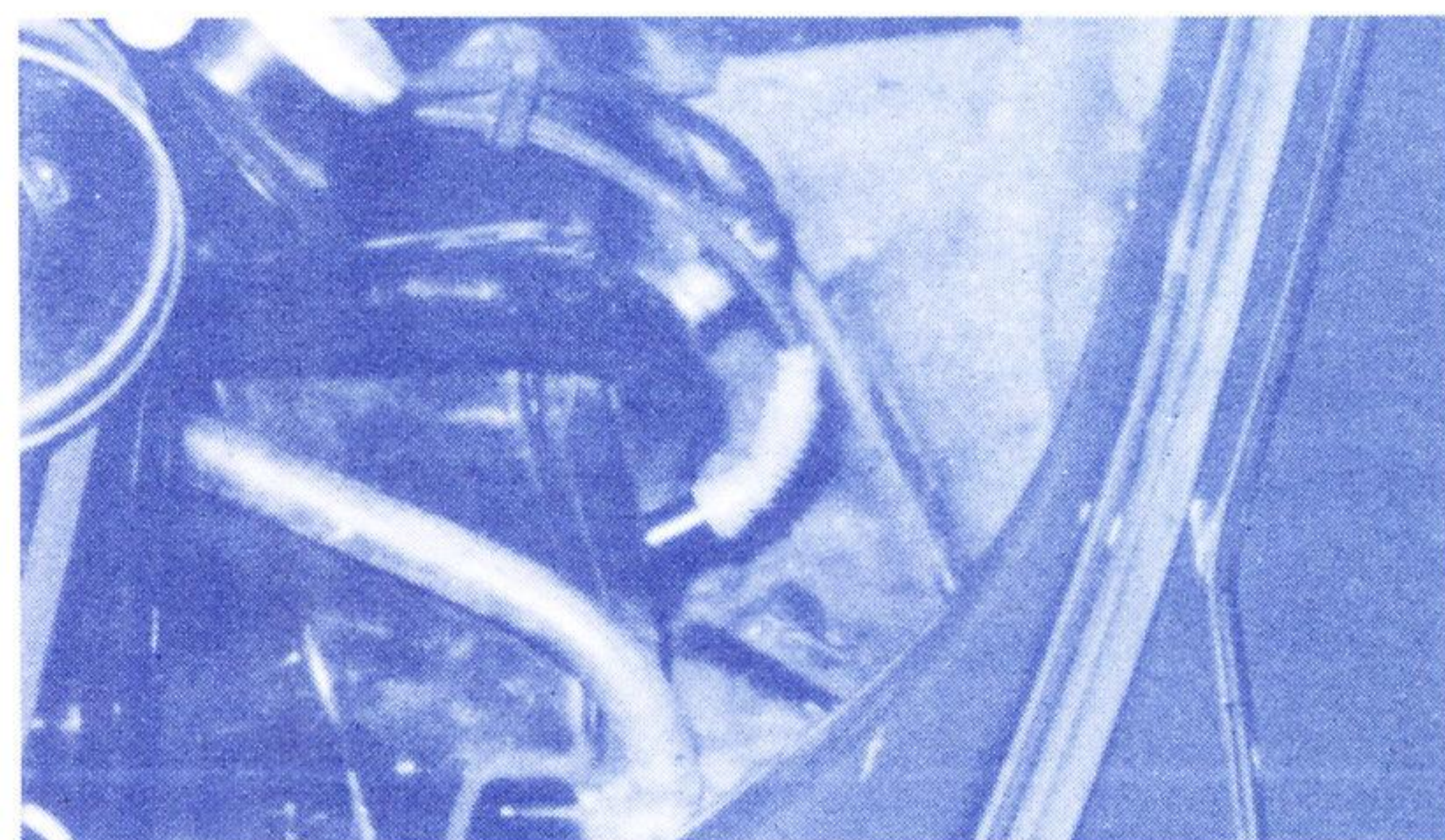

SPARK-PLUG CABLE SET

for Faster Starts and Smoother Performance



Replacement cable set complete with seals. Cable is Delco Packard TVRS, neoprene jacketed, for maximum resistance to oil, abrasion and moisture. Graphite impregnated conductor controls ignition voltage to suppress static and impulse interference to radios and TV sets. Complete set includes all new neoprene heat seals. Terminals are brass inserts with spring clips for positive contact. An excellent investment. For all Volkswagens.

No. 1325 **\$ 5.95** per set

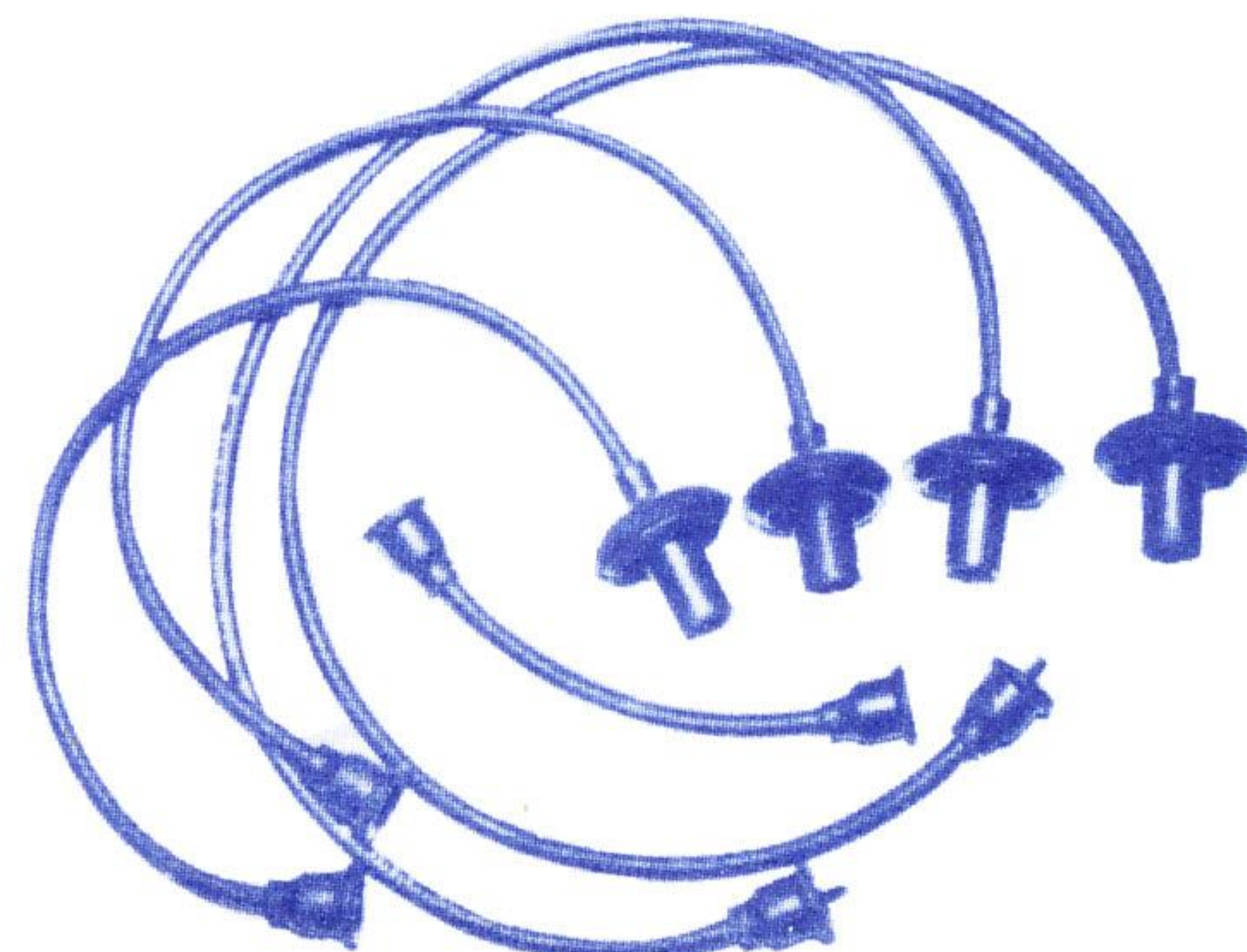

ECONOMICAL RADIOS FOR THE VOLKSWAGEN

A collection of American-made, fully transistorized radios customized for your Volkswagen. Each radio shipped complete with mounting hardware, custom trimplate, heavy-duty speaker and antenna. Each carries a 2-year guarantee! Each can be custom-mounted in your car easily, ready to play after a minimum of installation time.

AM Car Radio with Pushbuttons:

- Tone Control
- Automatic Gain Control Circuit
- 6 transistors, 2 diodes
- No warm-up time
- Rugged construction

FOR ALL VW 1200 SEDANS

No. UA-702 **\$39.95** complete

AM Car Radio, Manual Tuning

Same as above less pushbuttons and tone control. Looks like a pushbutton radio.

FOR ALL VW 1200 SEDANS

No. UM-701 **\$36.95** complete



AM/FM Car Radio, Manual Tuning

- High Sensitivity
- 10 watts Peak Audio Power
- Instant play (no warm-up time)
- AGC and AFC
- 11 transistors, 6 diodes, 1 thermistor
- Tone Control
- Die Cast Case

FOR ALL VW 1200 SEDANS

No. VWM-751 **\$79.95** complete

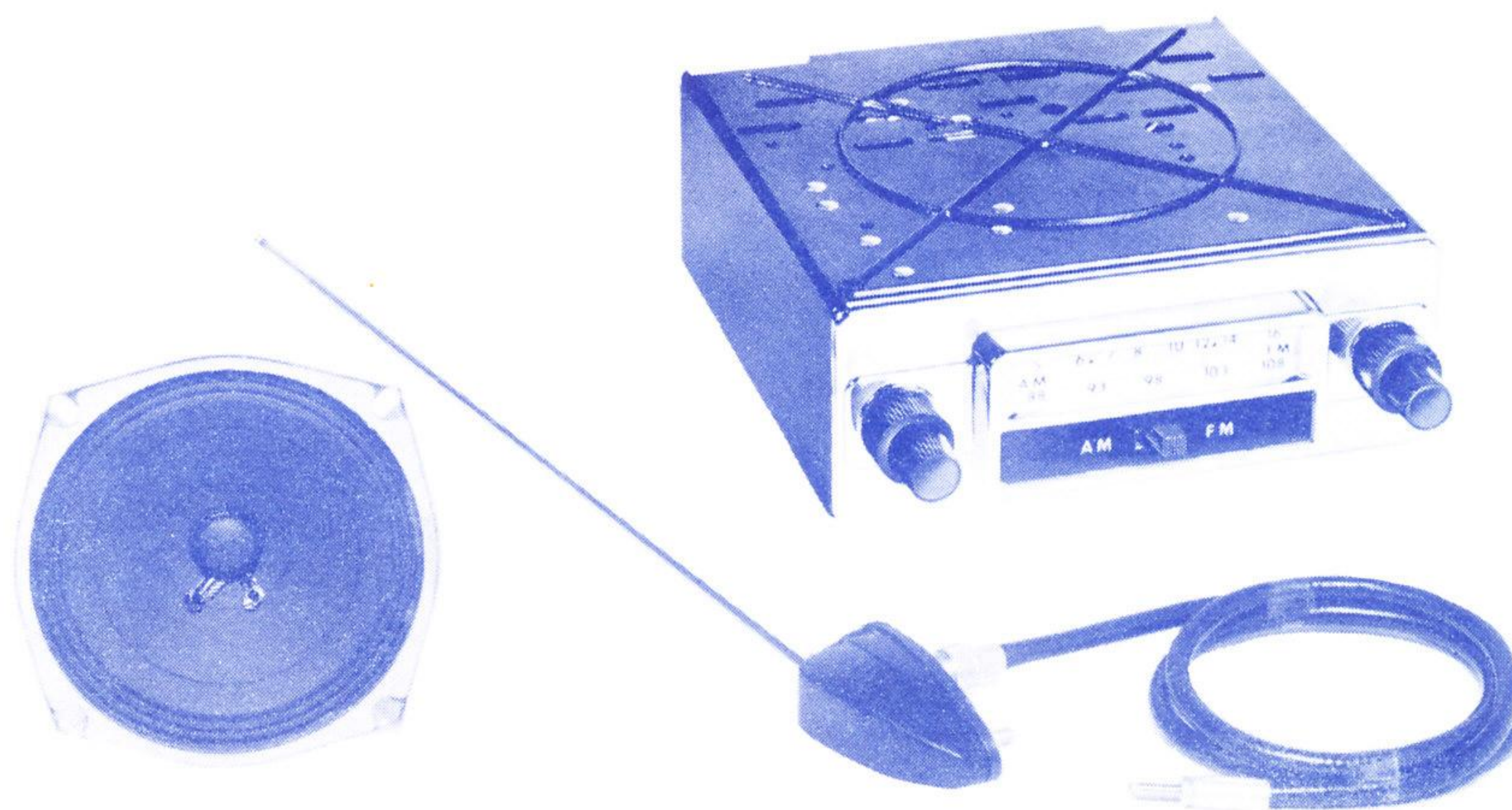

SIDE-MOUNT ANTENNA

Popular tear-drop style antenna for Volkswagens. Triple chrome-plated. Molded tenite insulator base. Extended length, 56½"; collapsed length, 20½". Detachable lead is 36" long.

No. 709 Tear-drop side mount

\$ 3.75 each

No. 709T Universal top cowl mount antenna

3.75 each



WORLD-RENOWNED DUAL-PURPOSE TRANSISTORIZED RADIOS!
High Fidelity in your Car . . . or at Home, the Beach, Anywhere!



The **NEW** DERBY

. . . A Standard in the Industry!

A great portable and a superb car radio! Offering FM, AM, Shortwave and Marine Bands automatically selected by push-button, the Derby has excellent fidelity and bass response and unusual audio power for a radio of this type. *Featured in the New Model:* Separate treble and bass tone controls, Automatic Frequency Control (AFC), increased sensitivity and audio output, visual on-and-off indicator. Portable uses 6 inexpensive "D" flashlight batteries (300 hour playing time), has its own telescoping antenna and removable handle. Instant play — no warm-up time! Under-dash bracket has lock to prevent theft of radio, provides automatic connection to car's battery and outside antenna when radio is inserted. The Derby has inputs for your tape recorder or record player and a jack for an external speaker or earphone. Weight 6½ lbs.; size 10.6" x 7.8" x 3.4".

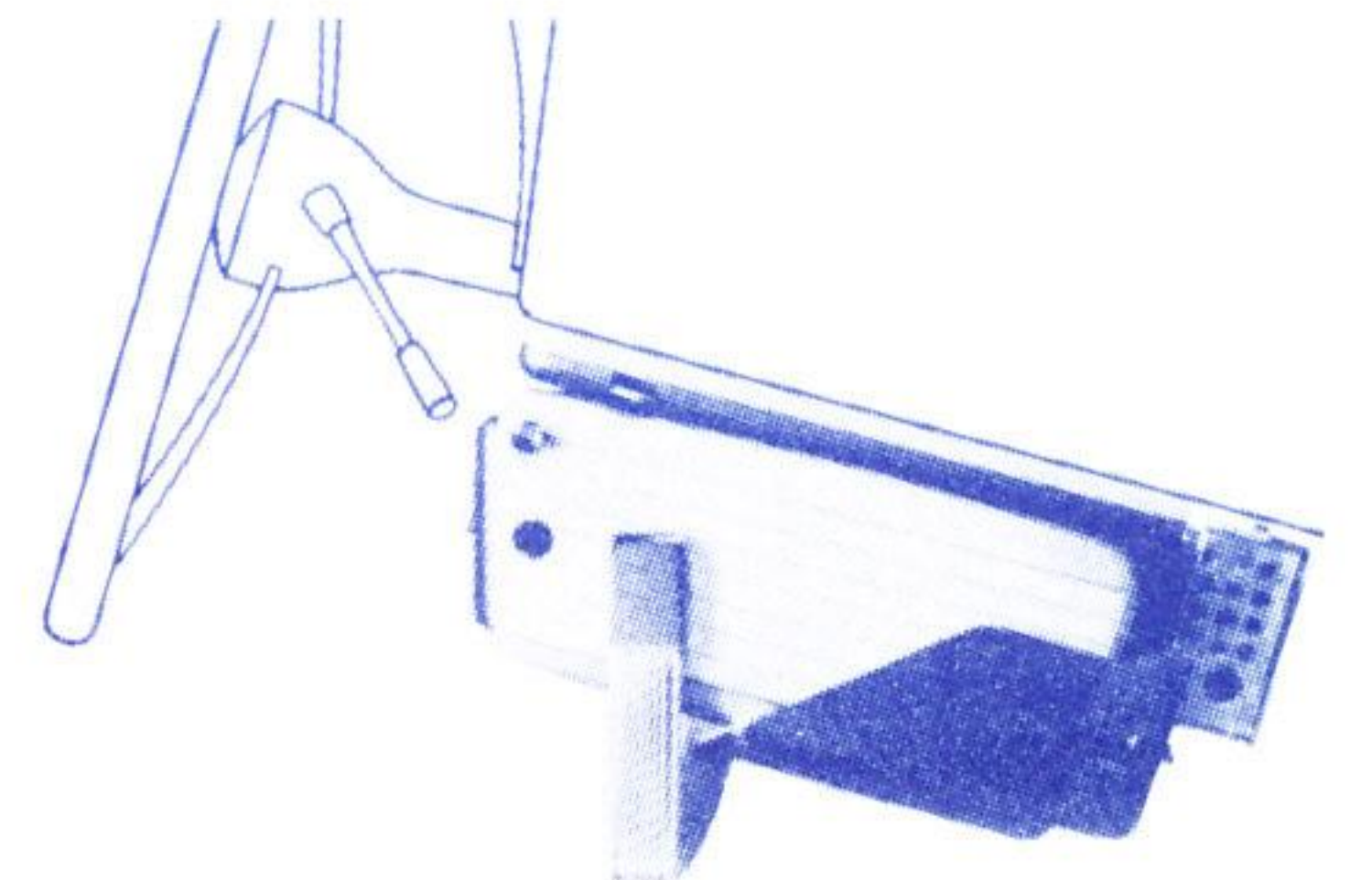
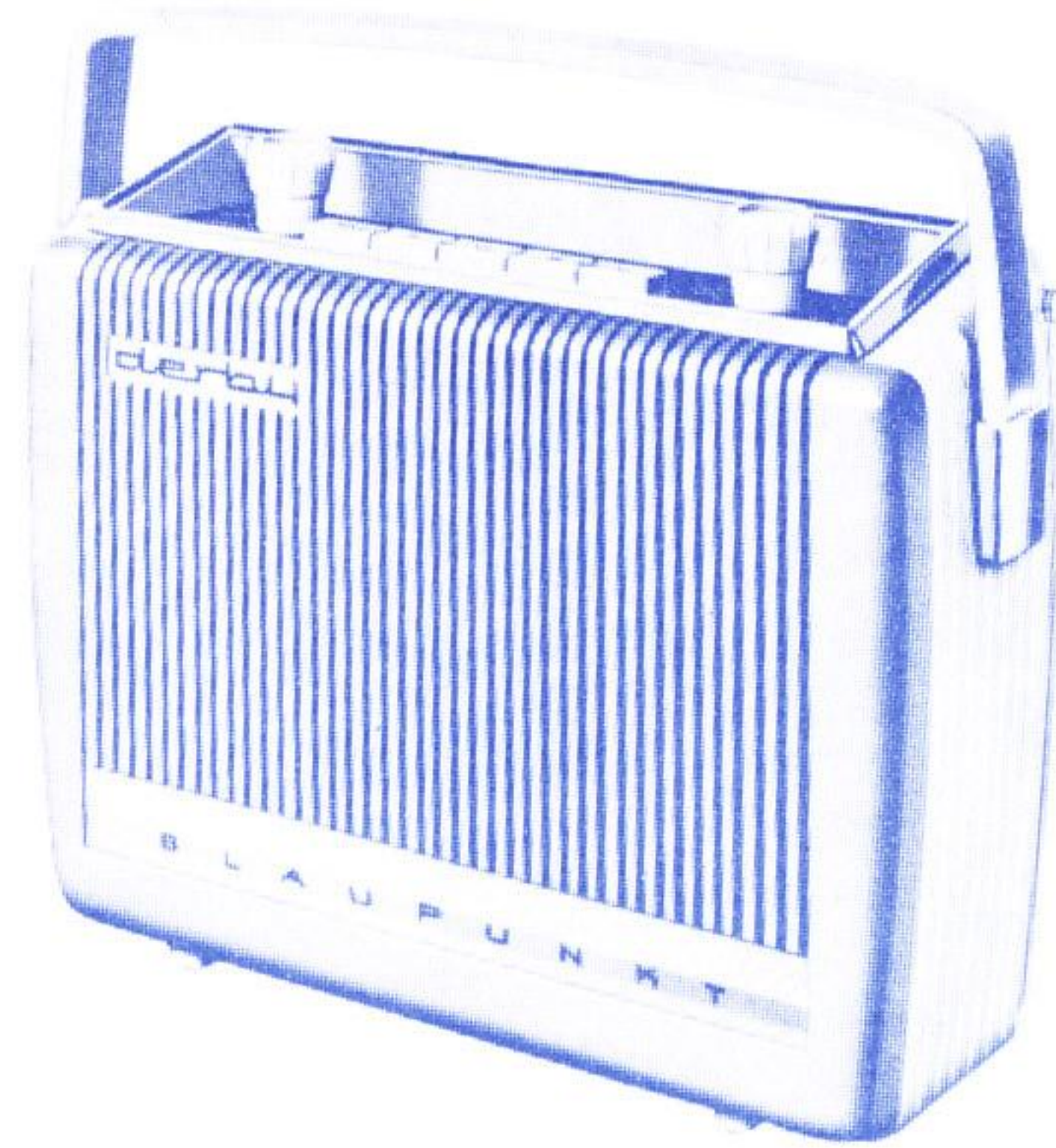

- No. 94770 The DERBY radio — for any 6 or 12 volt car** **\$89.95**
- No. HV450 Under-dash auto installation bracket** **19.00**

Available in Black or Light Blue
11 Transistors and 6 Diodes

The AMERICAN

. . . A Portable that Custom-Mounts in the Dash!

FM, AM and Marine Band

A compact portable (6-5/8" x 5¼" x 1-5/8") weighing only 2 lbs., the American slides into the dash to automatically engage outside antenna, car's battery, auxiliary amplifier built into bracket and separate speaker. Radio can only be removed when ignition is on; when removed a "door" automatically covers the opening to keep appearance neat and trim. Auxiliary amplifier provides extra power to overcome even the most extraordinary amount of road noise. Special features: Pushbutton band selection, telescoping antenna, tone control, flip-up carrying handle. As a portable, the American uses 4—"AA" penlight cells. Installation kit is complete with custom-mount speaker, all hardware and trim-plate and suppression materials.

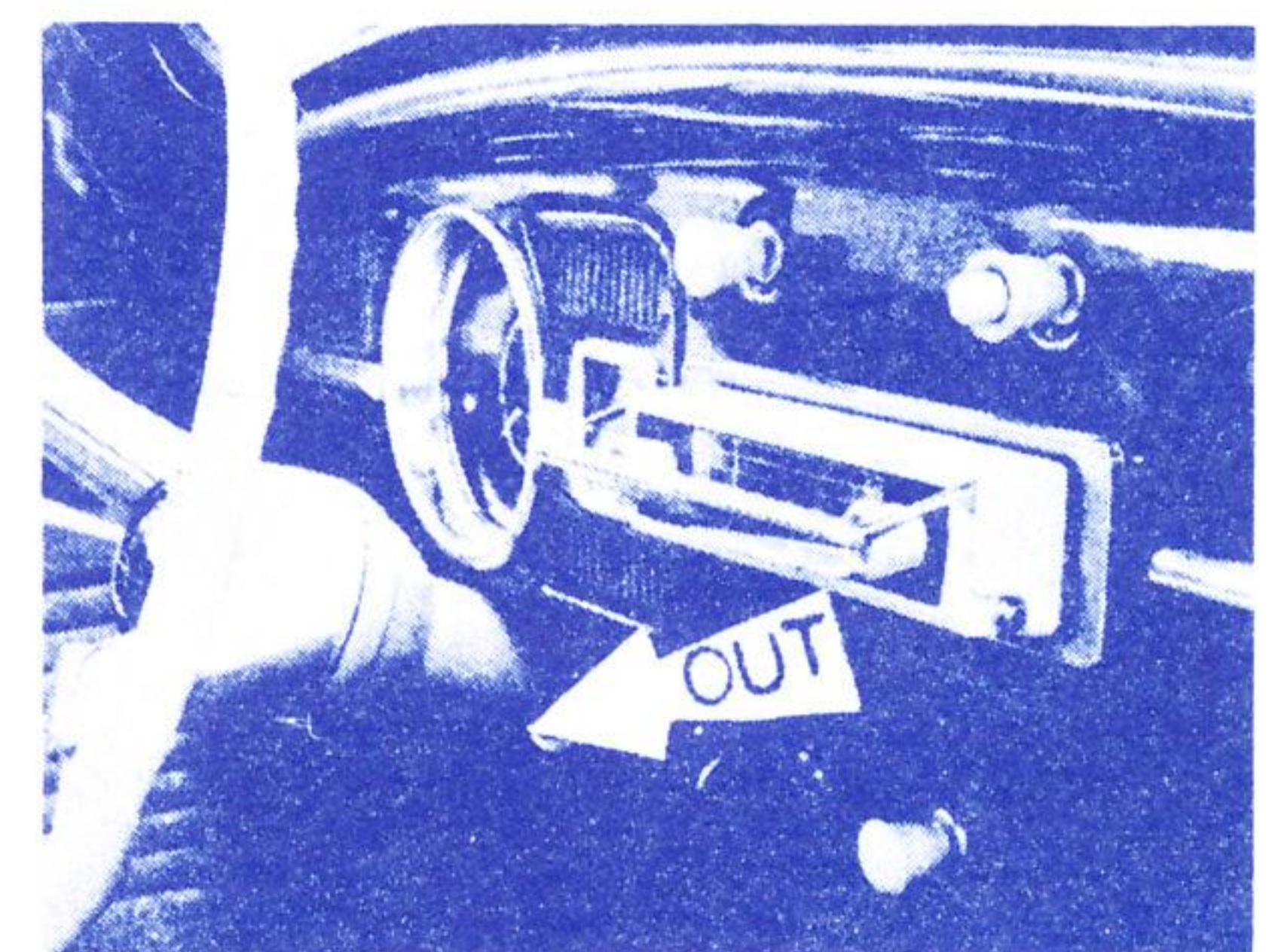
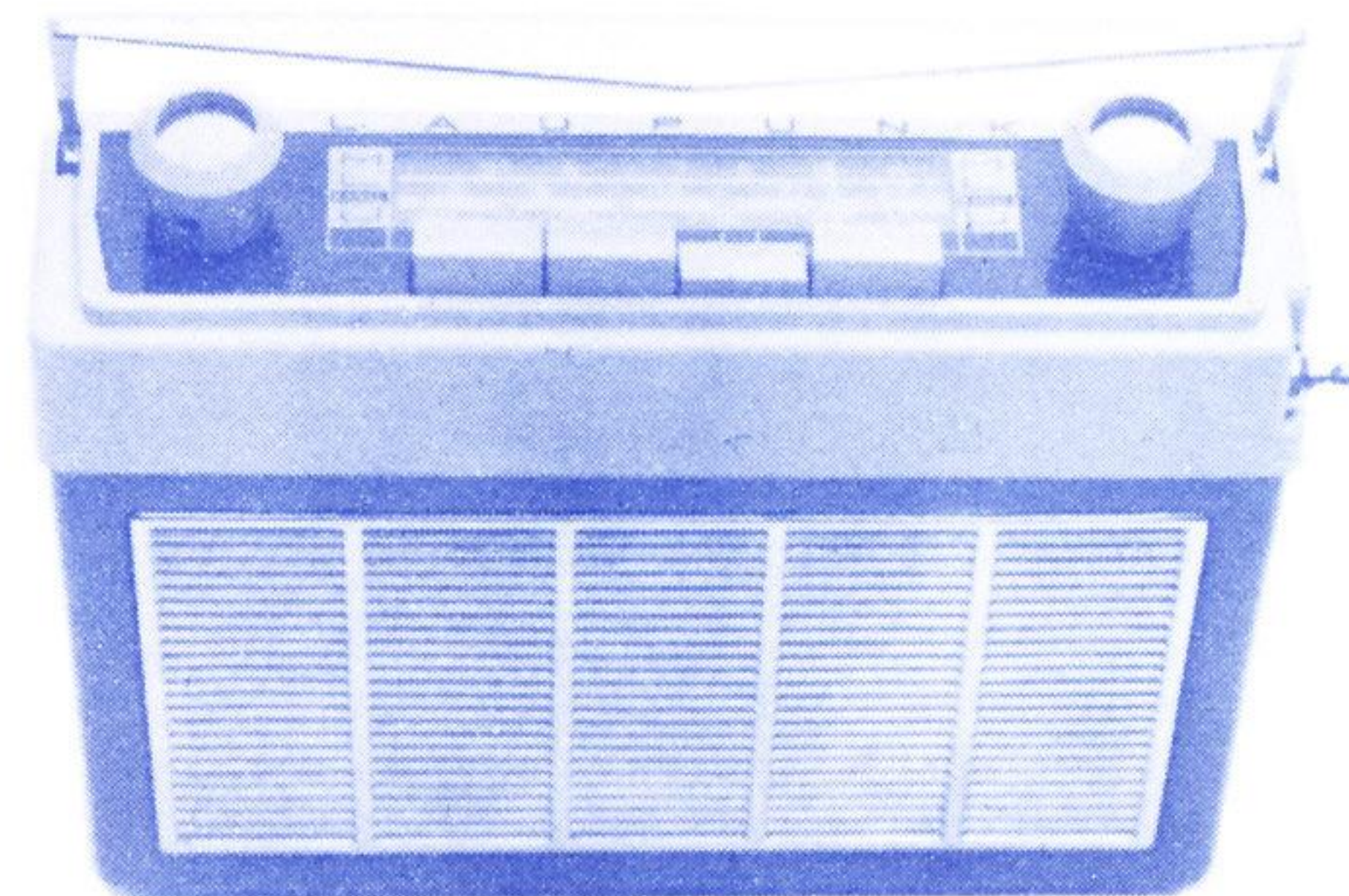

- No. 33040 The AMERICAN radio — for all 6 or 12 volt cars** **\$89.95**
- No. 81323 Installation kit for VW 1200's** **20.50**
- No. 81393 Installation kit for VW 1500's** **20.50**

Custom installation kits available for many other cars.
 Prices on request.

Color — Black
12 Transistors, 5 Diodes as a Portable
14 Transistors, 6 Diodes in the Car

Please See Next Page for Antenna Information



ANTENNAS

Will an FM Car Radio Perform up to the Manufacturer's Design Standard?

Each circuit in a radio has some impedance value. In the case of the standard American-made radio, the antenna circuit impedance is usually 52 ohms, to which American-made auto antennas will match; the German made Blaupunkt FM radios, however, use antenna circuit design around a 30 ohm impedance and the use of a standard 52-ohm domestic antenna results in a mis-match which produces a serious loss of radio signal. For this reason, the use of the Robert Bosch antennas pictured is strongly recommended. All are well-made of quality materials, hold up extremely well under the conditions in this country and perfectly match the antenna circuit design of all Blaupunkt radios, to achieve the maximum sensitivity and distortion-free performance built into each instrument.

- No. S115A Side Cowl Mount \$ 5.35 each
- No. T150G Top Cowl Mount \$ 7.15 each
- No. V106G Retractable \$ 7.85 each

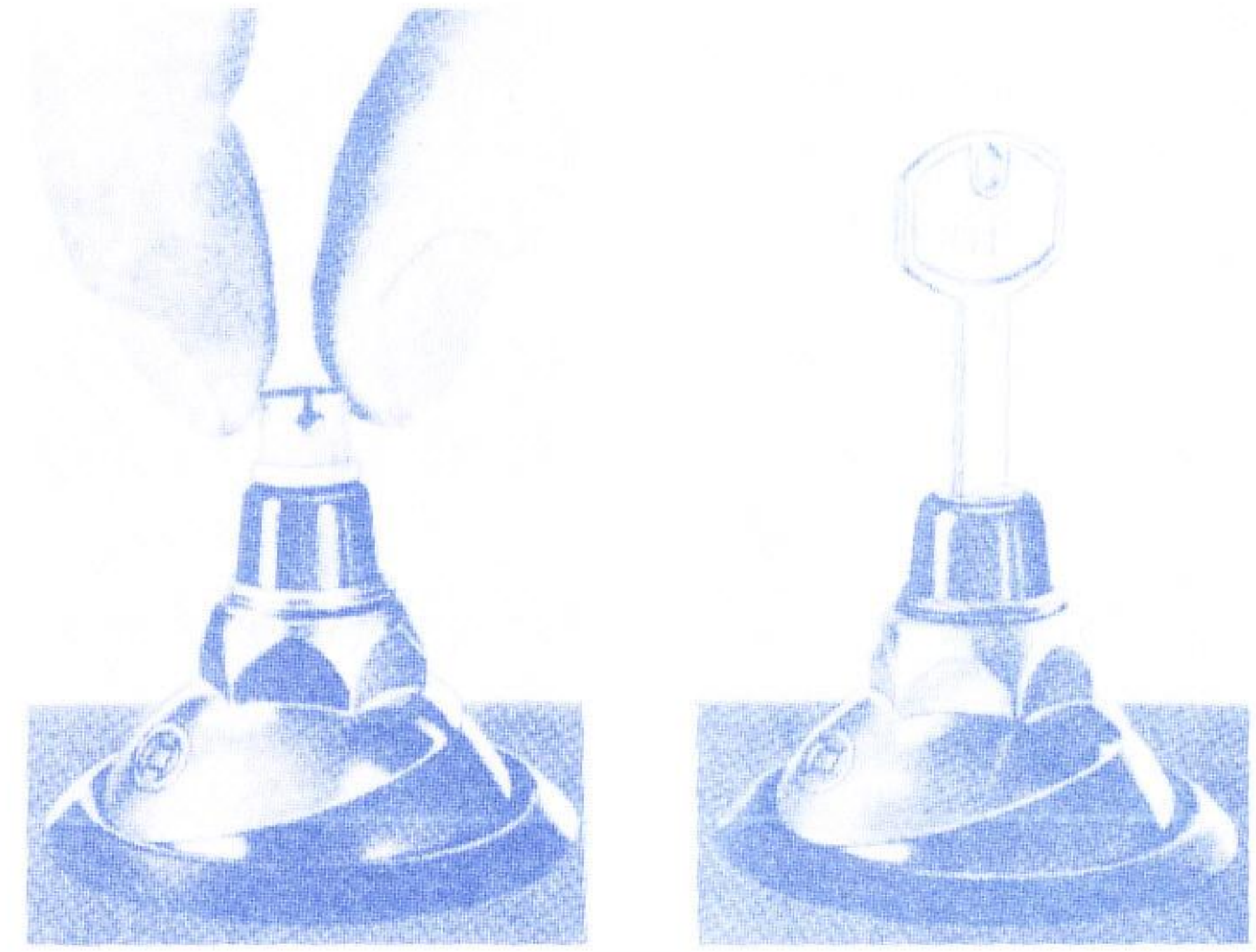

V-106 G . . . Retractable

The V106G retractable or disappearing antenna can be "locked" below surface of cowl to prevent vandalism; keys supplied with each antenna. Can also be retracted without locking feature.

HI-FIDELITY SPEAKERS

NYR 112 - Compact ceramic magnet speaker in its own sturdy, attractive enclosure. Ideal for mounting in rear well, on fire wall or side panels. Mounting hardware and wiring included. Size of enclosure 7" wide by 5 1/4" high by 3 1/2" deep.

- No. NYR 112 \$15.75 each

NYR 110 - 6" x 9" ceramic magnet speaker, ideal for mounting in rear deck or side panel. Complete with metal grill, wiring and hardware.

- No. NYR 110 \$11.95 each

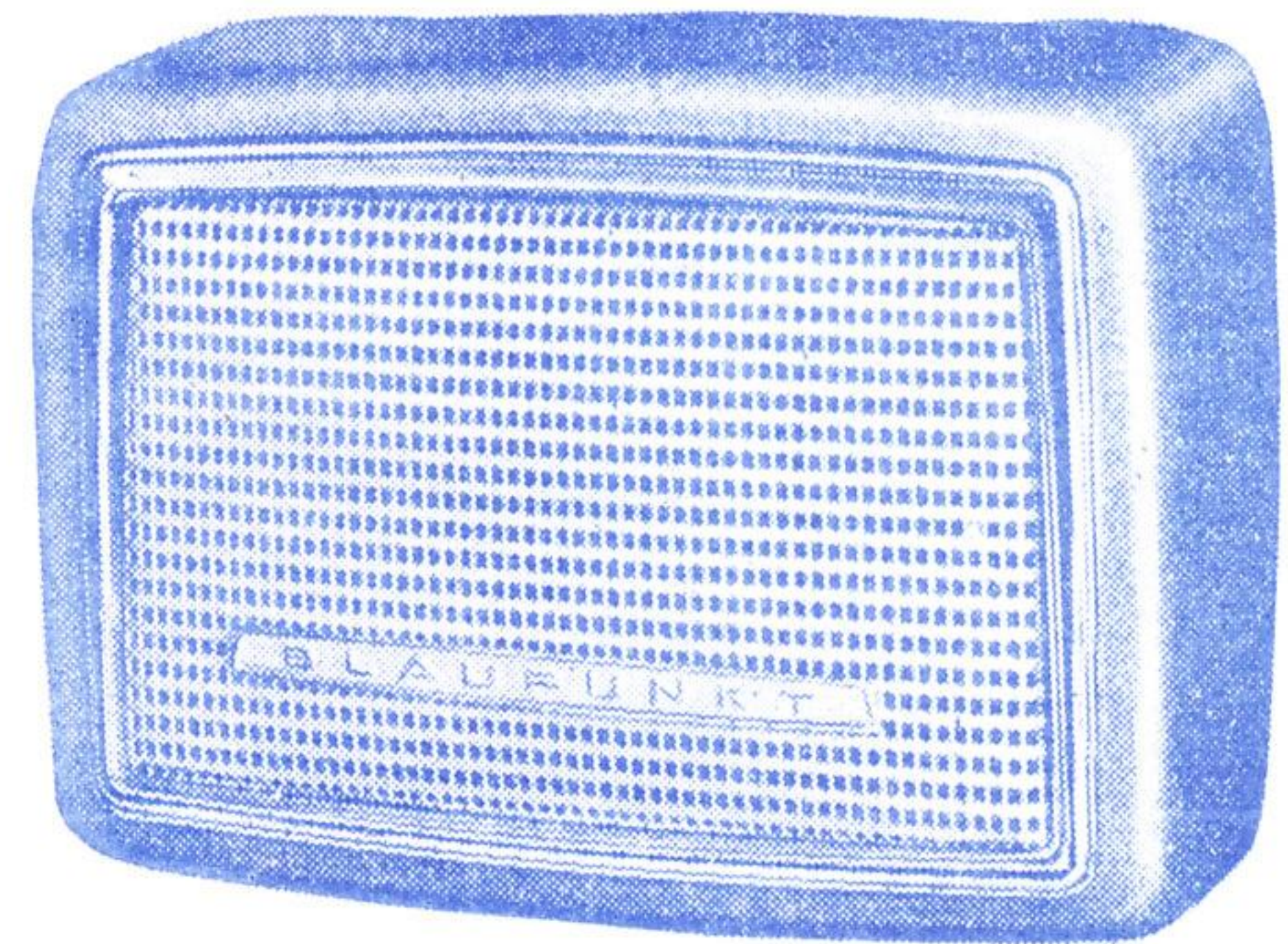

Model NYR 112

No. 87250 - Special speaker for VW 1200 sedans and convertibles. Mounts in the dash grill provided. Complete with hardware, wiring and instructions.

- No. 87250 \$10.60 each

FADER CONTROL

Under-dash control for selecting either of 2 speakers or mixing them to any degree. Simply plug speaker cables into sockets provided. Complete with all hardware and instructions.

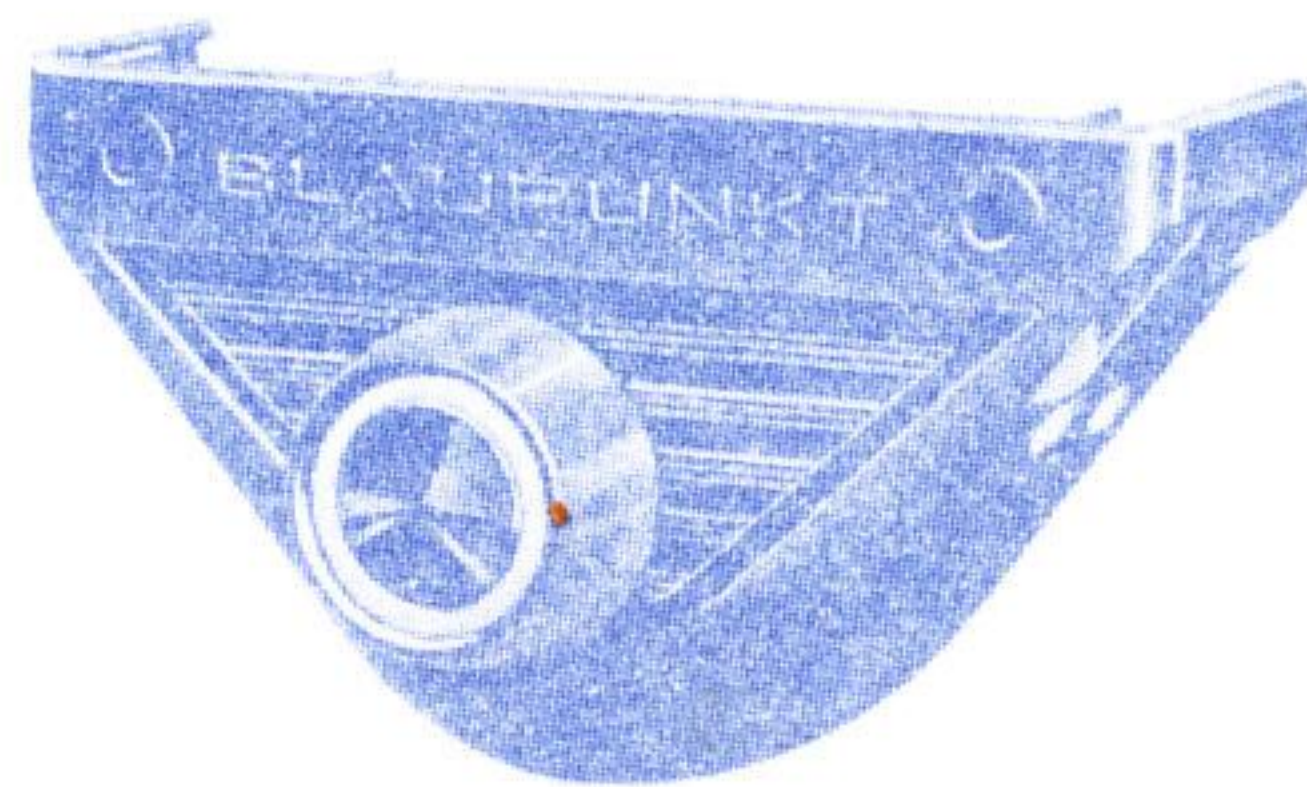

- No. 2215 \$10.95 each

SUPPRESSION KITS

Recommended to eliminate electrical interference created by the car itself.

- No. 87255 For all VW sedans, Ghias, Transporters \$ 8.90 each

Suppression kits for other cars available. Prices on request.

TO CARE FOR YOUR CAR

NEW WANNER HIGH PRESSURE GREASE GUN Made in Switzerland

For the full time mechanic or motorist! Over 5,000 psi pressure with one hand! For all equipment with Zerk or Alemite fittings. Connector tube rotates 360°, locks in any position. Fill the lubricant reservoir manually or with pressure equipment. Gives constant feed with all lubricants, including fibrous greases. Made of heavy non-corroding alloys. Ideal to supplement compressed air systems or for individual work. Fits VW fittings.

No. 315 ¼ pound capacity **\$12.00** each
No. 316 ¾ pound capacity **15.75** each

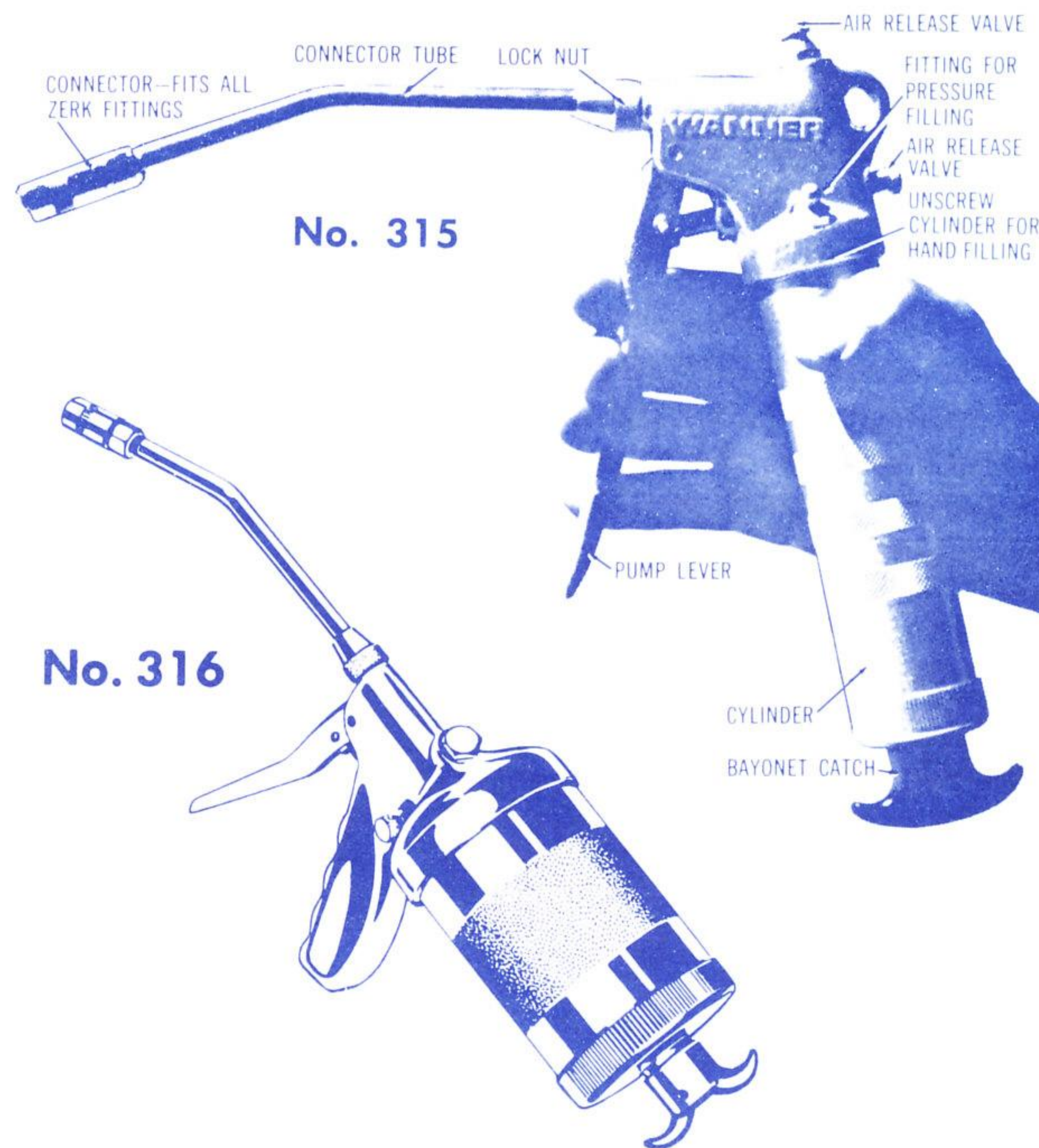

NEW E-Z SET TUNE-UP TOOL

Check points and plug gaps regularly for optimum performance and fuel economy with this tune-up kit. Points can be checked without rotating engine or dis-assembling distributor. Kit includes instructions. For Volkswagens, Porsche, Volvo, Taunus and Opel.

No. F-4 **\$ 1.49** each



MOLYKOTE FLUID CONCENTRATE

The Original World-Famous Molybdenum Disulfide Automobile Lubricant

Parts last longer. New parts wear in properly. Reduces frictional heat to eliminate tendency for oil to break down. Molykote Fluid Concentrate will blend with automotive lubricants, will not clog or be removed by filter. Add a 2 oz. tube to crankcase, standard transmission and rear axle lubricants.

2 oz. tube **\$ 1.25** each

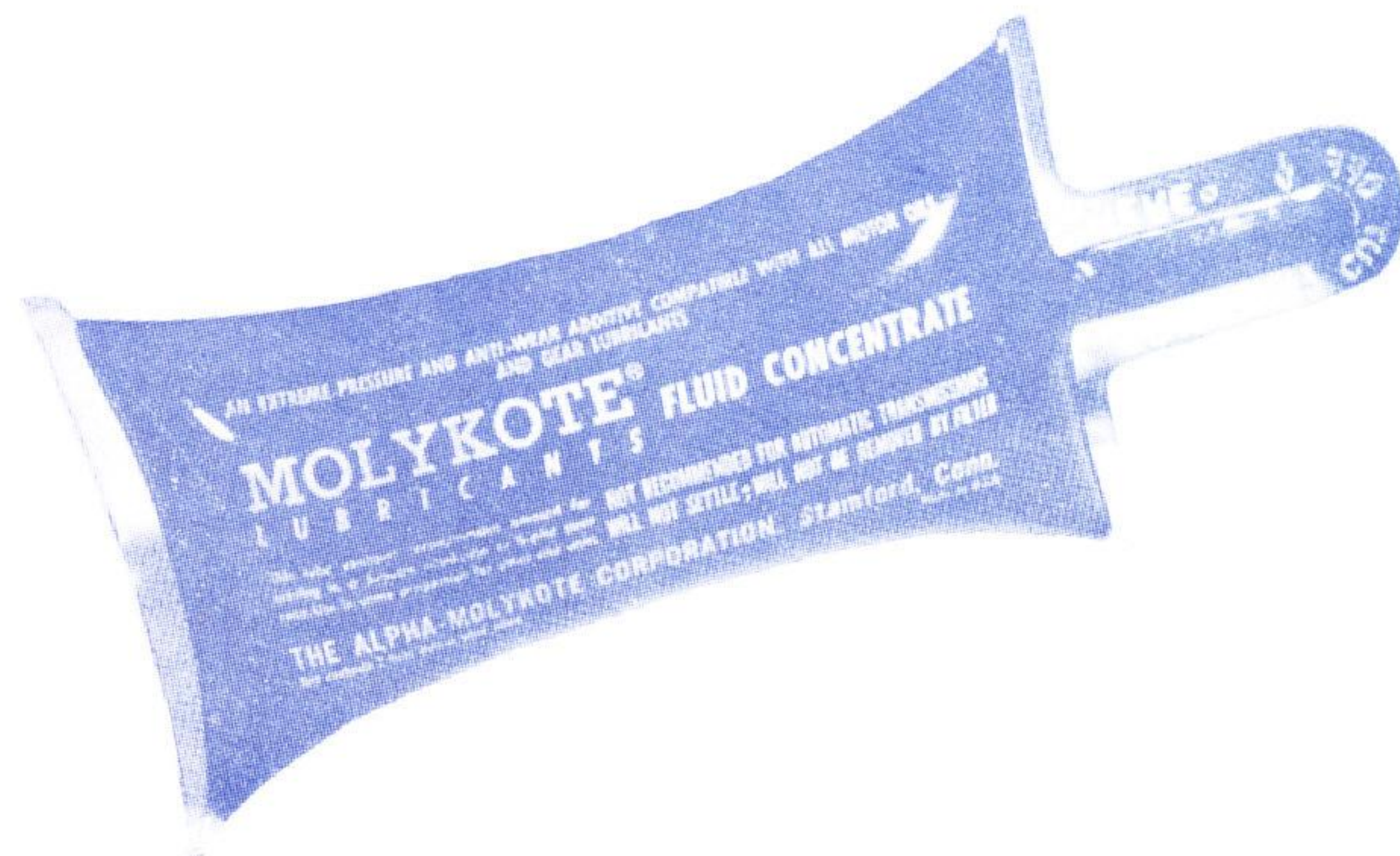

NEW PROFESSIONAL PENCIL TYPE TIRE GAUGE

Check tire pressure regularly and accurately. Incorrect pressure can increase tire wear and reduce fuel economy. Sturdy gauge has nylon indicating bar with etched markings for each pound of pressure. Checks 5 to 50 lbs. Pocket clip and deflating pin.

No. 509 **\$ 2.95** each

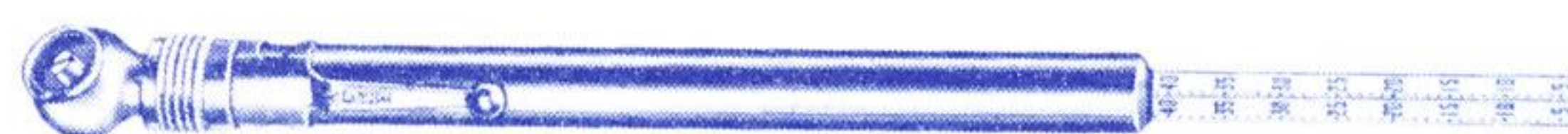

VALVE SEAT CUTTER KIT

CUTS THE HARDEST SEATS

Stops grinding dust from ruining cylinder walls and makes a perfect valve seat in just 5 quick turns!

The principle of the NEWAY VALVE SEAT CUTTER does away with old-fashioned grinding and lapping. A hand operated tool, it eliminates the need for high-speed electrical equipment and actually produces a far more accurate valve seat. Cutting head and blades are precision tooled instruments that save time and money with confidence that you've done a perfect job. You'll find it's easy to do one valve a minute.

The kit consists of one cutting head with 45° angle on one side and 15° angle on the other and one head with a 75° angle. Volkswagen pilots are provided in each kit. The serrated carbide blades cut very fast, so we provide a light-weight "T" handle socket wrench that allows the mechanic the feel of the cutter. Two or three pounds of pressure is all that is required. Fits all Volkswagen years, including the new 1500 series.

No. 202-AV

No. 202-B

Replacement Blades

\$53.25 complete kit

\$ 3.00 each

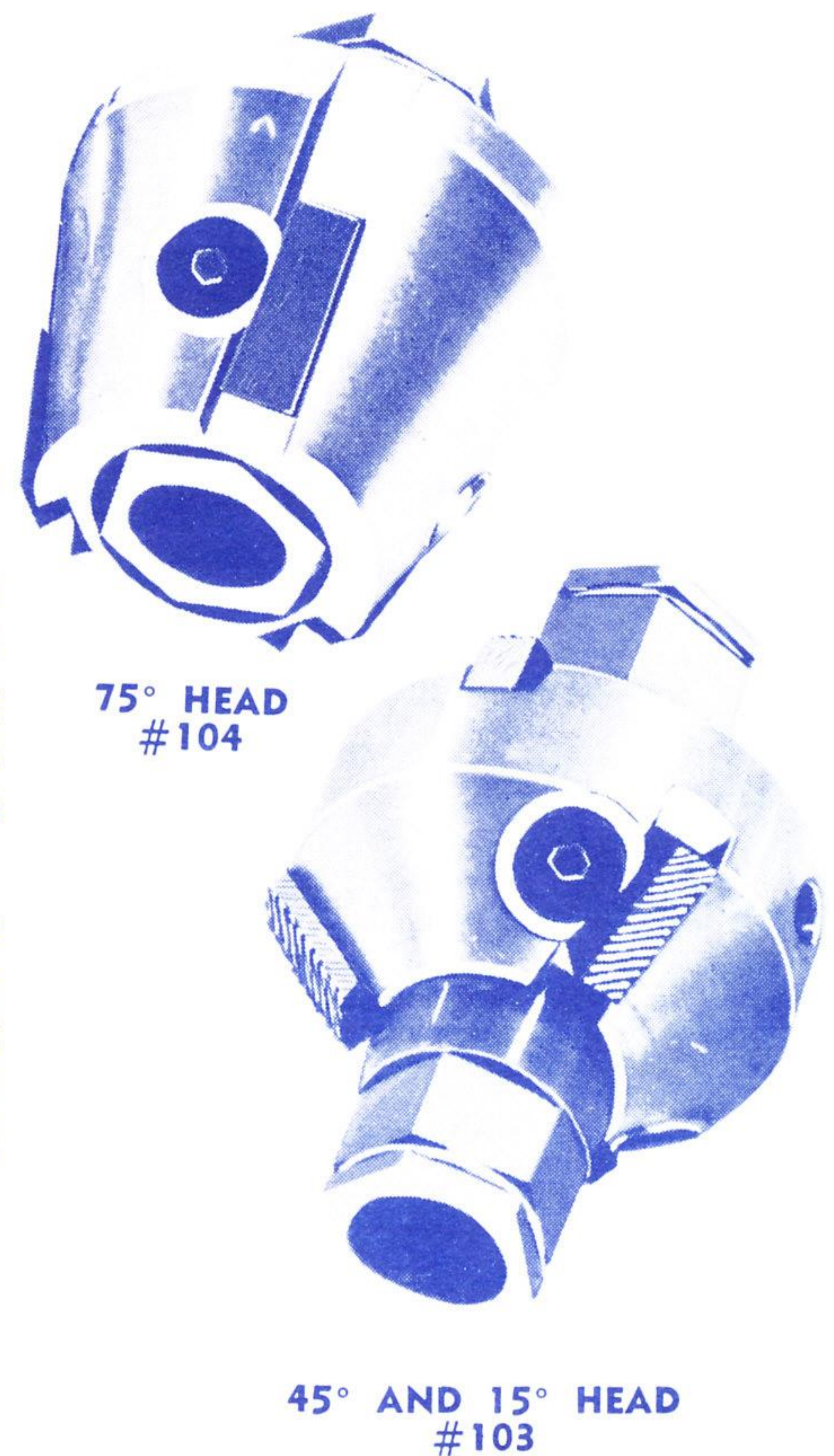

75° HEAD
#104

45° AND 15° HEAD
#103

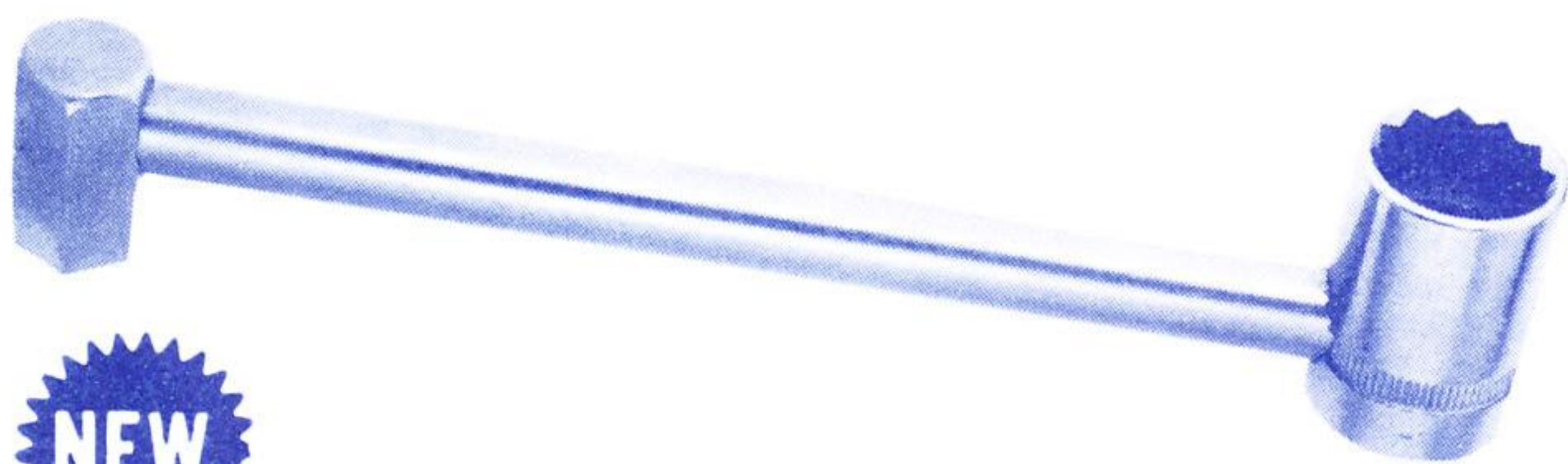

NEW

COMBINATION SERVICE WRENCH

Brand new design! Timesaver for professional mechanics as well as "Do-it-Yourselfers". One end for transmission plugs, the other end for crankcase plugs. For speedy work, keep this 2-in-1 wrench handy. Nickel plated. Life-time guarantee.

No. 400

\$ 3.95 each

BRAKE LINING AND GENERAL RIVETING SET

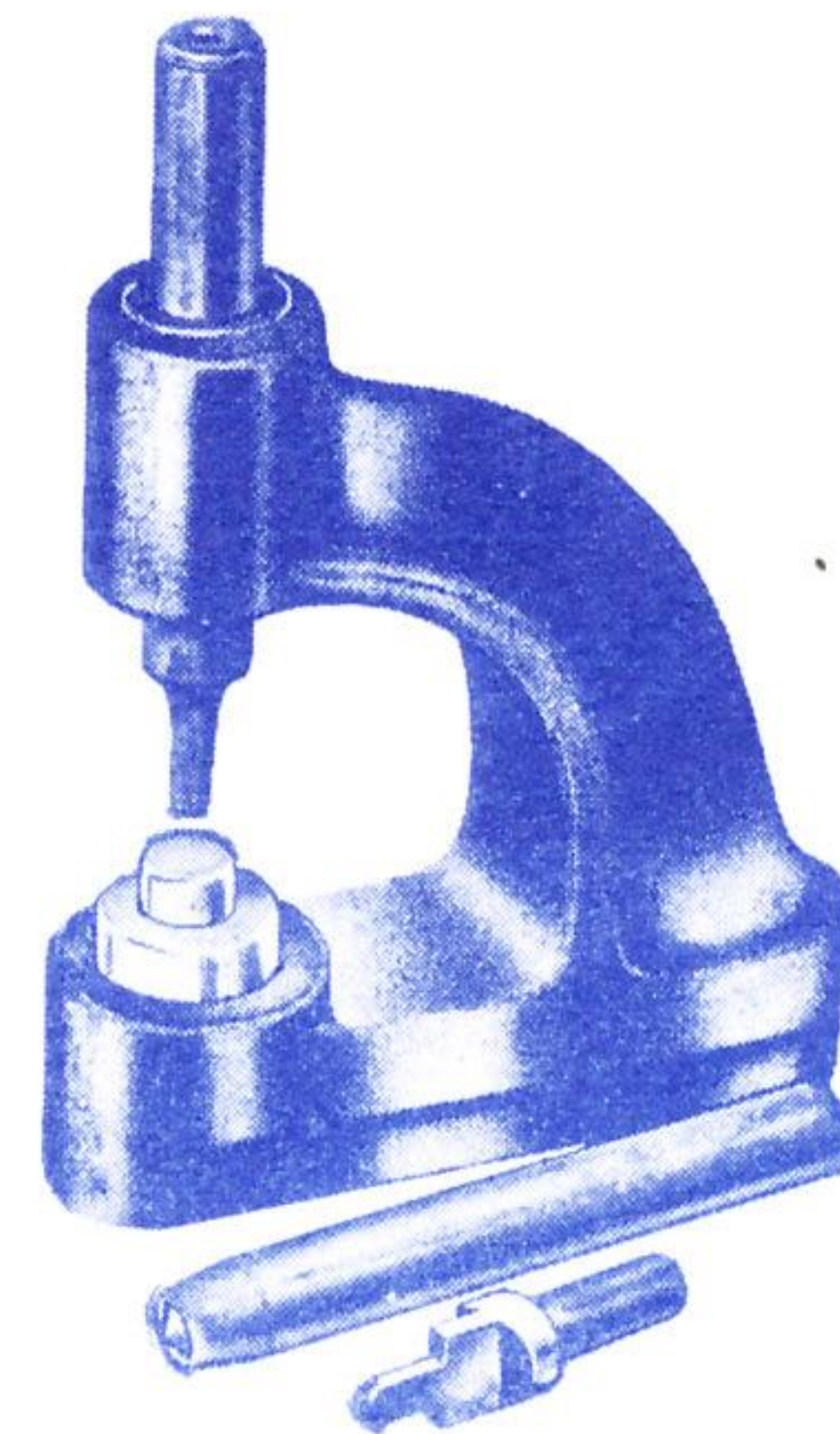

NO. 824

Designed especially to economically reline brakes; this set is a handy and useful tool on many other repair jobs around a household where the use of rivets is made to fasten leather, canvas, plastic and metal objects.

Set includes holding frame, anvil, combination drill and countersink tool, punch for removing rivets and tool for clinching rivets.

Hands are left free for work as frame can be held firmly in a vise. Height overall 3 1/2".

\$2.50

HEAVY DUTY HOSE CLAMP PLIER

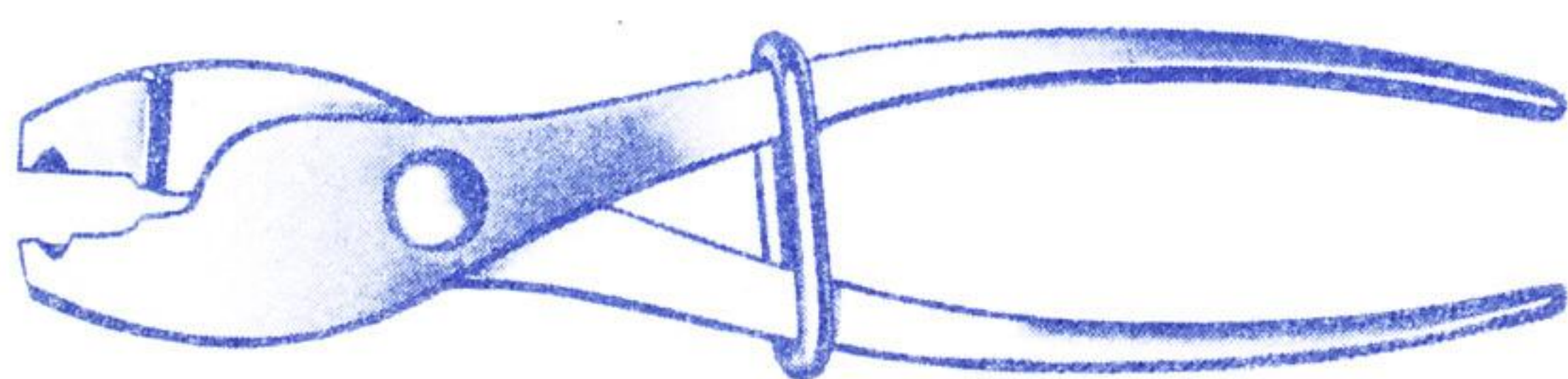

Heavy duty tool for removing and applying the new spring hose clamps which are now standard on many new automobiles. Recesses in the end and side of the jaws make it easy to get into tight places and assures positive gripping action. Slip ring on handle permits one to remove hand from plier to adjust hose. Fully chrome plated. Length 8". Capacity 0-1 3/4".

NO. 2141

\$2.75

METRIC TORQUE WRENCHES

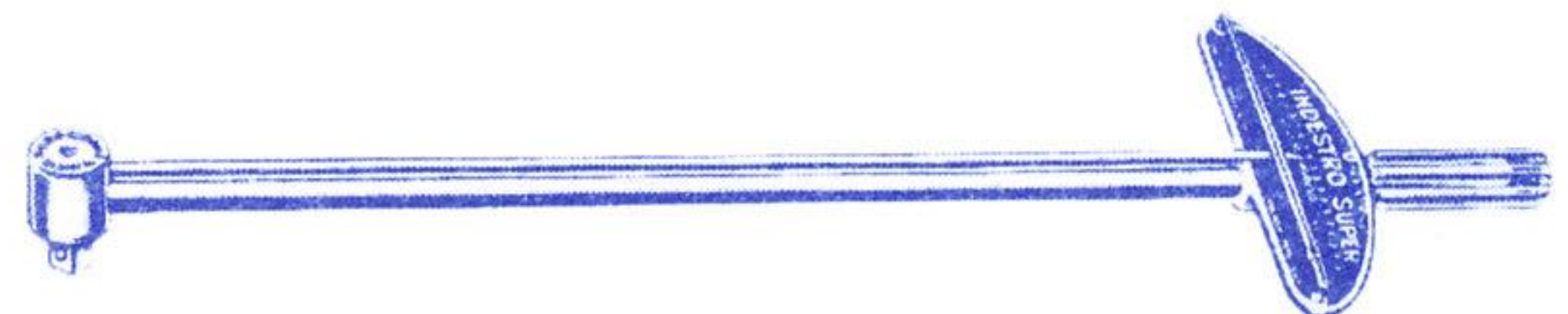

Eliminates the necessity of converting S.A.E. measurements into METRIC measurements.

Has range from 0 to 700 centimeter kilograms (cmkg.) and is graduated in 50 centimeter kilogram units. Length 13".

NO. 8072 3/8" (9.53 mm.) SQUARE DRIVE METRIC TORQUE WRENCH \$9.95

Has range from 0 to 20 meter kilograms (mkg.) and is graduated in 1 meter kilogram units. Length 18".

NO. 8074 1/2" (12.7 mm.) SQUARE DRIVE METRIC TORQUE WRENCH \$14.95

METRIC TOOLS

METRIC SOCKETS

CHROME ALLOY STEEL
1/2" SQUARE DRIVE



12 POINT

CHROME PLATED
FULLY POLISHED

No.	Metric Opening	Length MM.	Length Inches	Std. Pkg.	Unit Price
47010	10	38.10	1 1/2"	6	.79
47011	11	38.10	1 1/2"	6	.79
47012	12	38.10	1 1/2"	6	.80
47013	13	38.10	1 1/2"	6	.83
47014	14	39.69	1 9/16"	6	.88
47015	15	39.69	1 9/16"	6	.91
47016	16	39.69	1 9/16"	6	.92
47017	17	39.69	1 9/16"	6	.93
47018	18	39.69	1 9/16"	6	.93
47019	19	39.69	1 9/16"	6	.95
47020	20	41.28	1 5/8"	6	1.00
47021	21	41.28	1 5/8"	6	1.02
47022	22	42.07	1 21/32"	6	1.10
47023	23	42.07	1 21/32"	6	1.15
47024	24	42.07	1 21/32"	6	1.17
47025	25	42.07	1 21/32"	6	1.25
47026	26	42.07	1 21/32"	6	1.27
47027	27	42.07	1 21/32"	6	1.35
47028	28	42.07	1 21/32"	6	1.38
47029	29	42.07	1 21/32"	6	1.48
47030	30	42.07	1 21/32"	6	1.54
47032	32	42.07	1 21/32"	6	1.59

13 PIECE SET



This tray containing thirteen popular metric sockets provides an ideal method of separation of your metric sizes from inch sizes. Tray can be hooked on edge of tool box or tote tray. Movable handle prevents spilling sockets. Sizes—10 mm, 11 mm, 12 mm, 13 mm, 14 mm, 15 mm, 16 mm, 17 mm, 18 mm, 19 mm, 20 mm, 21 mm, 22 mm.

NO. 7880MM **\$12.50** per set postpaid

8 Piece Vest Pocket Socket Set

CONTENTS

5 mm. 6 Pt. Socket	9 mm. 6 Pt. Socket
6 mm. 6 Pt. Socket	10 mm. 6 Pt. Socket
7 mm. 6 Pt. Socket	11 mm. 6 Pt. Socket
8 mm. 6 Pt. Socket	4" L Handle



NO. 350MM **\$1.95** each postpaid

CHROME ALLOY STEEL METRIC SOCKETS—3/8" SQ. DR.

No.	Metric Opening	Length Inches	Std. Pkg.	Unit Price
46007	7MM 6 Pt.	1 1/16"	6	.69
46008	8MM 6 Pt.	1 1/16"	6	.69
46009	9MM 6 Pt.	1 1/16"	6	.69
46010	10MM 12 Pt.	1 1/16"	6	.69
46011	11MM 12 Pt.	1 1/16"	6	.69
46012	12MM 12 Pt.	1 1/16"	6	.69
46013	13MM 12 Pt.	1 1/16"	6	.72
46014	14MM 12 Pt.	1 1/8"	6	.75
46015	15MM 12 Pt.	1 1/8"	6	.78
46016	16MM 12 Pt.	1 1/8"	6	.81
46017	17MM 12 Pt.	1 1/8"	6	.85
46018	18MM 12 Pt.	1 1/8"	6	.88
46019	19MM 12 Pt.	1 1/8"	6	.90

SQUARE DRIVE



Federal Spec: GGG-W-641b

Check the outstanding features—designed and engineered by *Professional* men for *Professional* men.

- Patented form fit finger tip reversing cap—no rough edges to irritate the hand when palming.
- Ratchet will not reverse when palmed.
- Compact round head provides ease and speed when working in restricted places—no blind corners.
- Fifty-two teeth guarantees fast, close, positive ratcheting action—a new "bite" every 7°.
- The newly designed Oval Grip handle affords the user comfort and greater "knuckle clearance".
- Tough chrome alloy steel—torque tested far beyond government specifications.

Fully chrome plated. Length 10 1/2".

NO. 3277 1/2" SQUARE DRIVE **\$7.25**

NO. 2777 3/8" SQ. DR. **\$6.25**

11 PIECE SET

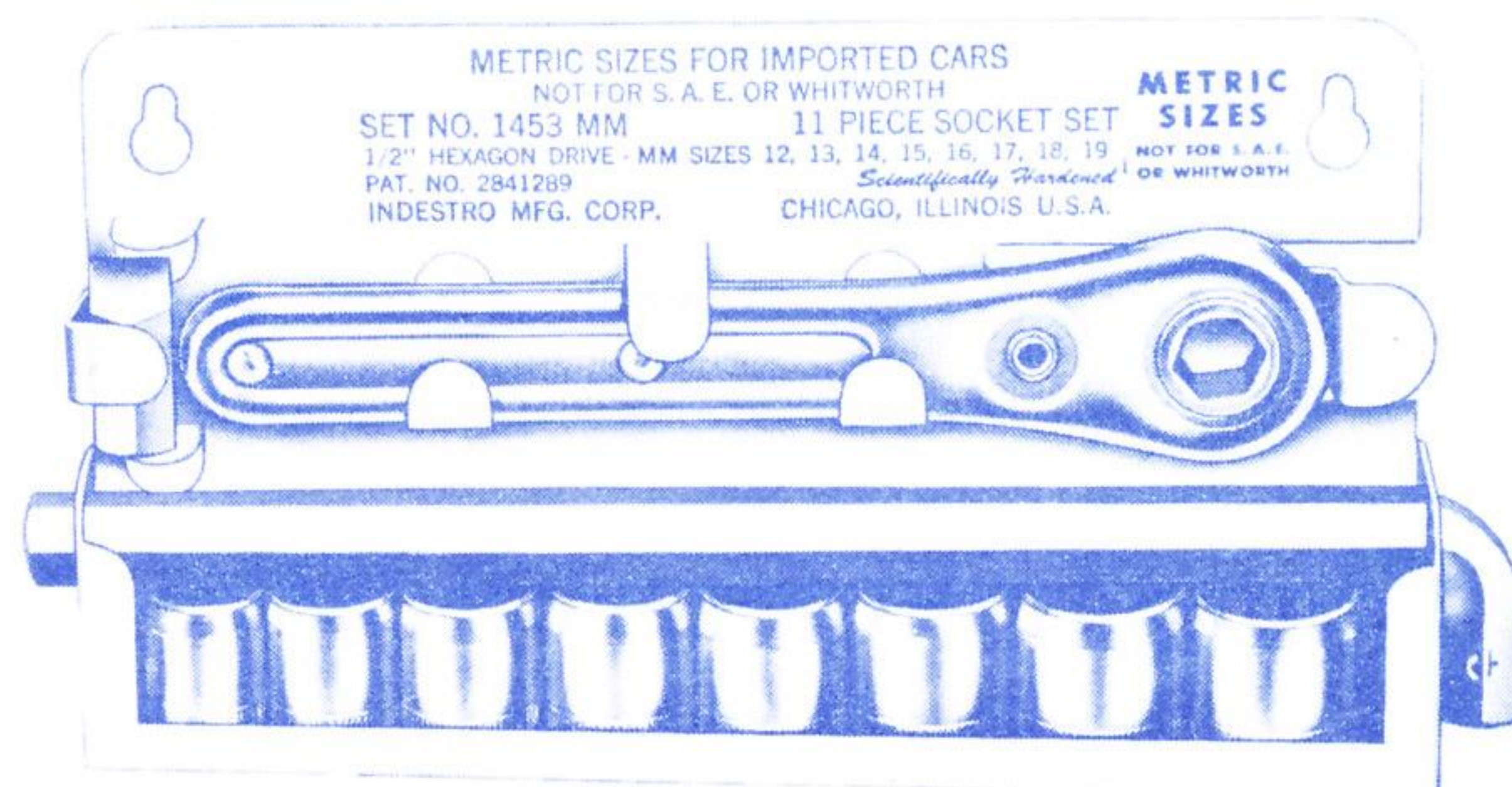

CONTENTS

12 mm. 12 Pt. Socket	17 mm. 12 Pt. Socket
13 mm. 12 Pt. Socket	18 mm. 12 Pt. Socket
14 mm. 12 Pt. Socket	19 mm. 12 Pt. Socket
15 mm. 12 Pt. Socket	6 3/4" Ratchet
16 mm. 12 Pt. Socket	9 3/16" L Handle

Screw Driver Adaptor

NO. 1453MM **\$6.95** each postpaid

METRIC OPEN END WRENCHES

Select Steel—Engineer Type

Chrome Plated

Polished Heads



Needed for the repair or adjustments on foreign cars by car owners and mechanics. These wrenches are drop forged and scientifically heat treated. Clean, accurate broaching of sizes assure exact fit. Openings are at a 15° angle to body permitting turning of nuts or bolts with a swing of only 30°.

No.	Metric Opening	Length MM.	Length In.	Head Thick. MM.	Head Thick. In.	Std. Pkg.	Unit Price
40607	6 x 7	82.55	3 1/4"	3.57	9/64"	6	.56
40809	8 x 9	95.25	3 3/4"	3.97	5/32"	6	.56
41011	10 x 11	114.30	4 1/2"	4.76	3/16"	6	.65
41213	12 x 13	138.11	5 1/16"	5.16	13/64"	6	.76
41415	14 x 15	163.51	6 1/16"	5.95	15/64"	6	.94
41617	16 x 17	163.51	6 7/16"	5.95	15/64"	6	.96
41819	18 x 19	185.74	7 5/16"	7.14	9/32"	6	1.06
42022	20 x 22	209.55	8 1/4"	7.94	5/16"	6	1.52
42123	21 x 23	228.60	9"	9.53	3/8"	6	1.88
42426	24 x 26	228.60	9"	9.53	3/8"	6	1.94

6 PIECE SET



This six piece set contains twelve of the most popular metric openings. Range 8 mm to 19 mm inclusive.

NO. 941-6MM

\$6.95

10 PIECE SET

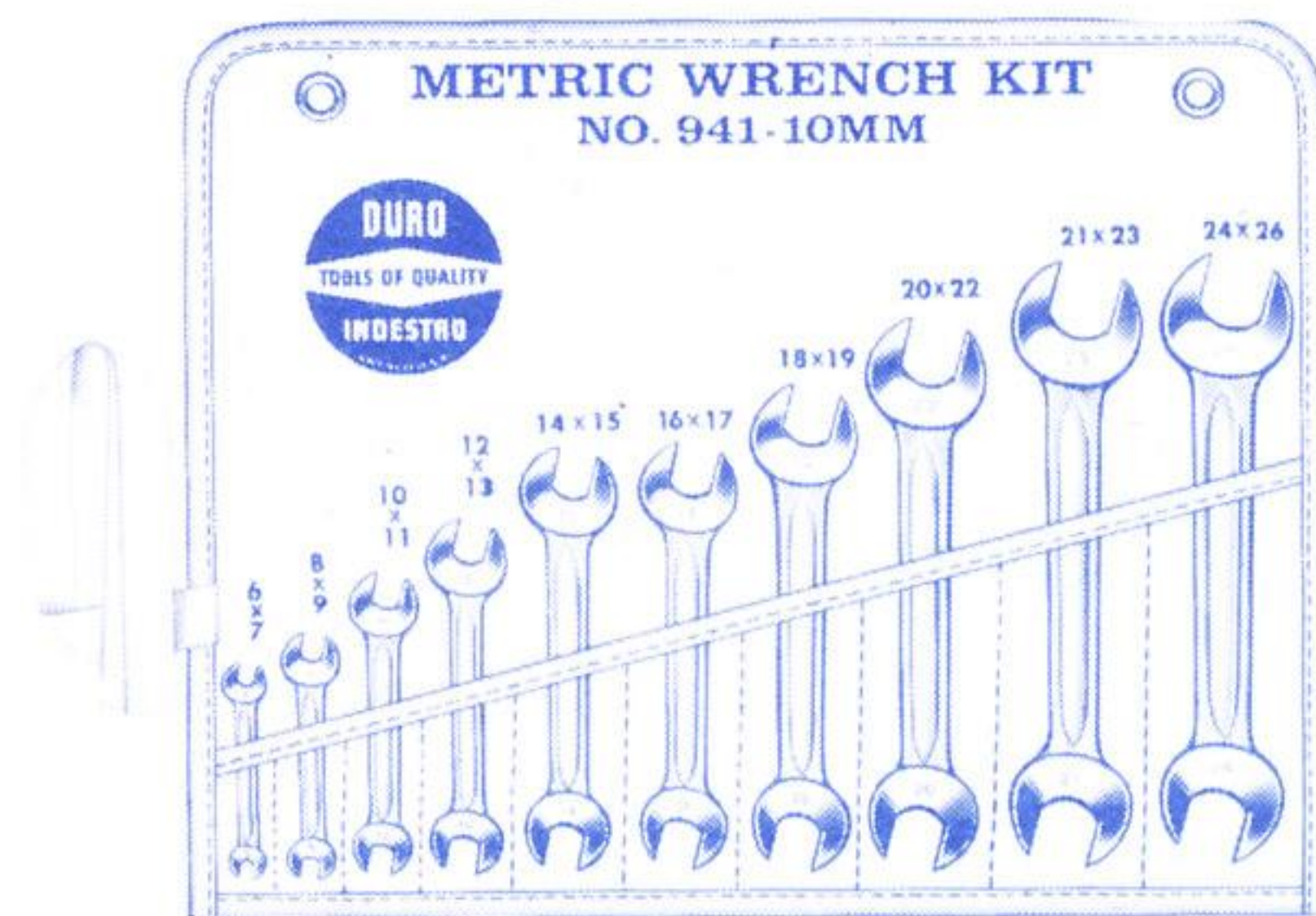

A complete set of metric open end wrenches in a vinyl plastic kit. Range 6 mm to 26 mm inclusive.

NO. K138

KIT

\$12.50 per set

METRIC COMBINATION WRENCHES



All of the features of the box and open end wrenches are combined in one wrench. Both ends have same size openings. Box end is offset 10° for clearance and the open end is at a 15° angle for positive nut turning in restricted space. Forged from CHROME ALLOY STEEL, each wrench is brightly chrome plated.

Box end of No. 44009 is 6 point, all other wrenches are 12 point.

No.	Size	Length MM.	Length In.	Open Head Thick. MM.	Open Head Thick. In.	Std. Pkg.	Unit Price
44009	9MM	120	4 3/4"	5.16	13/64"	6	1.04
44010	10MM	120	4 3/4"	5.16	13/64"	6	1.15
44011	11MM	131	5 3/16"	5.54	7/32"	6	1.25
44012	12MM	146	5 3/4"	5.94	15/64"	6	1.35
44013	13MM	146	5 3/4"	5.94	15/64"	6	1.35
44014	14MM	162	6 3/8"	6.35	1/4"	6	1.50
44015	15MM	162	6 3/8"	6.35	1/4"	6	1.52
44016	16MM	179	7 1/16"	7.14	9/32"	6	1.56
44017	17MM	179	7 1/16"	7.14	9/32"	6	1.56
44018	18MM	194	7 11/16"	7.51	19/64"	6	1.85
44019	19MM	209	8 1/4"	7.92	5/16"	6	1.85
44020	20MM	209	8 1/4"	7.92	5/16"	6	2.04
44021	21MM	267	10 1/2"	8.71	11/32"	6	2.38
44022	22MM	288	11 3/8"	9.12	23/64"	6	2.75

7 PIECE SET

Set contains seven popular size metric combination wrenches as follows; 9MM, 10MM, 11MM, 12MM, 14MM, 17MM and 19MM.

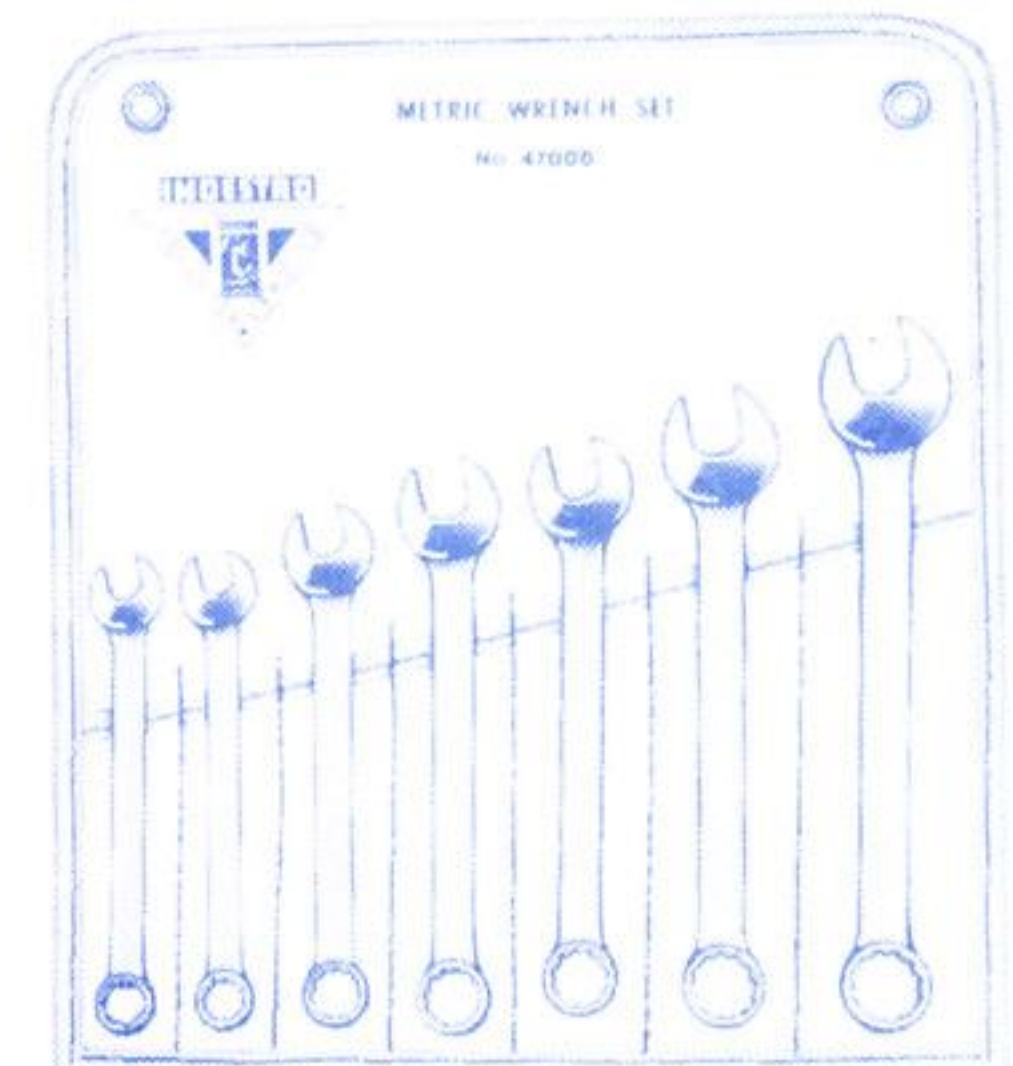

NO. 47000-1 7 PIECE SET

\$12.95

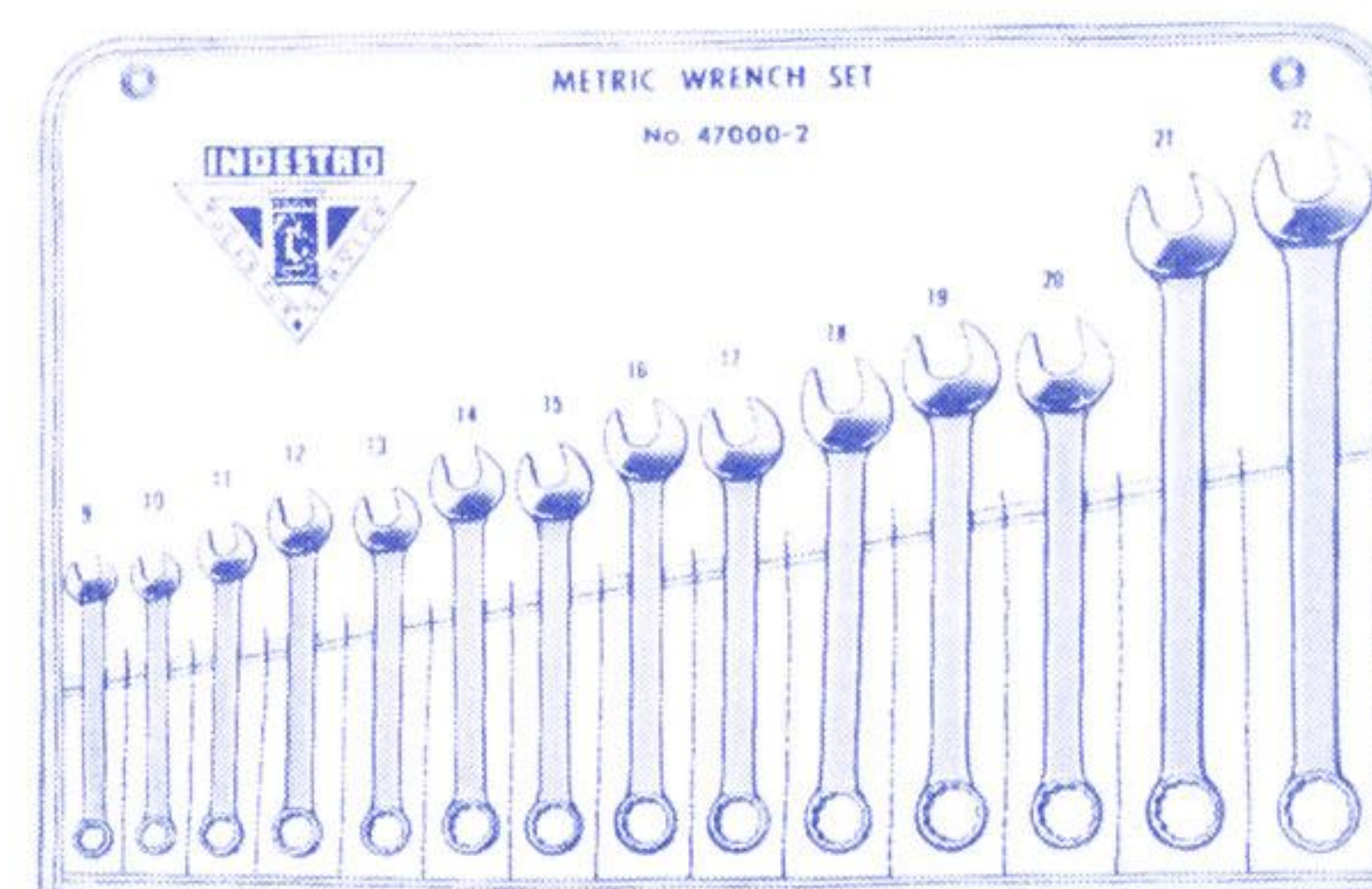

NO. 47000-2 14 PIECE SET

\$26.95

14 PIECE SET

A complete set of metric combination wrenches from 9MM to 22MM inclusive.

811 PROSPECT AVENUE

POLY PAD IMPORTS

CLEVELAND, OHIO 44115

Accessories for the Volkswagen Owner

THE LIBRARY

LATEST EDITIONS BY FLOYD CLYMER

HOW TO DRIVE A VOLKSWAGEN

This wonderful book contains detailed instructions on the proper handling of your car. Get this latest revised edition, which includes specifications.

\$ 3.00 each

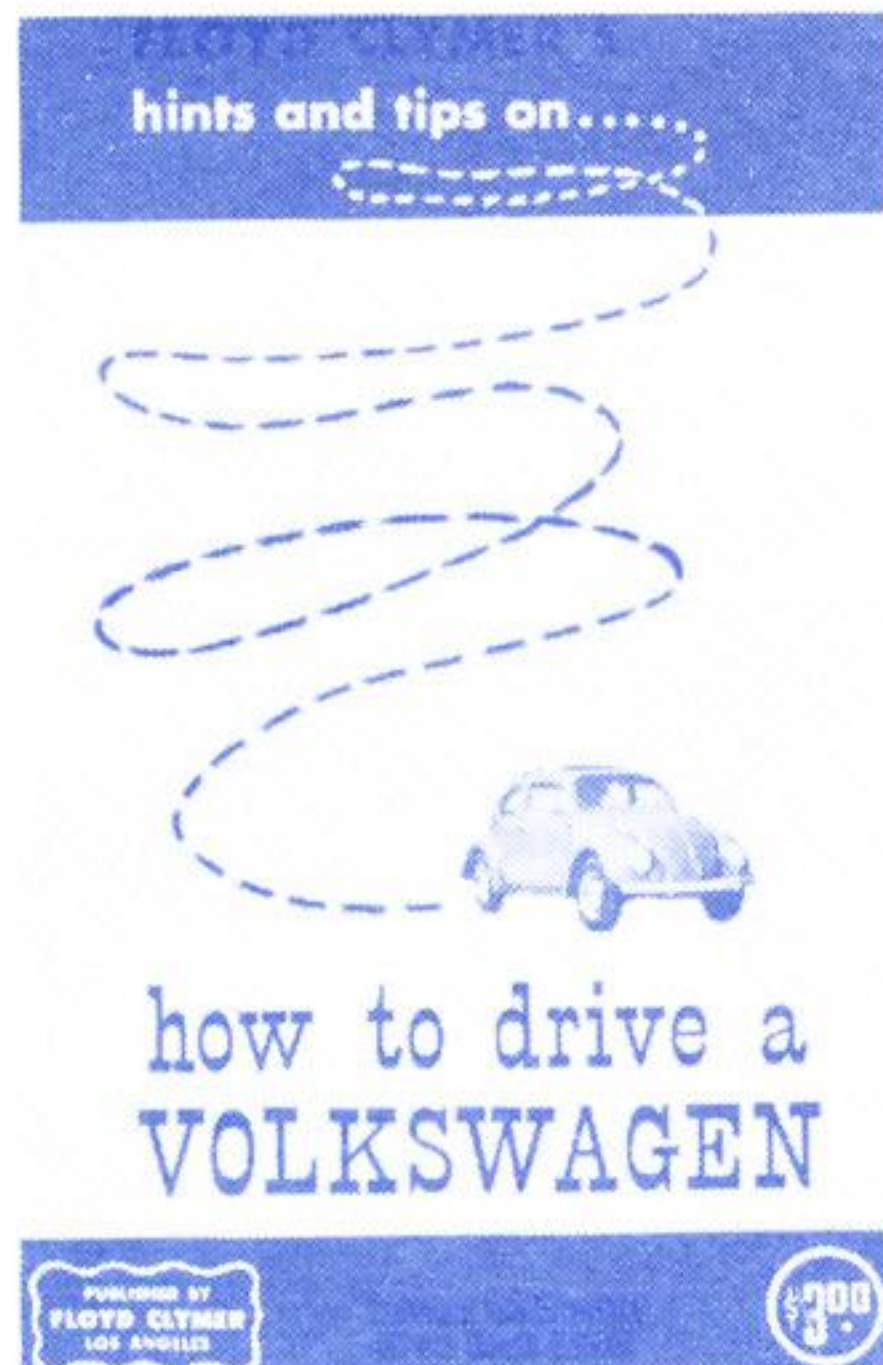

VW 1500

The newest Floyd Clymer reference book gives complete information on the maintenance and repair of the new VW 1500 models. Contains vital information on servicing the entire 1500 series including the 1500 S. This handbook gives you information on all years from the earliest models to present date.

\$ 4.00 each

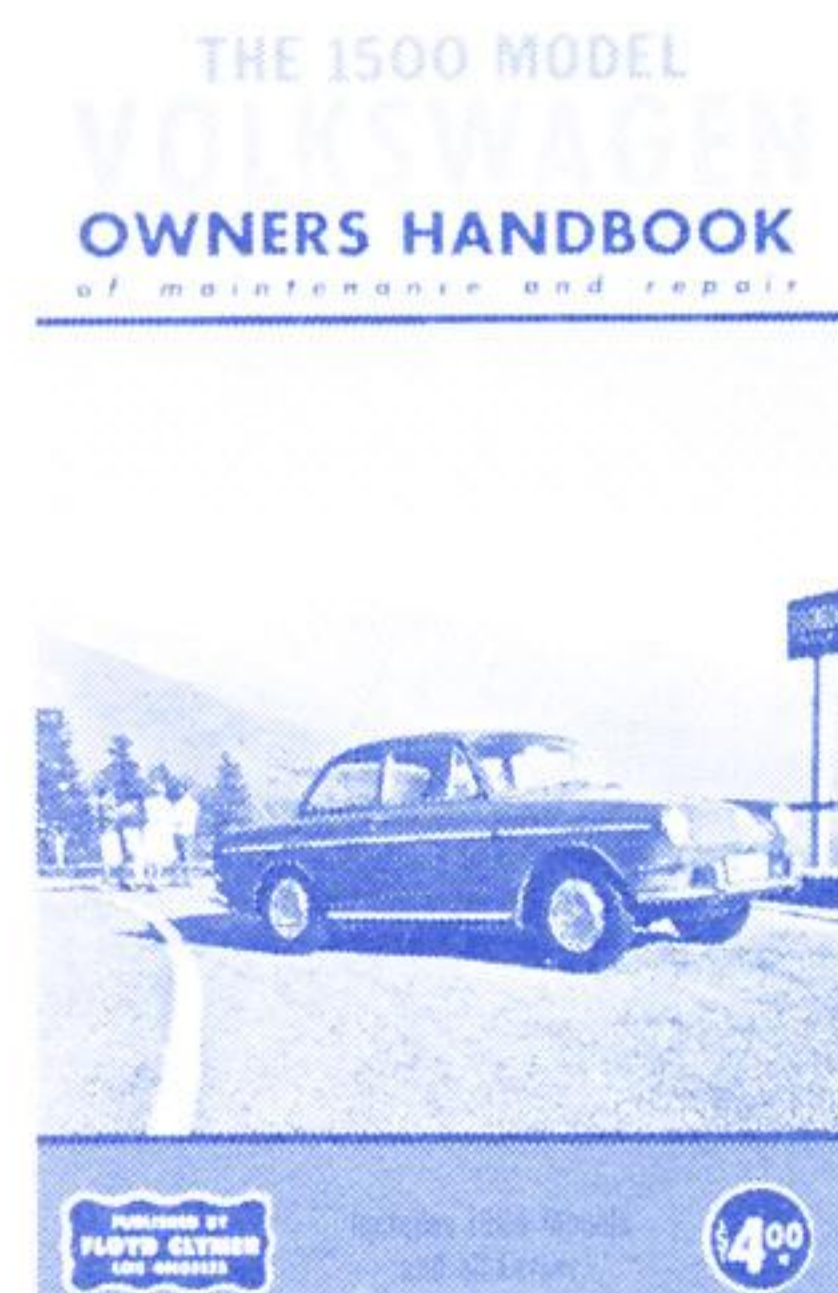

VOLKSWAGEN OWNERS HANDBOOK

The latest and greatest edition of Floyd Clymer's famous series. Contains valuable information on latest models, including the VW 1500.

\$ 3.00 each

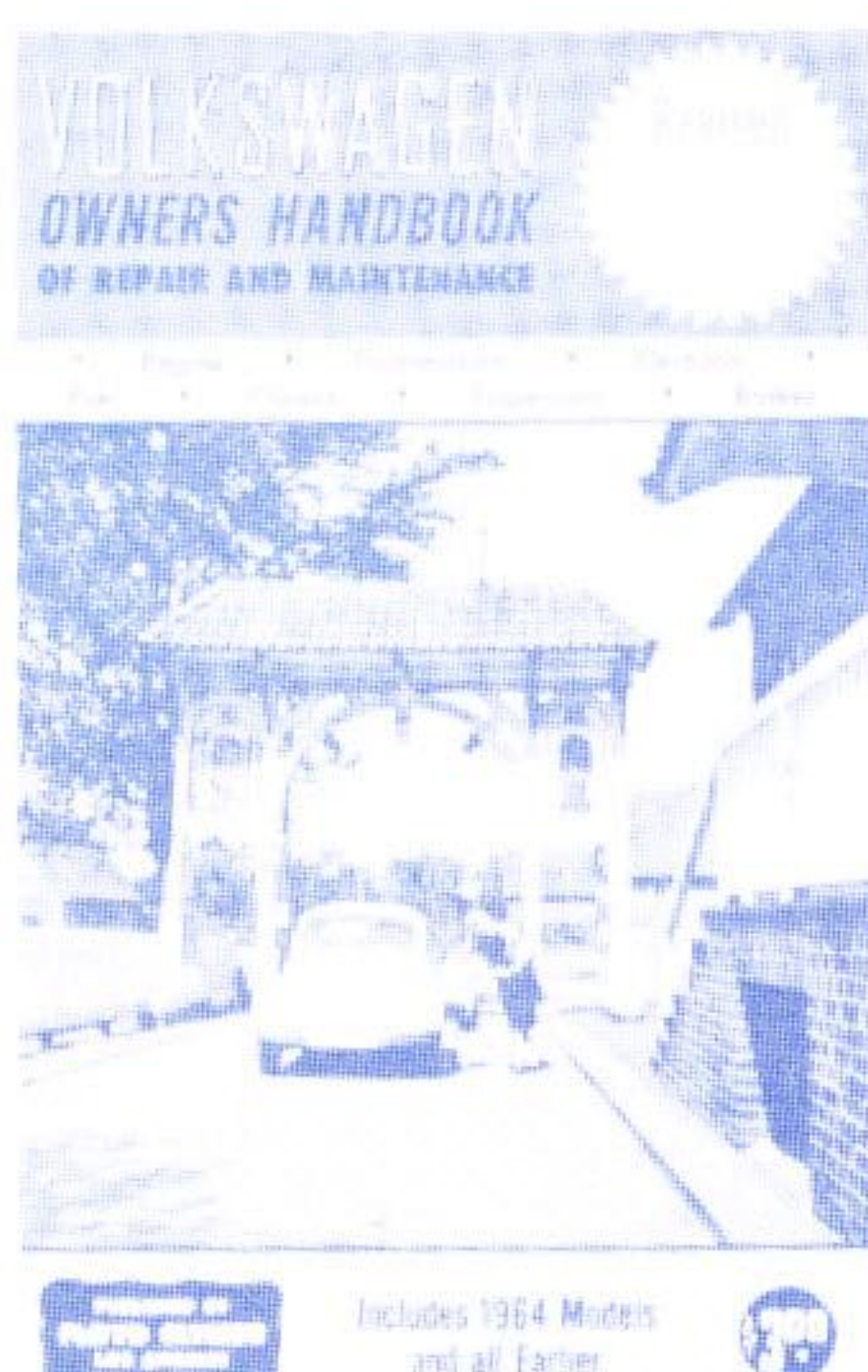

LATEST EDITIONS BY HENRY ELFRINK

MAKING THE VOLKSWAGEN GO

This beautifully hardbound edition tells all about speed tuning and power equipment for the VW. A must for your collection.

\$ 5.00 each

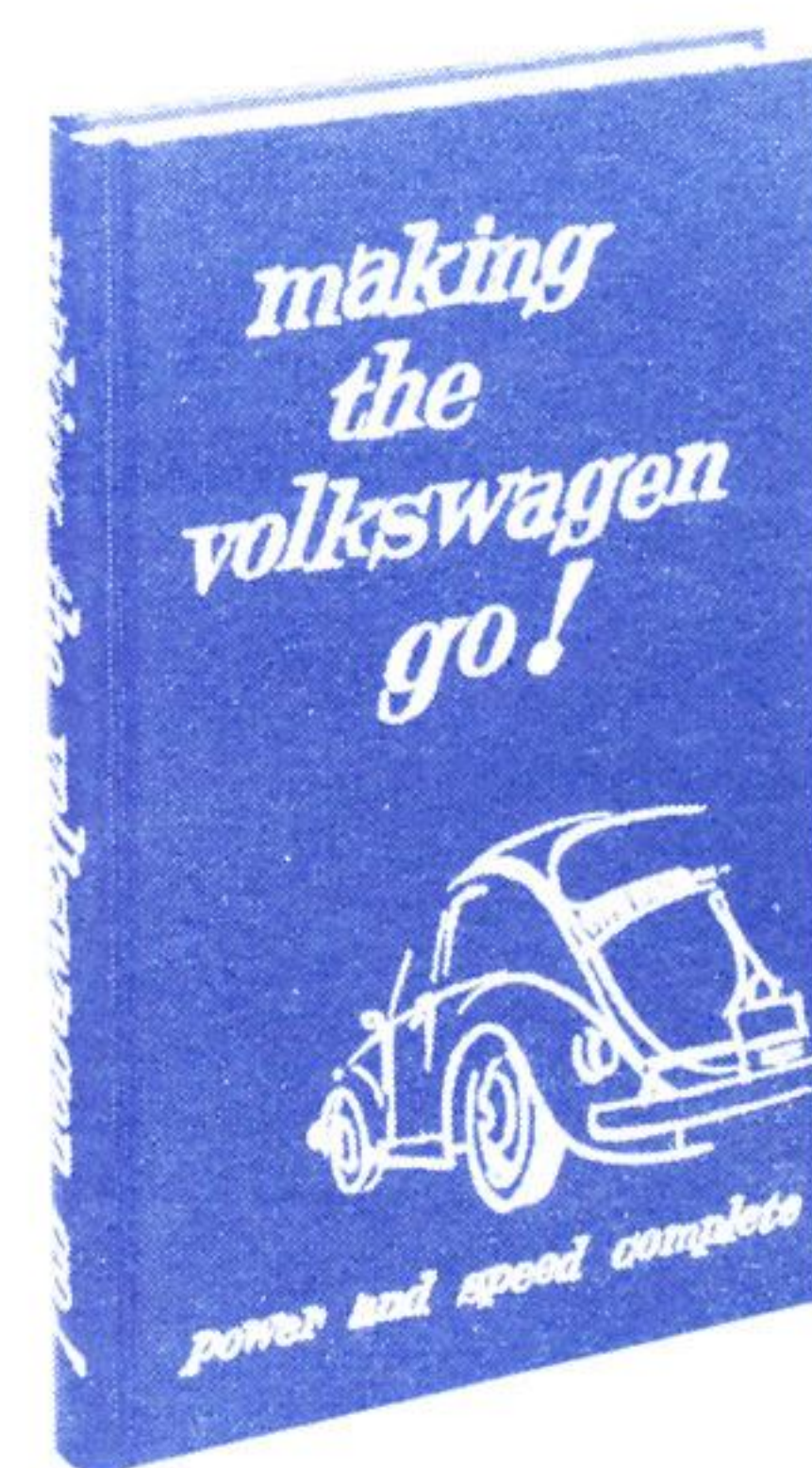

SOUPING THE VOLKSWAGEN

Contains valuable trouble shooting information and many preventive maintenance tips. Written by Dick Morgan, this authoritative publication will thrill all Volkswagen owners who are interested in getting more get-up-and-go.

\$ 3.00 each

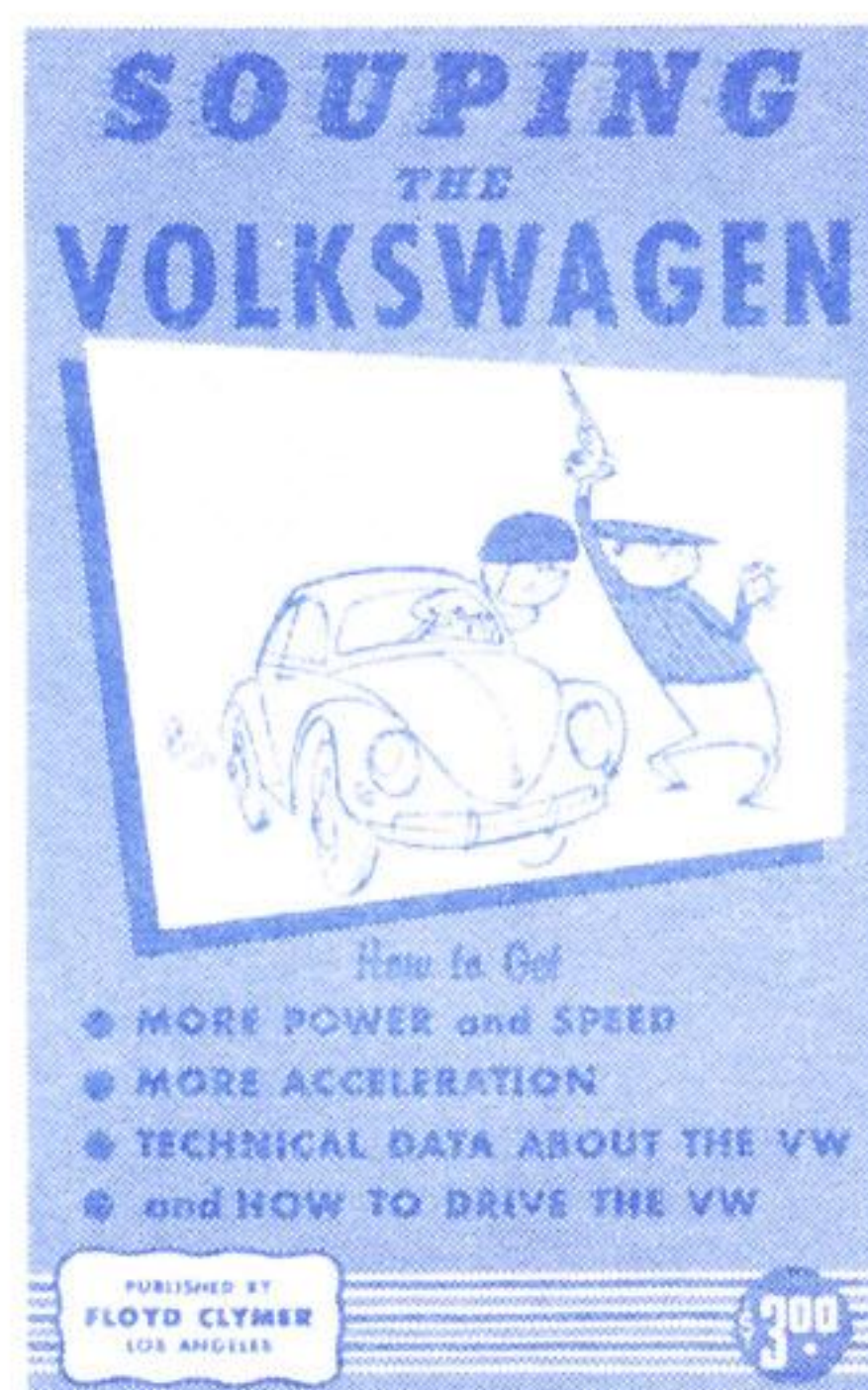

VOLKSWAGEN TECHNICAL MANUAL

A 224-page publication containing detailed drawings and photos on the entire workings of the Volkswagen. Truly the last word on "All About the Volkswagen."

\$ 3.50 each



TRANSPORTER OWNERS HANDBOOK

The hundreds of illustrations and explanations in this 152 page book can save the transporter owner hundreds of dollars in costly repairs. A must for the owner who wants additional miles from his bus.

\$ 3.00 each

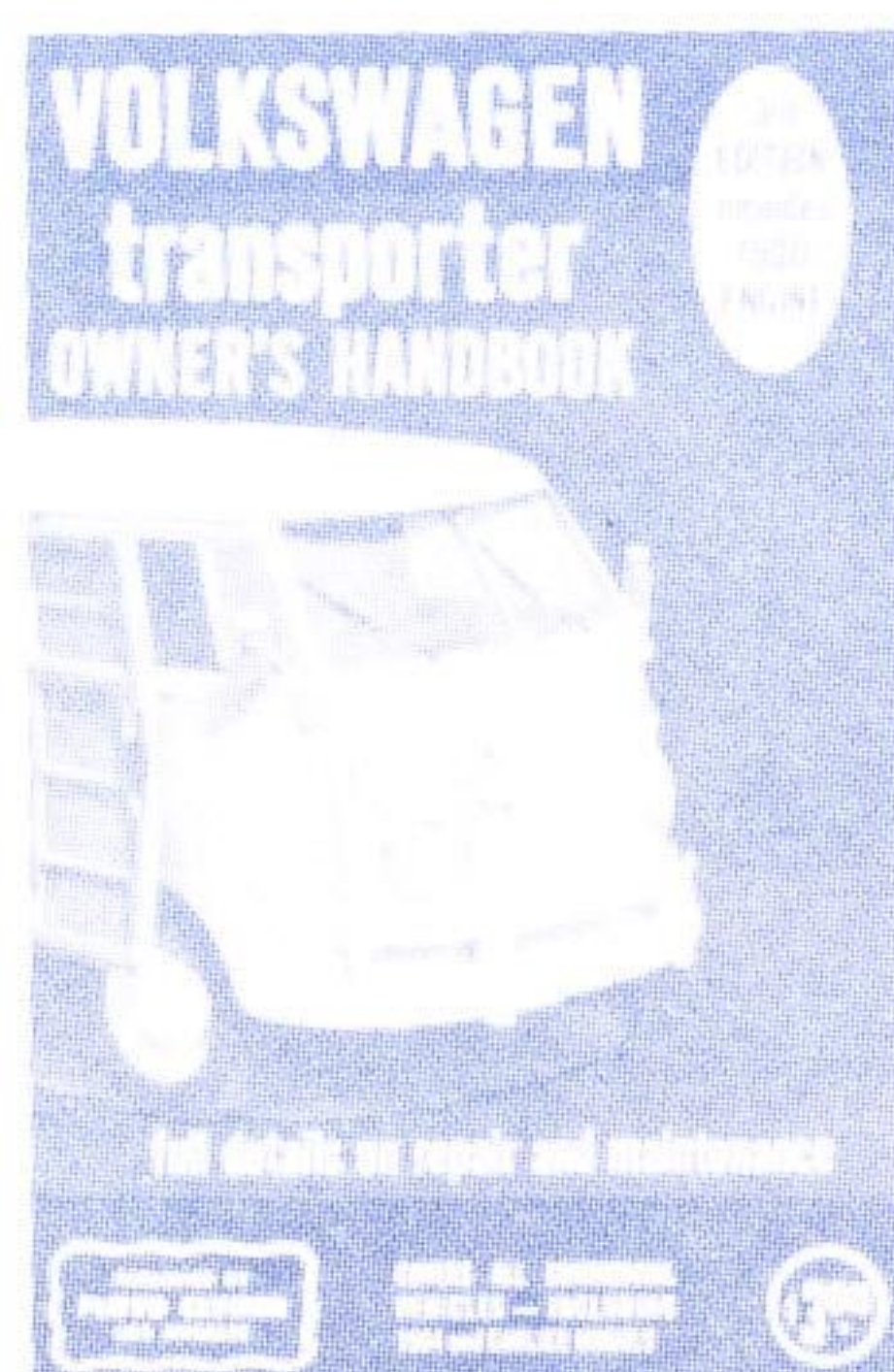

PORSCHE TECHNICAL MANUAL

Contains the complete specifications on repair and maintenance. Valuable help for the mechanic as well as the advanced owner.

\$ 5.00 each



VOLKSWAGEN BEER STEINS

The old world art of hand-crafting beer steins is passed down from father to son, from generation to generation. Beer steins are made in the same way today as they were 400 years ago. We have located a fine craftsman in Germany who is making, for us exclusively, a beautiful multi-colored stein, hand painted, featuring the Wolfsburg Crest! Available in a one liter stein that holds over a quart of your favorite brew or in the half liter size. Complete with authentic hinged metal cap. Clubs please note: special orders with club emblems can be accepted. Please write for quotations and further information.



No. 265	1 Liter	\$10.95
No. 266	½ Liter	\$ 7.95



VOLKSWAGEN DRINKING GLASSES

A proud possession for the VW owner and a perfect year 'round gift. Manufactured by Libbey exclusively for Poly Pad Imports. Set of 6 glasses, each decorated with 6 Volkswagen models: 1200 sedan, convertible, new 1500, Karmann-Ghia, 1500 Variant and Micro Bus. 3 red and 3 green glasses in each set. Guaranteed not to chip or peel. Safety edge and other high quality features.

No. G-6

\$ 6.00 per set of 6

811 PROSPECT AVENUE

POLY PAD IMPORTS

CLEVELAND, OHIO 44115

Accessories for the Volkswagen Owner



POLY PAD PRESENTS

BLAUPUNKT CAR RADIOS

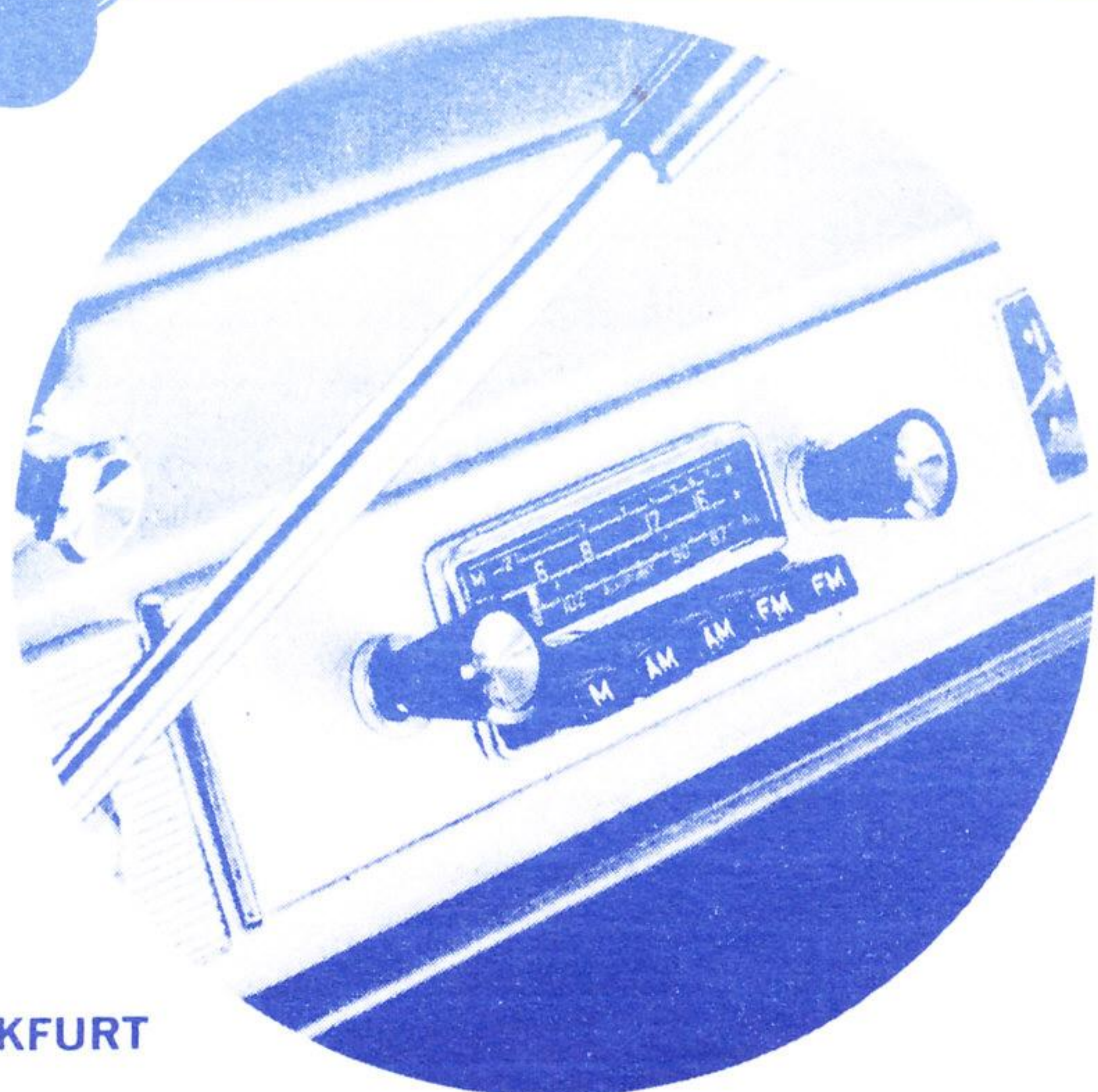

FRANKFURT

A top quality transistor, FM/AM/Marine band, push button radio with high sensitivity on all 3 bands. Excellent noise limiter, automatic volume control, voltage and polarity converter for universal use, powerful push-pull output stages and variable tone control make this a radio experience to listen to.

109.95

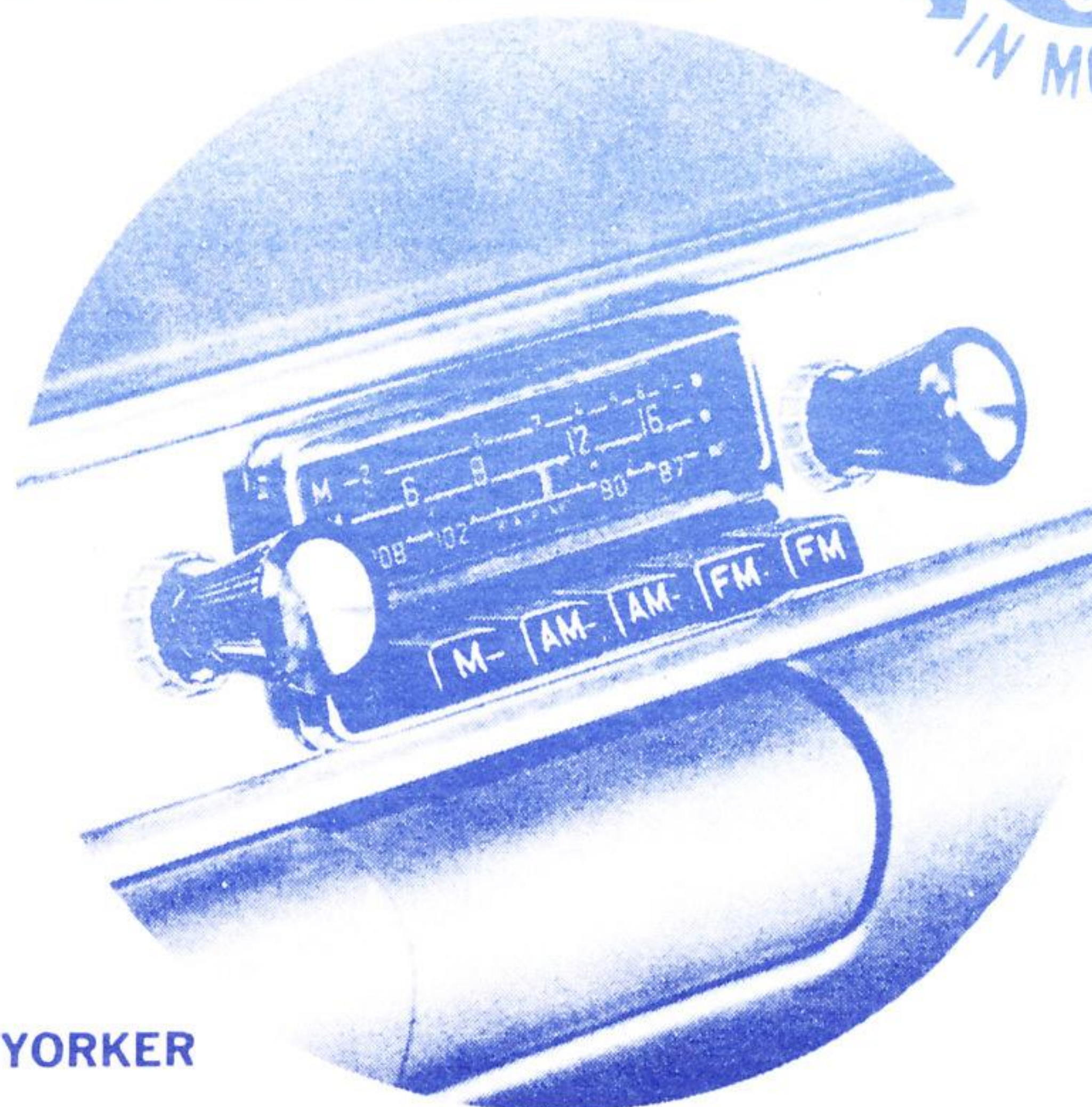

NEW YORKER

The top of the line. An FM/AM/Marine band push button radio, the New Yorker gives high sensitivity on all 3 bands. At the push of a knob it automatically seeks out the station of your choice on all wave bands. Excellent noise limiter, automatic volume control, voltage and polarity converter for universal use, powerful transistor push-pull output stages and variable tone control make this a radio experience to listen to.

163.95



MANHATTAN

An all transistor, compactly designed, AM model. This manual tuning radio combines high tonal qualities and extreme sensitivity. It has a powerful output stage and is only 2 3/8" in height. Other features include its universal application (polarity and voltage conversion), automatic volume control and push button tone control.

45.95

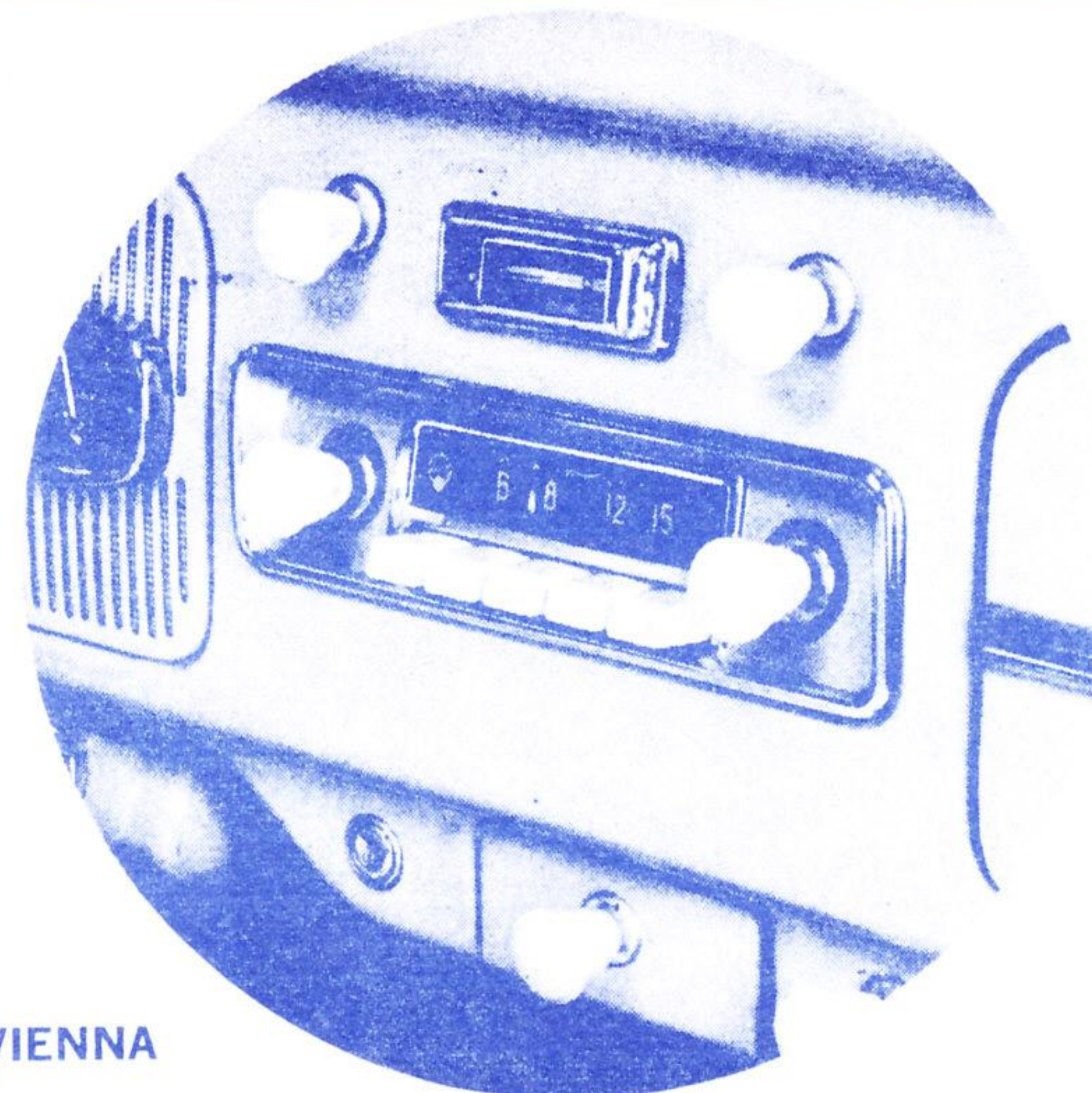

VIENNA

An all transistor deluxe push button AM radio. Automatic volume control assures steady fade-free reception. It has a powerful output stage and is only 2 3/8" in height. Other features include variable tone control and voltage and polarity conversion.

63.50

BLAUPUNKT CAR RADIO

INSTALLATION KIT LIST PRICES

CAR	MANHATTAN AM-MANUAL	VIENNA AM PUSH-BUTTON	FRANKFURT AM/FM/MB	NEW YORKER AM/FM/MB SIGNAL-SEEKER	DERBY AM/FM/SW/MB AUTO/PORTABLE	AMERICAN AM/FM/LW AUTO/PORTABLE
ALFA ROMEO 1600/2600	29.50	29.50	34.20	34.20	26.85	35.50
" " GIULIA GIULIETTA	33.50	33.50	41.75	41.75	26.85	40.40
AUSTIN A60	29.50	29.50	34.20	34.20	26.15	35.15
AUSTIN HEALEY SPRITE	33.50	33.50	41.75	41.75	26.15	39.70
CITROEN DS 63/64	25.50	25.50	34.20	34.20	26.85	35.50
" " ID	25.50	25.50	41.75	41.75	26.85	35.50
FIAT 600/700	29.50	29.50	34.20	34.20	26.15	39.70
" 1100/1200/1100S	25.50	25.50	41.75	41.75	26.15	40.05
" 1800B/2100B/2300	21.50	21.50	34.20	34.20	26.85	35.85
FORD ANGLIA	33.50	33.50	41.75	41.75	26.15	39.70
JAGUAR MARK IX	33.50	33.50	41.75	41.75	26.15	39.70
" " MARK X	25.50	25.50	41.75	41.75	26.85	44.85
" " 3.8	17.10	17.10	34.20	34.20	26.85	35.50
" " XKE 62/63	33.50	33.50	48.50	48.50	26.85	44.85
" " XKE 64	29.50	29.50	41.75	41.75	26.85	40.85
MERC.-BENZ 180D/190D	25.50	25.50	34.20	34.20	26.85	44.00
" " 190DC	25.50	25.50	34.20	34.20	26.85	35.55
" " 1800/190	25.50	25.50	41.75	41.75	26.85	58.45
" " 190c	25.50	25.50	41.75	41.75	26.85	60.50
" " 190SL	25.50	25.50	41.75	41.75	26.85	76.25
" " 2200/2200EB	25.50	25.50	41.75	41.75	26.85	64.30
" " 230SL	25.50	25.50	41.75	41.75	26.85	—
MG-B	21.50	21.50	27.00	27.00	26.15	39.70
MG 1100/MIDGET	33.50	33.50	41.75	41.75	26.15	39.70
OPEL KADETT	21.50	21.50	27.00	27.00	26.85	28.35
OPEL REKORD '63	21.50	21.50	27.00	27.00	26.85	33.30
PEUGEOT 404	21.50	21.50	27.00	27.00	26.15	39.70
PORSCHE 356B/c	25.50	25.50	34.20	34.20	26.85	—
RENAULT R-8	29.50	29.50	34.20	34.20	24.35	37.90
" " CARAVELLE/DAUPHINE	29.50	29.50	34.20	34.20	26.15	34.80
SAAB 96	25.50	25.50	34.20	34.20	26.85	44.75
SIMCA 1000	33.50	33.50	41.75	41.75	26.15	39.70
SIMCA 1300	25.50	25.50	34.20	34.20	26.15	34.80
SUNBEAM ALPINE 260	33.50	33.50	41.75	41.75	26.15	39.70
TRIUMPH (ALL MODELS)	33.50	33.50	41.75	41.75	26.15	39.70
VOLVO PV-544	21.50	21.50	27.00	27.00	26.15	35.40
" P-1200/122S	21.50	21.50	34.20	34.20	26.15	35.40
" P-1800	25.50	25.50	34.20	34.20	26.85	35.40
VOLKSWAGEN 1200 SEDAN/CONV.	17.10	17.10	27.00	27.00	24.35	28.35
" TRANSPORTERS	21.50	21.50	27.00	27.00	24.35	39.90
" 1500/1500S	17.10	17.10	27.00	27.00	26.85	28.35
" K. GHIA 1200/1500	17.10	17.10	27.00	27.00	26.85	37.50

Prices under DERBY column include car installation bracket and proper antenna. All other prices include full installation and suppression materials, proper speaker and antenna. Add installation kit price to radio price for total cost of the installation in any car shown.

Kits for many other foreign, domestic cars are available. Prices on request.

POLY PAD IMPORTS

811 PROSPECT AVENUE • CLEVELAND, OHIO 44115



Grand Prix **EXTRACTOR EXHAUST SYSTEMS...**

*made to fit all VW models,
36 & 40 hp...thru '65
Trucks, Wagons, Ghias...*

*...and all push rod
model Porsches.*

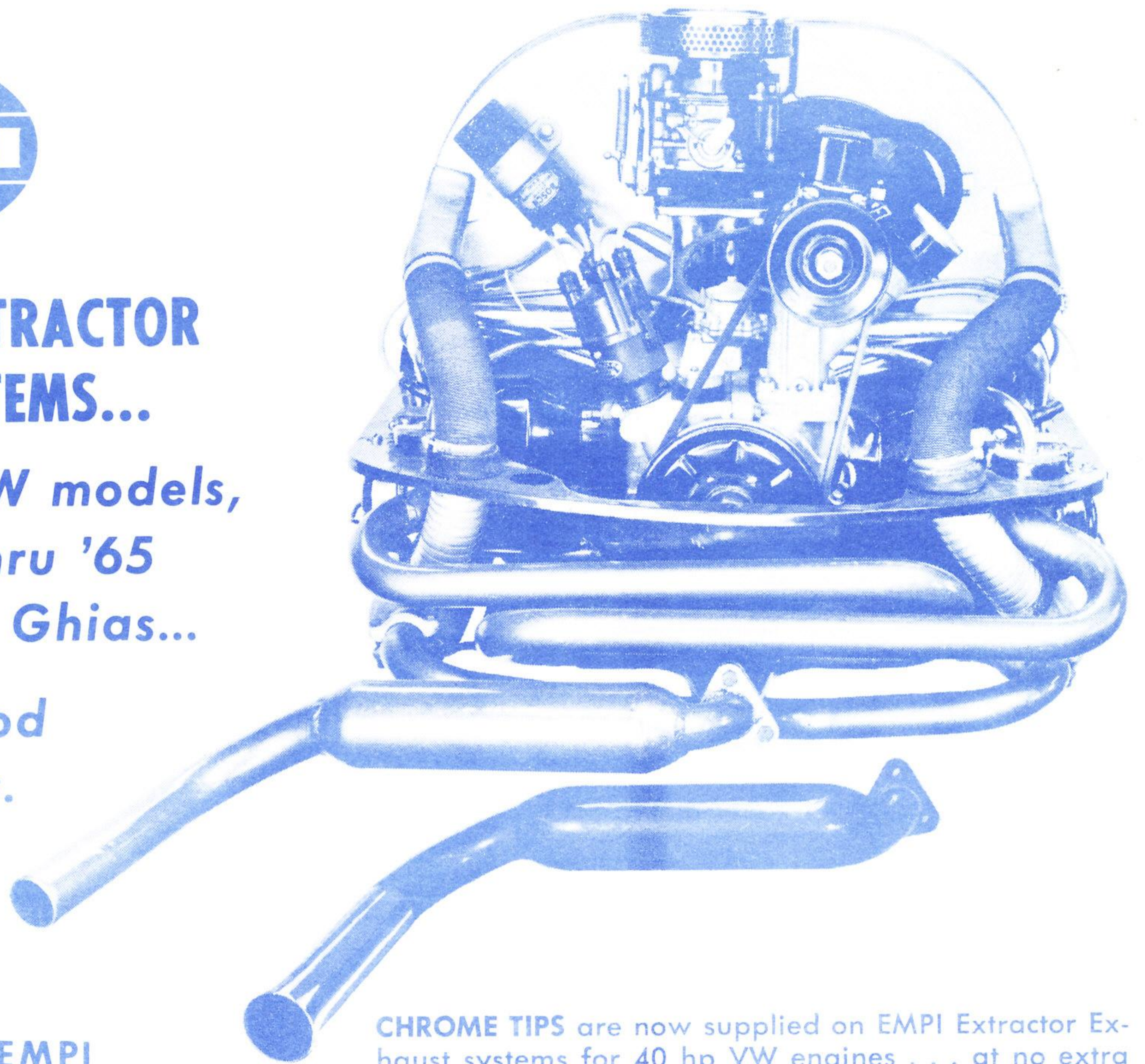

COMPLETE PRICE LIST- EMPI EXTRACTOR EXHAUST SYSTEMS

STOCK NUMBER	MAKE	MODEL and YEAR	EACH
XEMG-100	K. Ghia	40 hp Late '63-'65 (Fresh air heater)	\$49.95
XEMG-101	K. Ghia	40 hp '61-early '63 (old style heater)	49.95
XEMP-110	Porsche	All push-rod models (includes stinger pipe)	59.95
XEMT-120	VW	200 Series Trucks & Wagons with 1500 cc engine	49.95
XEMT-121	VW	1200 with 1500 cc truck engine	49.95
XEMT-122	K. Ghia	1200 with 1500 cc truck engine	49.95
XEMV-130	VW	40 hp late '63-'65 (fresh air heater)	49.95
XEMV-131	VW	40 hp '61-early '63 (old style heater)	49.95
XEMV-132	VW	36 hp	49.95
XSPX-140	"Stinger" Straight Thru Pipe (Specify for which model of muffler)		5.00
SXS-470	Sportster Exhaust System (fits 40 hp VW engine only)		54.95

CHROME TIPS are now supplied on EMPI Extractor Exhaust systems for 40 hp VW engines . . . at no extra cost.

Exhaust gases escape freely, in firing sequence . . . with no build-up of power-robbing back pressure.

Equal-length pipes design gives the high-efficiency extractor effect used in race-car exhaust systems.

Types available to fit both new and old style heater systems on VW and Karmann-Ghia.

Individually engineered, scaled, computed and track-tested for each model VW, Ghia and Porsche.

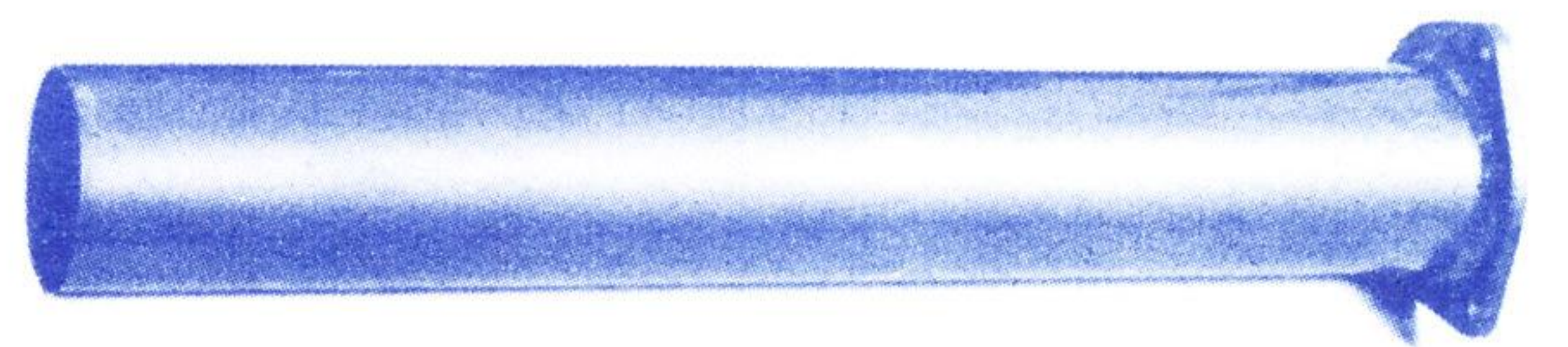

THE CONVERTIBLE "STINGER" PIPE

The convertibility feature of the Extractor Exhausts will appeal to VW owners interested in race and gymkhana-type activities. For ordinary use the Extractor systems feed through a glass-packed muffler, which gives adequate noise suppression for legal street use without developing excessive back pressure. For competition activities requiring maximum power output the muffler may be quickly unbolted and replaced by a straight Stinger Pipe for an additional power gain. Conversion requires only a few minutes.



**NEW...IMPROVED EMPI
BIG-BORE KIT...**
the power bargain!

**15% more H.P.
only
\$98.50**

MORE POWER . . . FOR SATISFACTION PLUS SAFETY!

The simple, quick way to get **MORE POWER** at the **LOWEST COST** is to increase displacement.

EMPI B-B increases displacement from 1192 CC to 1352 CC. . . increases hp by 15%.

Overbore size .200" (5 mm)

Fits all VW 40 HP engines . . . (1192 CC) with stock Crankshafts.

Installed by regular mechanics . . . no special skills required.

HIGHEST QUALITY ALLOY STEEL . . . hand matched and balanced . . . made by Mahle, Germany . . . suppliers for Volkswagen, Mercedes-Benz, Speedwell, Porsche, etc.

NEW, IMPROVED PISTON and RING DESIGN adopted in 1965, assures superior engine compression and minimum oil consumption.

Packed in matched sets, with hand-gapped and fitted rings and pistons. Made to Porsche quality specifications, from superior alloy steel. Designed to cope with the increased load on pistons and cylinders, with more and larger cooling fins, higher quality wrist pins. Uses standard head and base gaskets, standard spigot, standard torque specs. The complete set of pistons, pins, and rings is matched for correct weight.

ORDERING INFORMATION

Kit includes the following components:

- Four matched 82-mm high-performance Mahle cylinders.
- Four fitted alloy pistons with hand-gapped rings
- Four high-strength steel alloy wrist pins

PBBV-100 EMPI Big-Bore Power Kit \$98.50

EPIV-250 Oversize Pistons (82.25 mm) for Big Bore, Complete with rings, pins, etc. per set \$49.80

ERIV-281 Rings, 82 mm, set of 12 \$12.00

811 PROSPECT AVENUE

POLY PAD IMPORTS

CLEVELAND 15, OHIO

Accessories for the Volkswagen Owner

DON'T DISCARD THE CYLINDER HEADS BECAUSE THE GUIDES ARE WORN!

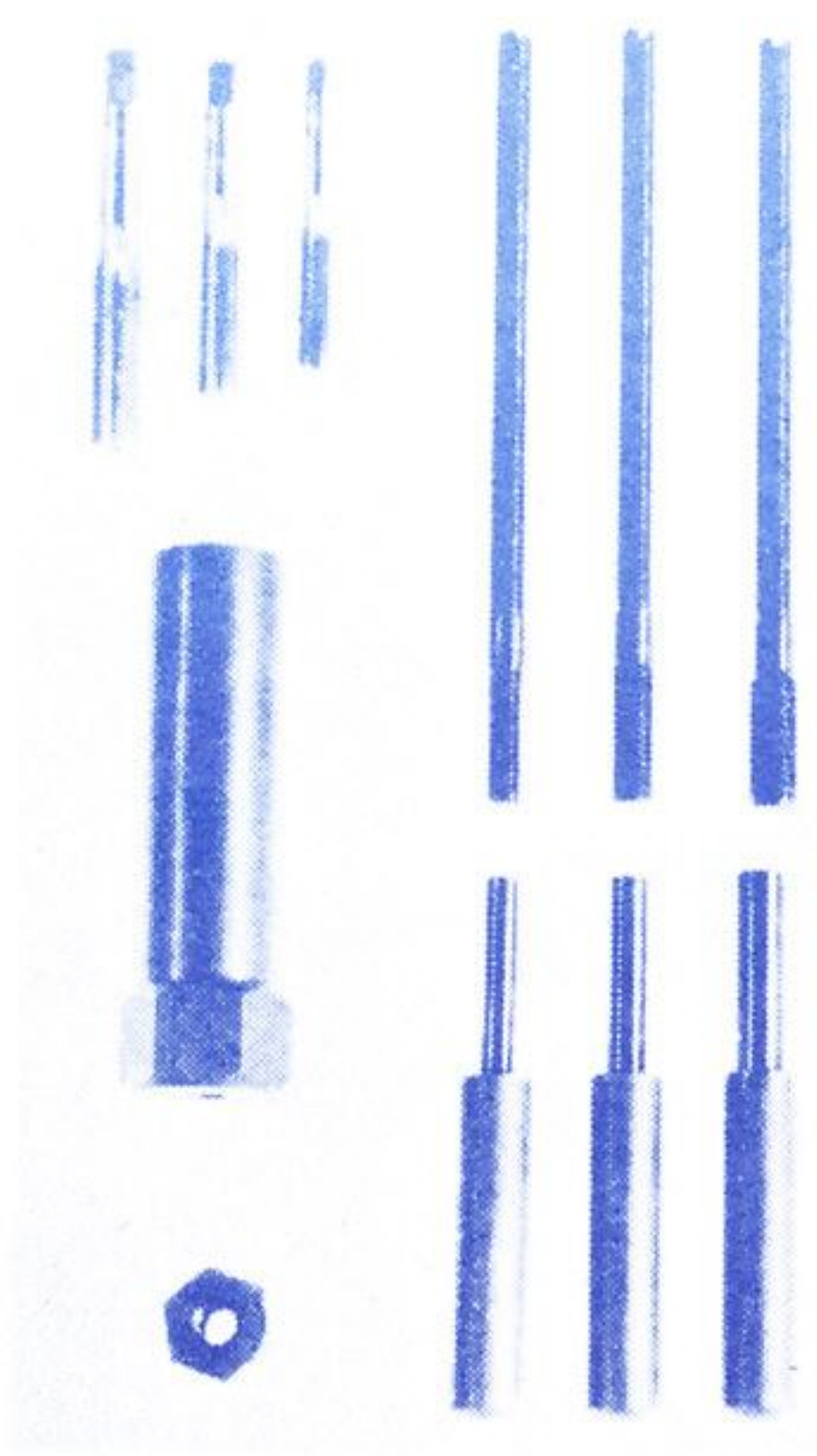

\$19.95

NET

Complete description on reverse side of this page.

Save them with
EMPI's Revolutionary
**VALVE GUIDE
TOOL KIT**
for Volkswagen
and Porsche

You can easily repair a pair of cylinder heads with this equipment in less than 30 min. No heating of the head or chilling of the guide is required..

These tools tested and proven by hundreds of shops in the U.S.A. The guides tested and proven by hundreds of thousands of miles on the roads!

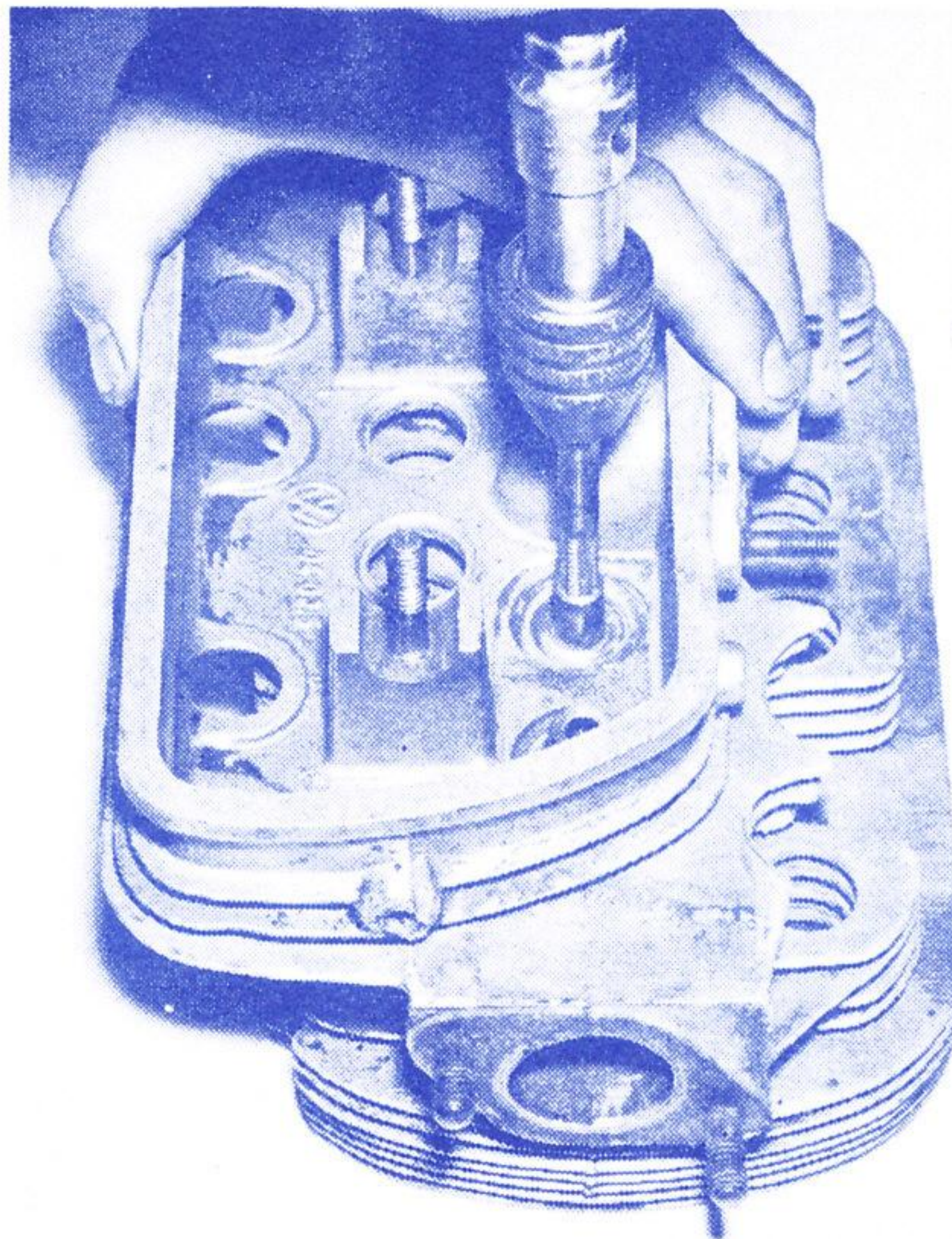

TAPPING WORN GUIDE
VW HEAD



PULLING WORN GUIDE
VW TRANSPORTER HEAD

INSTALLING PORSCHE
EXHAUST GUIDE

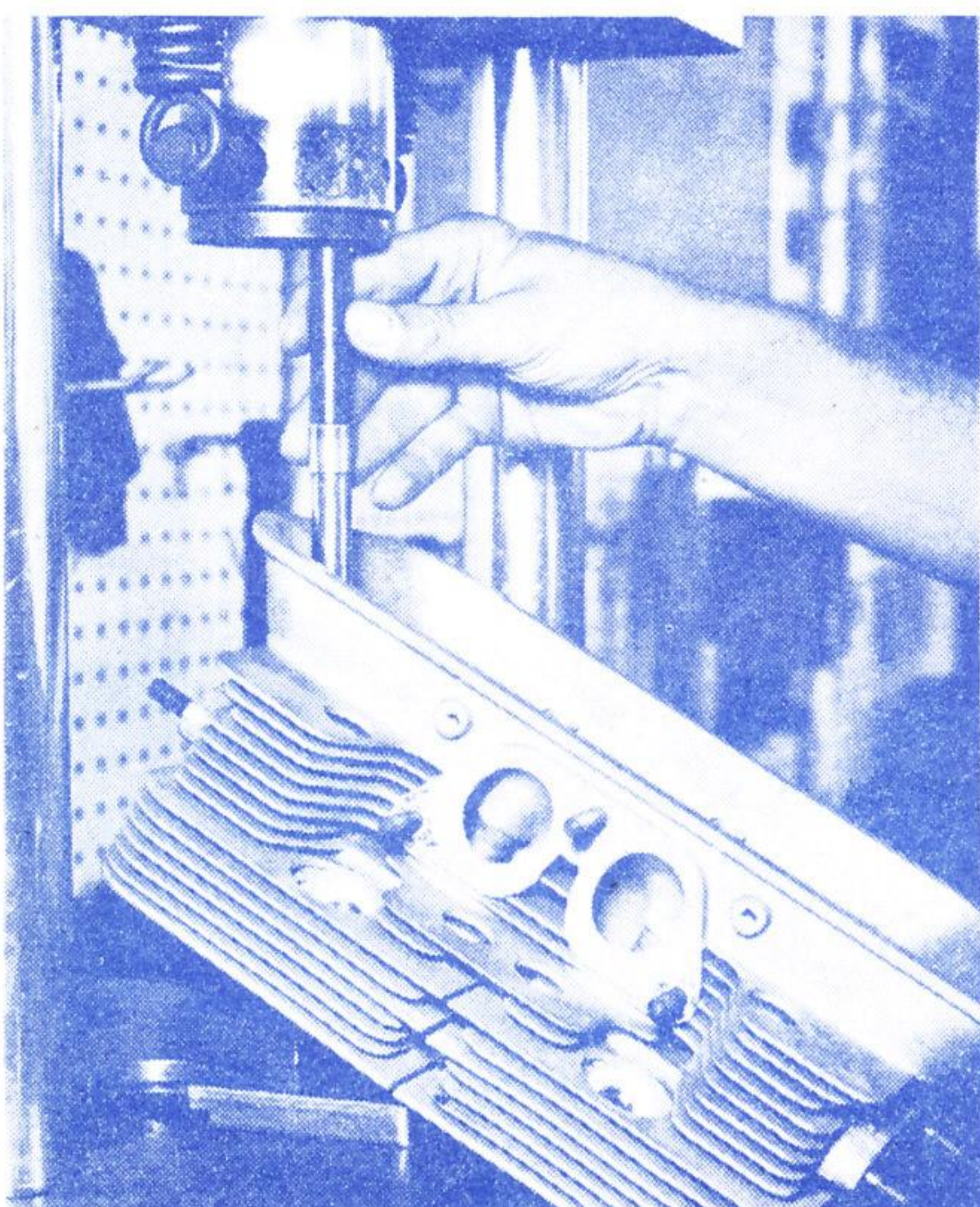

OLD GUIDE OUT
VW HEAD

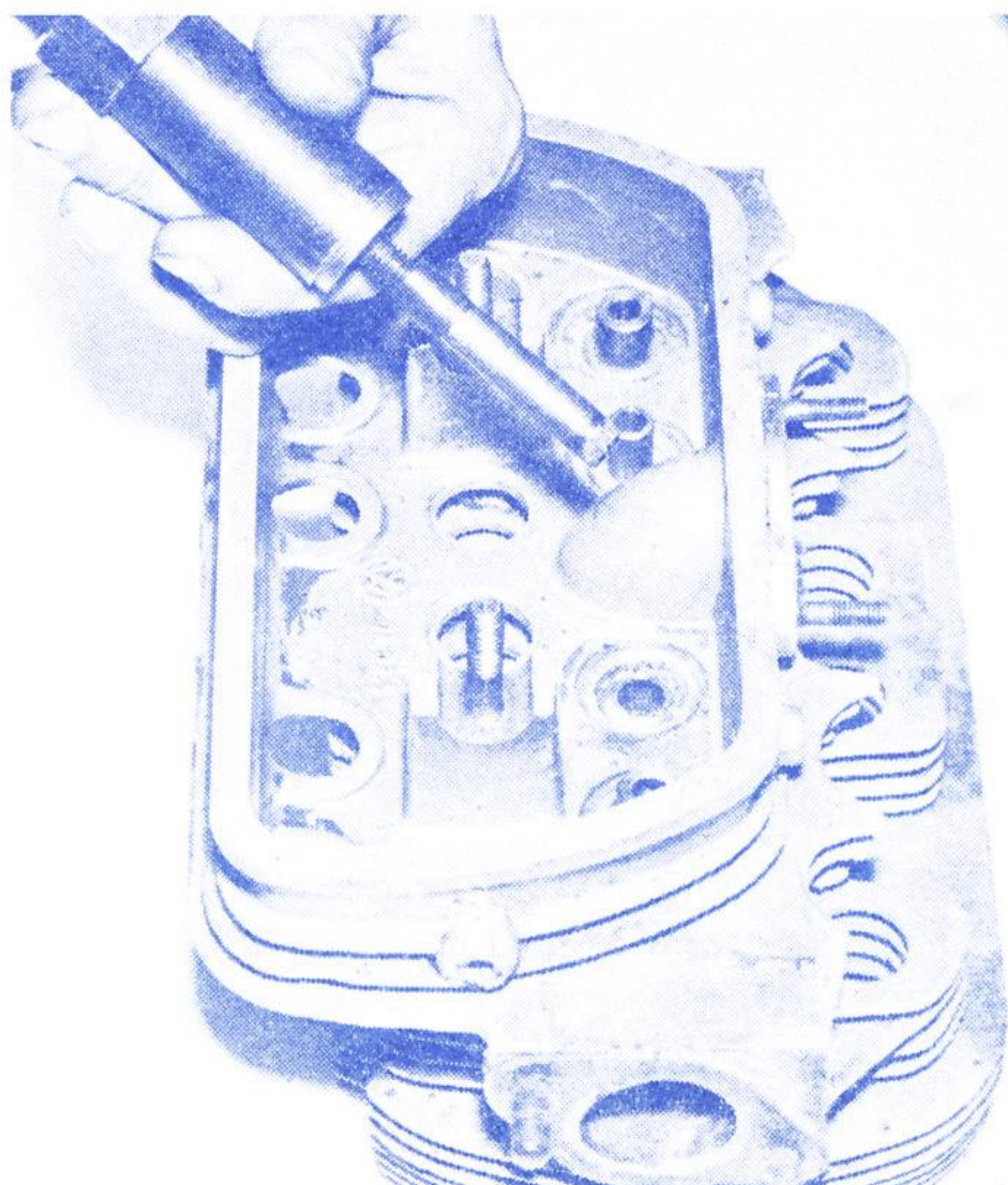

GUIDE ALMOST SEATED
VW HEAD

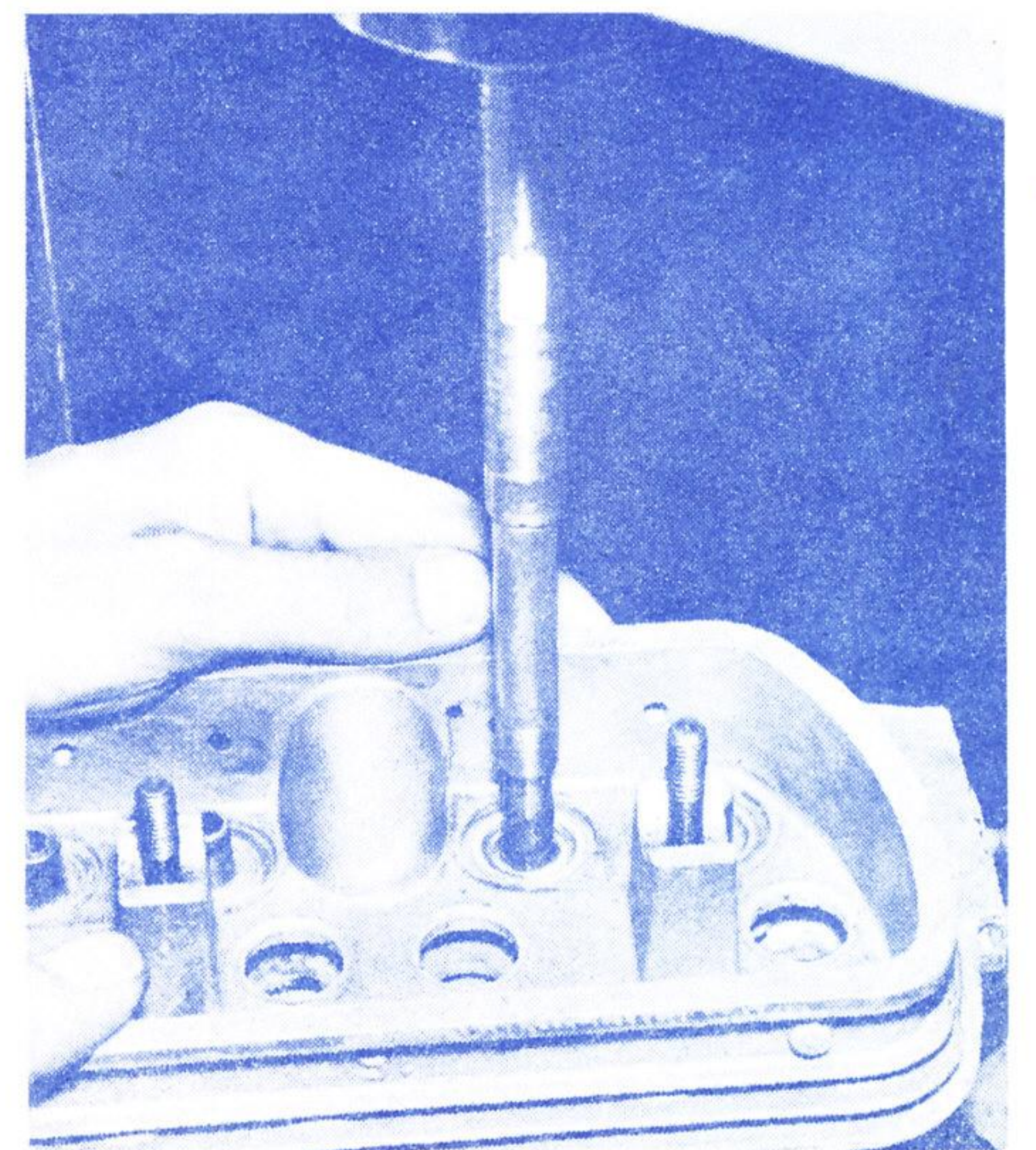

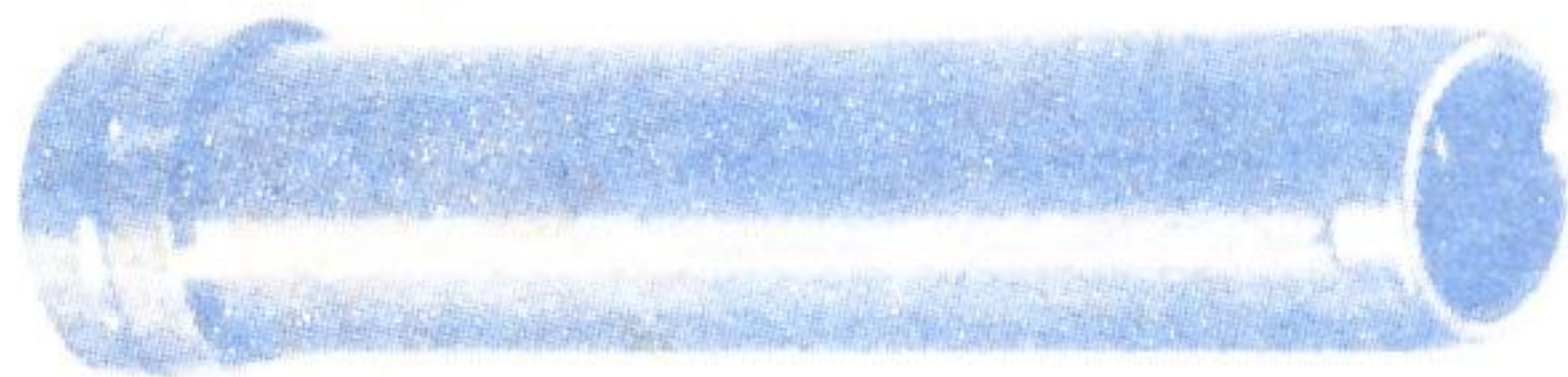

THE WORLD'S FINEST Aircraft Quality Precision Machined Replacement VALVE GUIDES engineered by EMPI for Volkswagen and Porsche

"HUNGER" VALVE GUIDE REAMERS

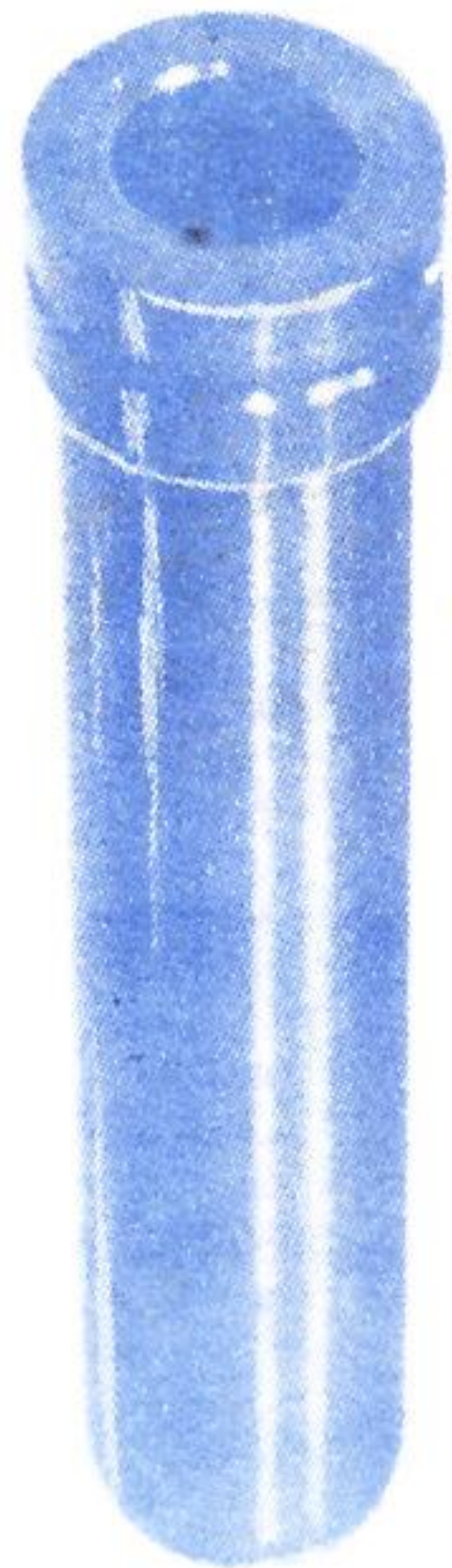
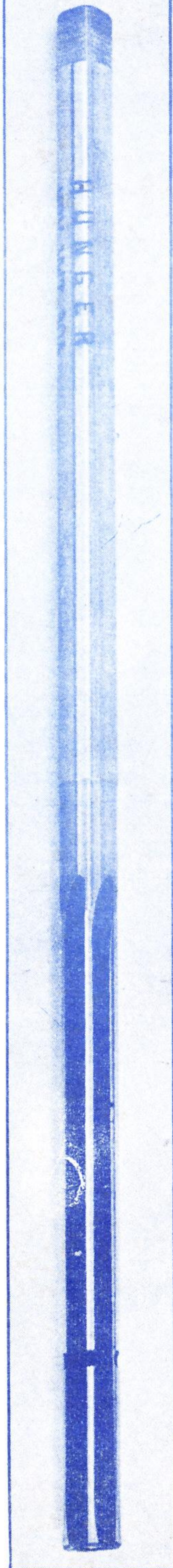

EMPI VALVE GUIDES — ALUMINUM SILICONE BRONZE

Highest quality and strength "Tuf-Stuf" Silicone Bronze, as used extensively in air cooled aircraft engines. Resistant to acid and oxidation at high temperatures. Light weight. Guaranteed superior to original equipment.

REGULAR SIZE	EXHAUST	INTAKE	EACH
36 hp VW.....	EDEV-160	EGIV-170	\$1.90
40 hp VW & all 1500's.....	EGEX-161	EGIX-171	1.90
Porsche.....	EGEP-162	EGIP-172	2.90
OVERSIZE (.005 inches O.D.)			
36 hp. VW.....	EDEV-164	EGIV-174	1.90
40 hp VW & all 1500's.....	EGEX-165	EGIX-175	1.90
Porsche.....	EGEP-163	EGIP-173	2.90



EMPI VALVE GUIDE TOOL KIT

EMPI's Valve Guide Tool Kit enables the mechanic to remove quickly old valve guides and replace them with new guides. No heating or chilling of parts required. For use on Volkswagen 36- and 40-h.p. and Porsche engines. Puller tool may be powered by air wrench, drill press, or hand-operated wrench. Complete kit includes 3 taps, 3 studs, 3 drifts, puller tool, and instructions.

TGTX-150 Valve Guide Tool Kit.....\$19.95 net

Precision REAMERS..the finest!

Approved by the Volkswagenwerk in Germany

Perfect fitting valve guides depend on very close tolerances. You can't do a dependable reaming job with anything but the finest reaming tools, in top condition, without measurable wear. Hunger Reamers are the very finest obtainable, and will do a perfect reaming job every time. We recommend that they be "miked" to check dimension every 6 months, and replaced when worn. Dealers need 4 different reamers on hand for most work. Detailed instructions included.

	EACH, NET
FOR 36 H.P. VW	
TRIV-183 Intake reamer	\$6.95
TREV-181 Exhaust reamer	6.95
FOR 40 H.P. VW and all 1500's.	
TREV-182 Exhaust & Intake	7.95
FOR PORSCHE	
TREP-180 Exhaust & Intake	7.95

ANTI-SEIZE ARMITE (Lead Plate) Aids assembly and disassembly

Lead, mixed with oil and graphite to form a paste . . . eliminates friction.

- For squeezing VW valve guides into the head.
- For coating threads of all studs, to get even torque.
- For muffler gaskets (makes removal easy).

- For pressing on gears.
- For lubricating dies.
- For sealing cylinder heads.

The mechanic's friend . . . makes hard jobs easy.

TAAX-100 — 1 lb. can.....Net \$1.50

